



Fig 1 Transmitter *mag-flux M1*

### Application domain

The *mag-flux M1* is a microprocessor controlled and programmable transmitter that can be customized using control unit (option). Although basic configuration settings such as transmitter calibration are realized at the factory, other settings such as those for measurement data processing, analysis, display and output are user definable.

Measurement data from sensors of series *mag-flux* are processed by the transmitter (hereinafter referred to as *mag-flux M1*). It can be installed directly on the sensor (compact version) or be mounted separately (remote version) and it is designed for flow velocities up to 10 m/s.

A remote version is available for sensor *mag-flux A*, *mag-flux S*, *mag-flux F5* and also for probes *mag-flux MIS 1/D* and *mag-flux MIS 2/15*.

A compact version is only available for sensor *mag-flux A*.

The transmitter *mag-flux M1* is communication enabled and supports optional the HART® protocol.

### Special features

- High-speed signal processing by 16-bit Microcontroller
- Easy multilingual menu navigation with a two-line display (Option)
- Self-monitoring system
- Internal simulation for all output values
- Analog output (0/4-20 mA)
- Digital outputs (pulse, frequency, alarm, forward and reverse flow, MIN / MAX flow rate)
- User settings protected by user definable password

### Introduction

#### I. Shipping, storage and product inspection

##### *Shipping and storage*

The device is to be safeguarded against dampness, dirt, impact and damage.

##### *Product inspection*

Upon receipt of the product, check the contents of the box and the product particulars against the information on the delivery slip and order form so as to ensure that all ordered components have been supplied. Notify us of any shipping damage immediately upon receipt of the product. Any damage claim received at a later time will not be honored.

#### II. Warranty

Your flowmeter was manufactured in accordance with the highest quality standards and was thoroughly tested prior to shipment. However, in the event any problem arises with your device, we will be happy to resolve the problem for you as quickly as possible under the terms of the warranty which can be found in the terms and conditions of delivery. Your warranty will only be honored if the device was installed and operated in accordance with the instructions for your device. Any mounting, commissioning and/or maintenance work is to be carried out by qualified and authorized technicians only.

#### III. Repair

It is important that you do the following before shipping your flowmeter to MECON GmbH for repair:

- Enclose a description of the problem with your device. Describe in as much detail as possible the application and the physical and chemical properties of the fluid.
- Remove any residues from the device and be sure to clean the seal grooves and recesses thoroughly. This is particularly important if the fluid is corrosive, toxic, carcinogenic, radioactive or otherwise hazardous.
- The operator is liable for any substance removal or personal damage costs arising from inadequate cleaning of a device that is sent for repair.

#### IV. Using HART® hand-held terminal

For information regarding operation of the transmitter using the HART® hand-held terminal, see "Operation of the *mag-flux M1* transmitter using the HART® hand-held terminal."

### Steps prior to operation



It is essential that you read these operating instructions before installing and operating the device. The device is to be installed and serviced by a qualified technician only. The *mag-flux M1* transmitter is to be used exclusively to measure volume flow of liquids in conjunction with a sensor of series *mag-flux*.

Downloading of the present document from our web site [www.meccon.de](http://www.meccon.de) and printing out this document is allowed only for purposes of using our flowmeters. All rights reserved. No instructions, wiring diagrams, and/or supplied software, or any portion thereof, may be produced, stored, in a retrieval system or transmitted by any means, electronic, mechanical, photocopying

or otherwise, without the prior written permission of MECON GmbH.

Although the materials in the present document were prepared with extreme care, errors cannot be ruled out. Hence, neither the company, the programmer nor the author can be held legally or otherwise responsible for any erroneous information and/or any loss or damage arising from the use of the information enclosed.

MECON GmbH extends no express or implied warranty in regard to the applicability of the present document for any purpose other than that described.

We try hard to optimize and improve the products and particularly we appreciate any suggestions for improvement made by our customers. If you have any recommendation for improving our products please send your suggestions to the following address:

**Mecon GmbH**  
**Dept. Development**  
**Headword: mag-flux M1**  
**Röntgenstraße 105**  
**D-50169 Kerpen**

or:

**via fax: +49 (0)2237 – 600 06 – 40**  
**via email: [customerservice@mecon.de](mailto:customerservice@mecon.de)**



We reserve the right to change the technical data in this manual in the light of any technical progress that might be made. For updates regarding this product, visit our website at [www.mecon.de](http://www.mecon.de), where you will also find contact information for the MECON distributor nearest to you. For information regarding our own sales operations, contact us at [customerservice@mecon.de](mailto:customerservice@mecon.de).

## Installation and servicing

The devices described in this manual are to be installed and serviced only by qualified technical personnel such as a qualified MECON GmbH electronics engineer or service technician.



### Caution

Before servicing the device, it must be completely switched off, and disconnected from all peripheral devices. The technician must also check to ensure that the device is completely off-circuit. Only original replacement parts are to be used.

MECON GmbH accepts no liability for any loss or damage of any kind arising from improper operation of any product, improper handling or use of any replacement part, or from external electrical or mechanical effects, overvoltage or lightning. Any such improper operation, use or handling shall automatically invalidate the warranty for the product concerned.

In the case of a problem with your device, please contact us using one of the following numbers:

Phone: +49 (0)241 - 41369 - 0  
Fax: +49 (0)241 - 41369 - 40

Contact our customer service department if your device needs repair or if you need assistance in diagnosing a problem with your device

## Safety advisory for the user

The present document includes all information you need for proper operation of the product. The document is intended for use by qualified personnel. This means personnel who are qualified to operate the device described herein safely, including

- electronics engineers,
- electrical engineers
- service technicians

who are conversant with the safety regulations pertaining to the use of electrical and automated technical devices and with the applicable laws and regulations in their own country. The personnel must be authorized by the facility operator to install, commission and service the product described herein, and are to read and understand the contents of the present operating instructions before working with the device.

## Hazard warnings

The purpose of the hazard warnings listed below is to ensure that device operators and maintenance personnel are not injured and that the flowmeter and any devices connected to it are not damaged.

The safety advisories and hazard warnings in the present document to avoid injury of placing operators and maintenance personnel and to avoid material damage are prioritized using the terms listed below, which are defined as follows

### Danger

means that failure to take the prescribed precautions **will result** in death, severe bodily injury, or substantial material damage!

### Warning

means that failure to take the prescribed precautions **could result** in death, severe bodily injury, or substantial material damage!

### Caution

means that failure to take the prescribed precautions could result in light severe bodily injury or material damage!

### Note

means that the accompanying text includes important information about the product, handling the product or about a section of the documentation that is of particular importance.

### Proper use of the device



#### Caution

The operator is responsible for ensuring that the material used in the sensor and housing is suitable and that such material meets the requirements for the fluid being used and the ambient site conditions. The manufacturer accepts no responsibility in regard to such material and housing.



#### Caution

In order for the device to perform correctly and safely, it must be shipped, stored, set up, mounted, operated and maintained properly.

### Return for servicing or calibration

Before returning your flowmeter for servicing or calibration, make sure it is completely clean. Any residues of substances that could be hazardous to the environment or human health are to be removed from all crevices, recesses, gaskets, and cavities of the housing before the device is shipped!



#### Caution

The operator is liable for any loss or damage of any kind, including personal injury, decontamination measures, removal operations and the like that are attributable to inadequate cleaning of the device.

**Any device returned for servicing is to be accompanied by a certificate as specified in „Product return form“!**

The device is to be accompanied by a document describing the problem. Please also quote the name of a contact person. This will help to repair your device as expeditiously as possible and therefore minimize the cost of repairing it.

### Replacement of the transmitter electronics

Before replacing the transmitter electronics, read the safety instructions in Section „ Replacement of transmitter electronic“ on page 12.



#### Caution

Make sure that you obey the applicable standards and regulations pertaining to electrical devices, device installation and process technology when replacing the transmitter electronics. The highly integrated electronic components of the device are ESD sensitive.



#### Caution

The complete unit has to be replaced with all of its printed boards (except for the memory chip (DSM)). The specified precision and interchangeability of the electronics are only guaranteed if the complete insert is replaced.

### Identifikation

Manufacturer	Mecon GmbH Zieglerstraße 10-16 D-52078 Aachen Phone: +49 (0)241 4 13 69 - 0 Fax: +49 (0)241 4 13 69 - 40 Internet: <a href="http://www.mecon.de">http://www.mecon.de</a> email: <a href="mailto:customerservice@mecon.de">customerservice@mecon.de</a>
Product type	Transmitter for magnetic-inductive flowmeters
Product name	Transmitter Type <i>mag-flux M1</i> , suitable for magnetic-inductive flowmeters series <i>mag-flux</i>
Versions-Nr.	2.2 vom 08.01.2010

### Commissioning

#### Installation of magnetic-inductive flowmeters

At the installation of the magnetic-inductive flow sensor the instructions and notes of the assembly instructions and operating manuals have to be followed. Also, observe the regulations of grounding, potential equalization and company-internal grounding guidelines.

#### Potentials

All outputs are electrically isolated from the auxiliary power, the sensor circuit and from each other. The housing and the interference suppression filters of the power supply are connected to PE.

The electrodes and measuring electronics are related to the potential of the function earth FE of the sensor. FE is not connected to PE, but may be connected with each other in the sensor junction box. If the sensor is grounded by using ground disks (earthing rings), these must be connected with the function earth FE.

At a separate assembly of sensor and transmitter the outer screen of the connecting cable is connected to the transmitter housing and has PE potential. The inner screens of the electrode line are connected to FE inside the junction box of the sensor and to the mass (GND) of the transmitters electronic.

Details of all wirings, terminals and drawing can be found in the chapter „Wiring diagrams“ starting at page 9.

#### Cathodic protective units

Using a cathodic protective unit to avoid corrosion, which put a voltage to the tube wall, it must be connected to terminal FE. The transmitter boards, control panel and internal switches are on the same potential as FE.

## Transmitter mag-flux M1



### Caution

According to EN 50178:1997 all electrical circuits with „protectiv safety isolation without any protection against contacts“ must observe the following maximum voltages:

- Maximum AC voltage ( $V_{\text{eff}}$ ) 25 V
- Maximum DC voltage 60 V

**It is strictly forbidden to connect FE to any higher voltage!**

### Zero point calibration

In order to ensure that precise measurements are obtained, zero point calibration is to be realized the first time the device is put into operation and before any regular operations are carried out. Zero point calibration is to be carried out using a fluid.

The zero calibration procedure is as follows:

- Install the sensor as described in the manual.
- Check to ensure that the sensor is completely filled with fluid and that there are no gas bubbles in the flow tubes.
- Set the process conditions such as pressure, temperature and density.
- Close the cut-off device behind the sensor.
- Operate the transmitter in accordance with the instructions in chapter „Zero point adjustment“ on page 11 for the basic version or chapter „Zero point calibration“ on page 20 for the version with the control panel.
- Make sure that sufficient time is allowed for the electronics to warm up.
- Allowing fluid to flow through the sensor during the zero calibration procedure will skew the zero point and result in false readings.

### Startup conditions

The device is not subject to specific startup conditions. However, pressure surges should be avoided.

### Commissioning the mag-flux flow probes

In order to be able to calculate the volume flow when using the mag-flux flow probes correctly from the measured flow velocity, the installation requirements must be kept regarding position and mounting depth correctly.



Transmitter settings must be made as specified in chapter „Operating the mag-flux flow probes with the mag-flux M1“ on page 6 to ensure the correct operation!

Particularly for existing installations after replacements or modifications e.g. tubing diameter.

## Operating principle and system design

### Measuring principle

It was back in 1832 that Faraday suggested utilizing the principle of electrodynamic induction for measuring flow velocities. His experiments in the Thames, though unsuccessful due to superimposed polarization effects, are nonetheless regarded as the first experiment in the field of magnetic-inductive flow measurement. According to Faraday's law of electromagnetic induction, an electrical field  $E$  is generated in a conductive liquid moving through a magnetic field  $B$  at a velocity  $v$  in accordance with the vector product  $E = [v \times B]$ .

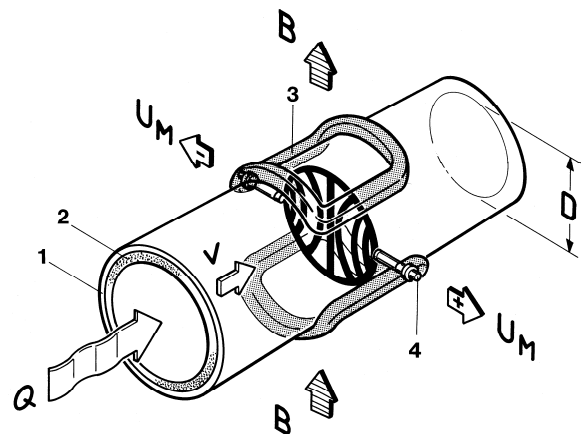


Fig 2 Principle of the magnetic-inductive flow measurement

Through a meter tube provided with an insulating lining a liquid flows at velocity  $v$  and a flow rate  $Q$ , producing a measuring-circuit voltage  $U_m$  at the two electrodes at right angles to the direction of flow. The size of this measuring-circuit voltage is proportional to the mean flow velocity and the volume flow rate.

### System design

The meter consists of a mag-flux M1 transmitter and a sensor e.g. mag-flux series. The device can be used to perform measurements with any liquid, conductive media, providing that the sensor's material is suitable for the product being used.

The mag-flux M1 transmitter generates the inductive current necessary for the magnetic field and preprocesses the induced voltage at the electrodes.

### Basic version *mag-flux M1*

An analog 0/4...20 mA current output (active), a pulse or frequency output and a status output are standard features of the device.

A green LED is an operational readiness indicator, error are indicated by a red light and reverse flow by a yellow light.

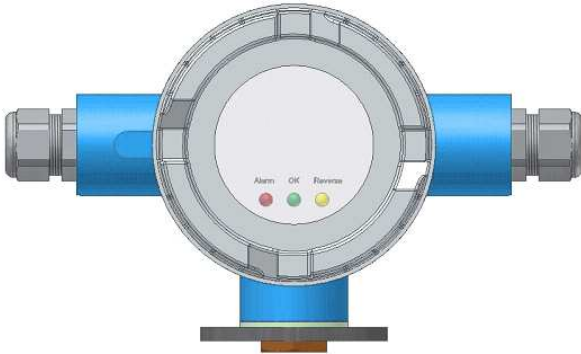


Fig 3 Basic version of the transmitter *mag-flux M1*

### HART®-interface (Option)

An analog 0/4–20 mA output is a standard feature and digital data transmission via HART® protocol as an optional feature of the device.

A retrofit by customer is not possible.

### LCD display (Option)

Instead of the three light indicators, a LCD display with backlight is an optional feature. The display shows measured values as well as diagnostics. With 6 keypads customers are able to configure comfortable and simple the transmitter without any other tool.

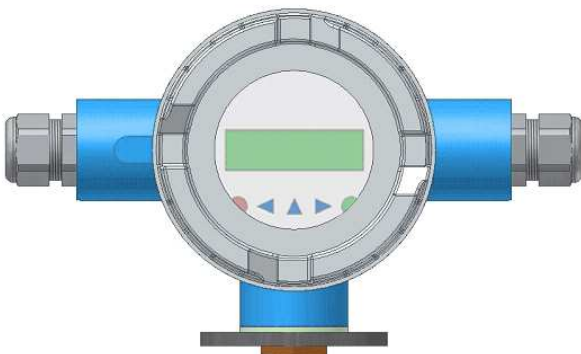


Fig 4 Transmitter with integrated LCD display

### Empty pipe detection

Transmitters, which are equipped with a LCD display, have the ability for a empty pipe detection. The operating reliability depends on the conductivity of the liquid medium and the cleanliness of the electrodes. As higher the conductivity is, as more reliable operates the empty pipe detection.

Insulation coatings on the electrodes surface worse the empty pipe detection.

### Data memory chip (DSM)

The replaceable data memory chip (DSM) is an EEPROM device in DIL-8 housing, located in a socket on the power supply board. It includes all characteristic data of the sensor e.g. sensor constant, version or serial number. Consequently, the memory module is linked to the sensor and in case of a transmitter replacement it has to remain by the sensor!

After replacing the transmitter or its electronics, the DSM will be installed in the new transmitter. After the measuring system has been started, the measuring point will continue working with the characteristic values stored in the DSM. Thus, the DSM offers maximum safety and high comfort when exchanging device components.

### Slot DSM

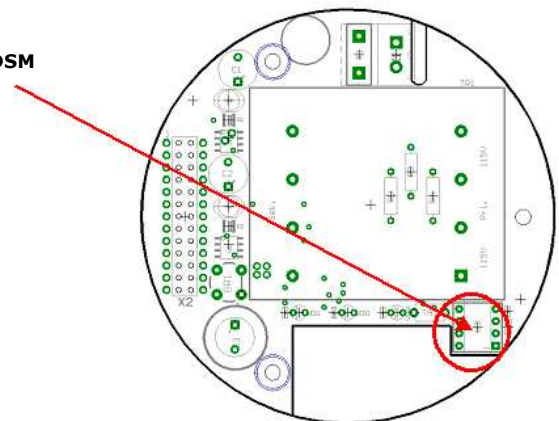


Fig 5 Electronic, Power supply board *mag-flux M1*

At any exchange observe the polarity of the memory chip. Pin 1 is signed by a dot or a notch.

### Safety of operation

A comprehensive self-monitoring system ensures maximum safety of operation.

- Potential errors can be reported immediately via the configurable status output. The corresponding error messages will also be displayed on the transmitter display. A failure of the auxiliary power can also be detected via the status output.
- When the auxiliary power fails, all data of the measuring system will remain in the DSM (without back-up battery).
- All outputs are electrically isolated from the auxiliary power, the sensor circuit and from each other.

## Input

### Measured variable

Mass flow rate, temperature, density and volume flow (calculated from the preceding measured variables).

### Measuring range

The measuring range, which varies according to which sensor is used, can be found on the relevant data sheet or rating plate.

### Operating the mag-flux flow probes with the mag-flux M1

The flow probes *mag-flux* MIS 1/D und *mag-flux* MIS 2/15 are calibrated for flow velocity. In order to display the measured value in volume flow units, it must be converted using the flow velocity and the inside diameter of the tube. The following parameters must be set at the *mag-flux* M1:

1. At the functional level `SENSORSETTINGS + M1` set the sensor type *mag-flux* MIS. The dimension of the sensor constants will be automatically adapted.
2. Setting of the sensor constant.
3. Set the Inside diameter of the tube in xxx mm.



#### Important

The actual diameter has to be set, not the nominal diameter of the tube!

4. At the functional class `FLOW`, set the desired unit of volume flow.
5. Using the function `VOLUME FLOW UPPER-RANGE VALUE` set the upper-range value

## Output

### Output signal

#### All signal outputs

Electrically isolated from each other and from ground (PE).

#### Analog output

- 0/4-mA current output, electrically isolated, optional with HART®
- Volume flow or flow speed (Using the HART®-protocol the current output has to be assigned to volume flow in the mode of 4-20mA)

#### Pulse-/Frequency output

- Pulse duration adjustable range is 0,1 ... 2000 ms (default value 50 ms)  
(Mark-to-space ratio is 1:1, if the set pulse duration is not reached.)



#### Important

When programming the pulse duration, a plausibility check is carried out. If the selected pulse duration is too long for the set upper range value, an error message will be displayed.

- frequency output max. 1 kHz
- passive via optocoupler

$U_N = 24V$   
 $U_{max} = 30 V$   
 $I_{max} = 60 mA$   
 $P_{max} = 1,8 W$

### Pulse value

The pulse value can be multiplied by a factor between 0.001-100.0 (decade increments) of the selected pulse unit (e.g. m<sup>3</sup>)

Default: 1 pulse/unit

### Status output

- for: - forward and reverse flow,
  - MIN flow rate
  - MAX flow rate
  - alarm

- passive via optocoupler

$U_N = 24 V$   
 $U_{max} = 30 V$   
 $I_{max} = 60 mA$   
 $P_{max} = 1,8 W$

### Failure signal

A failure in the meter can be indicated via the current output or the status output. The current output can be set to a failure signal (alarm) of  $I < 3.8 mA$  or  $I > 22 mA$ .

The status output can be configured as N/O or N/C contact.

### Load for the current output

Standard version:  $\leq 600 \text{ Ohm}$   
HART® (minimum load)  $> 250 \text{ Ohm}$

### Damping

Programmable from 0 to 60 seconds

### Low flow cut-off

The low-flow cut-off can be set to values between 0 and 20%. The set value refers to the upper range value. If the measured value is lower than the set volume, the flow rate will set to 0.0 (l/h). This results in the analog output being set to 0/4 mA, and the pulse output will stop generating pulses.

The configurable hysteresis takes effect only one side while exceeding this limit.

### Technical data

#### Reference conditions

In conformity with IEC 770:

temperature:	T = 20°C
relative humidity:	rH = 65%,
air pressure:	p = 101,3 kPa

#### Measuring tolerance

See characteristic values of the corresponding sensor.

#### Repeatability

See characteristic values of the corresponding sensor.

#### Influence of ambient temperature

- For the pulse output:  $\pm 0,05\%$  per 10 K.
- For the current output:  $\pm 0,1\%$  per 10 K.

### Operating conditions

#### Installation conditions



#### Caution

Additional cable glands (not contained):  
The operator is responsible for that fact that according to the enclosure and ignition enclosure certified cable glands or screws are used. The kind of threads is stamped on the rating plate.  
At the connection between sensor and transmitter a metalized cable gland must be used for the screen.  
(See chapter „Connection of the magnetic current and electrode line on page 9)

#### Compact version

For the compact version the transmitter housing is mounted on the sensor. Therefore no cable is necessary between sensor and transmitter.

#### Remote version

The transmitter needs to be mounted separately from the sensor if:

- the mounting area is difficult to access,
- there is a lack of space,
- medium and ambient temperatures are extremely high,
- there is strong vibration.

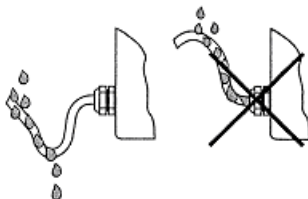


Fig 6 Proper installation of cables at high humidity and wet conditions

The *mag-flux M1* transmitter has to be mounted free of vibrations!



#### Caution:

For the separate version, the minimum permissible conductivity of the medium is determined by the distance between the sensor and the transmitter. The maximum cable length to ensure accuracy is 200 m. For the cable type see chapter „cable specification“ on page 9.

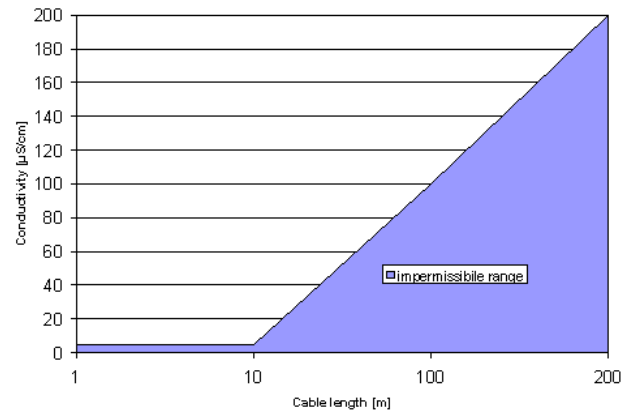


Fig 7 Cable length for remote version

#### Important



- The electrode cable must be fixed. If the conductivity of the medium is low, cable movements may change the capacity considerably and thus disturb the measuring signal.
- Do not lay the cables close to electrical machines and switching elements.
- Equipotential bonding must be ensured between sensor and transmitter.



#### Caution

Do not connect or disconnect the field coil cable before the primary power of the meter has been disconnected!

### Environmental conditions

#### Ambient temperature range

- 20 °C to + 60 °C (-4°F to 140°F).

Below 0 °C the readability of the LCD display will be limited.

In the case of an outdoor installation, the device must be protected against direct solar irradiation with a weather shield

#### Storage temperature

- 25 °C to + 60 °C (-13 °F to 140 °F)

#### Degree of protection

IP67.

**Caution**

Ingress protection IP 67 is only achieved if suitable and tightly screwed down cable glands or conduits are used. If the cable glands are only tightened manually water may leak into the terminal compartment in the housing.

**Danger**

Particular care must be taken if the front window of the housing becomes fogged over or discolored because moisture, water or product might seep through the wire sheath into the terminal compartment in the housing!

**Caution**

Electromagnetic compatibility is only achieved if the electronics housing is closed. Leaving the enclosure open can lead to electromagnetic disturbances.

**Process conditions****Fluid temperature**

The data sheet/rating plate of the connected transmitter is binding. With directly mounted transmitter on the sensor (compact version) the heat entry from the process to the transmitter must be considered.

**Phase of Medium**

Liquid.

**Viscosity**

No restrictions.

The data sheet/rating plate of the connected sensor is binding.

**Fluid temperature limit**

The data sheet/rating plate of the connected sensor is binding.

**Flow rate limit**

The data sheet/rating plate of the connected sensor is binding.

**Pressure drop**

The data sheet/rating plate of the connected sensor is binding.

**Empty pipe detection**

Transmitters, which are equipped with a LCD display, have an selectable empty pipe detection. The operating reliability depends on the conductivity of the liquid medium and the cleanliness of the electrodes.

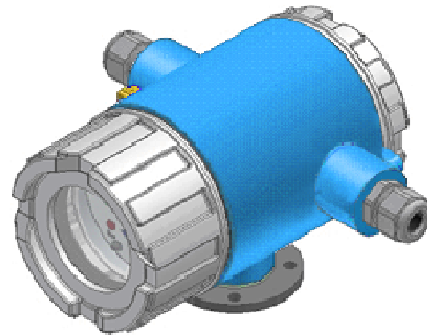
**Construction details****Type of construction / dimensions**

Fig 8 Transmitter housing – compact version

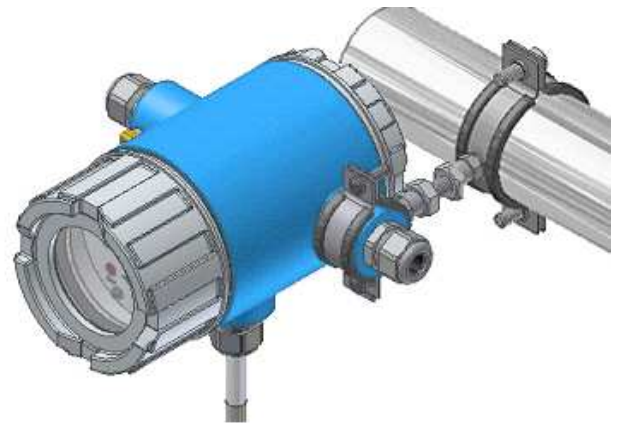


Fig 9 Transmitter housing – pipe mounting

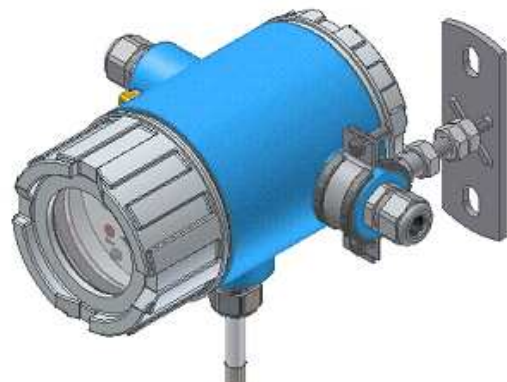


Fig 10 Transmitter housing - wall mounting

### Technical data mag-flux M1

Weight:	2,4 kg								
Material:	aluminum die-cast housing, powder-coated								
Process connection:	Directly mounted on the sensor (compact version) or connected via cable (remote version).								
Electrical connection:	Mains 230 V AC; -15%/+10%, 50/60 Hz 115 V AC; -15%/+10%, 50/60 Hz or 24 V DC; ± 15 %								
Power consumption:	10 VA								
Mains fuse:	5 x 20mm (acc. DIN 41571-3) Rated voltage: 250V AC Braking capacity: 80A@250V AC								
	<table border="1"> <thead> <tr> <th>Mains</th> <th>Rated current</th> </tr> </thead> <tbody> <tr> <td>250 V AC</td> <td>100 mA (T)</td> </tr> <tr> <td>115 V AC</td> <td>100 mA (T)</td> </tr> <tr> <td>24 V DC</td> <td>1 A (T)</td> </tr> </tbody> </table>	Mains	Rated current	250 V AC	100 mA (T)	115 V AC	100 mA (T)	24 V DC	1 A (T)
Mains	Rated current								
250 V AC	100 mA (T)								
115 V AC	100 mA (T)								
24 V DC	1 A (T)								

### Electrical terminals

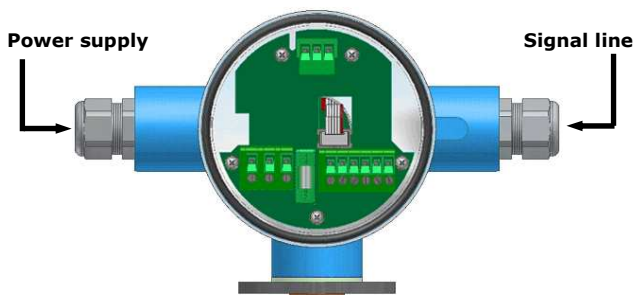


Fig 11 Electrical connections of the transmitter *mag-flux M1*

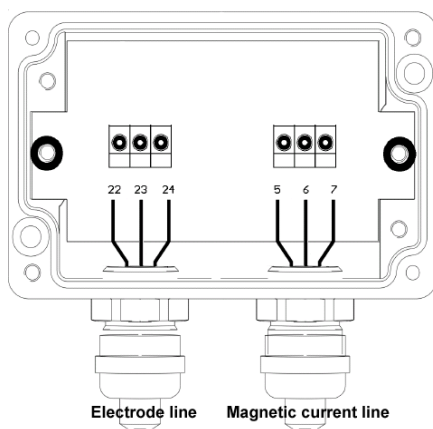


Fig 12 Electrical connection of the *mag-flux M1*  
(remote version only)

### Cable specification

If the transmitter is mounted separately from the sensor, the following cables must be used:

#### Electrode cable and field coil cable

as shielded twisted pair. In order to protect the cable from external interference, the twisted-pair wires are covered by an additional, overall shield.

Cable length	wire cross section	Example
≤ 10 m	≥ 0,25 mm <sup>2</sup>	LIYCY-CY TP 2x2x0,25 mm <sup>2</sup> .
> 10 m	≥ 0,75 mm <sup>2</sup>	SLIYCY-C11Y (2x(2x0,75 mm <sup>2</sup> )).

The outer shield is grounded by means of special EMC-compliant cable glands at both ends of the cable.

### Wiring diagrams

#### Connection of the signal cables

- Lay the signal cables separately from cables with voltages > 60 V.
- Only use signal cables as specified in chapter „Electrode cable and field coil cable“.
- Avoid laying signal cables close to large electrical installations or use – if possible – only shielded cables.
- A load at least 250 Ω must exist in the signal circuit for error free communication via the HART® protocol.

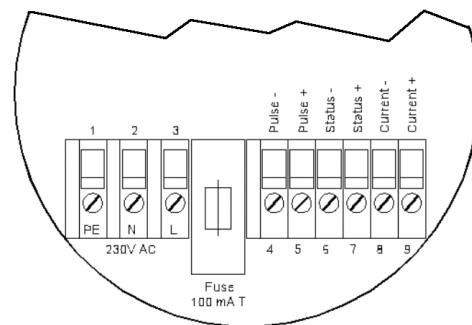


Fig 13 Mains and signal terminals of the transmitter *mag-flux M1*

Terminal	Label	Function
1	PE	Protective conductor
2	N	Mains
3	L	Mains
4	Pulse -	Pulse output (passive)
5	Pulse +	Pulse output (passive)
6	Status -	Status output (passive)
7	Status +	Status output (passive)
8	Current -	Current output (aktive)
9	Current +	Current output (aktive)

### Connection of the magnetic current and electrode line (remote version only)

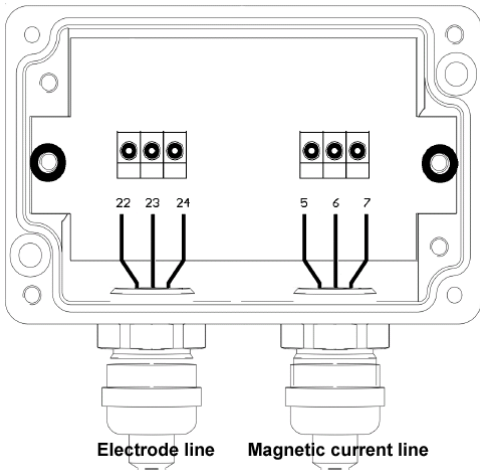



Fig 14 Connection diagram for sensor cable of the *mag-flux M1*

Terminal	Function
5	Magnetic field current 1
6	Magnetic field current 2
7	Potential equilization / PE
22	Measuring ground
23	Electrode 1
24	Electrode 2

For cable specifications see chapter „Electrode cable and field coil cable“ on page 9.  
The outer shield is grounded by means of special EMC-compliant cable glands at both ends of the cable, the inner shields are connected to terminal 7 and 22 respectively.

For terminal assignments see „Electrical terminals“ on page 9.



**Caution**  
Do not connect or disconnect the field coil cable before the primary power of the meter has been disconnected!

Please observe also the advices in chapter „**Cable specification**“ on page 9

### Connection of the sensor mag-flux A

The remote version of the sensor *mag-flux A* has a terminal box as shown in Figure 15.

Feed the electrode line through the left gland and the magnetic current line through the right gland and connect the cables as shown in Figure 15.

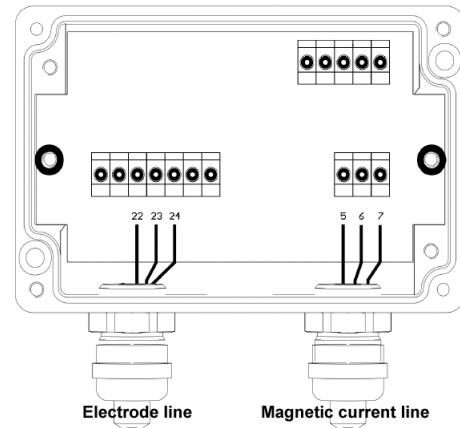


Fig 15 Electrical connections of the *mag-flux A* sensor

### Connection of the sensor mag-flux F5

Feed the electrode line through the lower gland as shown in Figure 16 and the magnetic current line through the upper gland (see Figure 17) and connect the cables.

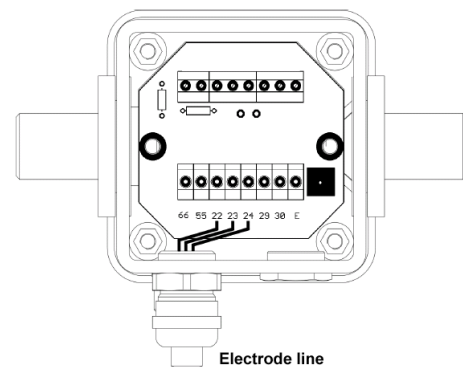


Fig 16 Electrical connections of the *mag-flux F5* sensor (bottom)

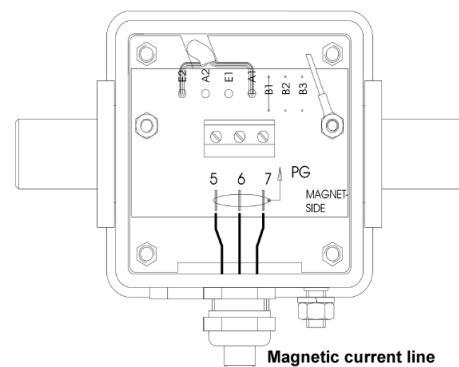


Fig 17 Electrical connections of the *mag-flux F5* sensor (top)

### Connection of the sensor *mag-flux S* and the flow probes *mag-flux MIS*

These sensors are equipped with a pre-assembled cable ex-factory. This cable is permanently connected to the sensor at one end. The end leading to the transmitter is fitted with a cable gland and pre-prepared cable ends for connection. The attached wire numbers serve for orientation.

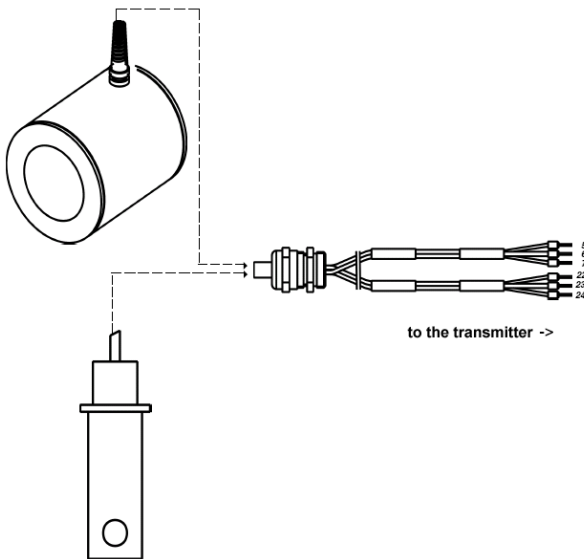


Fig 18 Connections of the sensor *mag-flux S* and the probes

### Anschluss HART®

A number of options are available for HART® communication. However, for all these options loop resistance must be less than the maximum load specified in Chapter „Outputs“ (see page 6). The HART®-Interface is connected via terminals 8 and 9 of the (active) current output. The minimum load impedance is 250Ω.

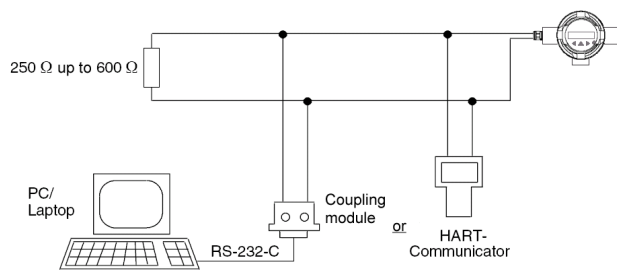


Fig 19 Electrical connection for HART® communication, schematic diagram

### Display and operator interface (basic version)

#### Zero point adjustment

Below the mains transformer, next to the lights and the data storage module (DSB), there is a switch for adjusting the zero point. In order to reach the switch, the transducer must be opened by unscrewing the front cover and removing the decoration foil.

For processing the zero point adjustment please observe the advices in Section “Zero point calibration” on page 4.

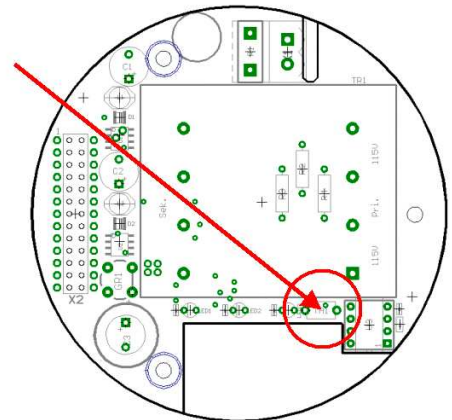


Fig 20 Switch for zero point adjustment

#### LED display

The actual operating status information of the *mag-flux M1* is displayed by three LED for the basic version:



Fig 21 Status-LED of the *mag-flux M1* (basic version)

green LED	off	Not powered
	flashing	Power on
yellow LED	off	Flow direction forward
	on	Flow direction reverse
red LED	off	Normal operation
	flashing	Limit exceeded
	on	Malfunktion

## Maintenance and repair

The transmitter *mag-flux M1* is designed for maintenance-free performance. It contains no parts, which have to be replaced or adjusted cyclically.

While commissioning or maintenance, mains power must be switched off. Do not connect or disconnect the wiring between sensor and transmitter while power is on!

### Mains fuse

The mains fuse is located in the terminal compartment. Before replacing the fuse, the power has to be switched off. Check carefully that the transmitter is voltage free. The fuse may only be replaced by the exactly same type of fuse! (See also chapter „Technical data *mag-flux M1*“ on page 9).

### Replacement of terminal board

The terminal board is located in the terminal compartment. Before replacing the board, the power has to be switched off. Check carefully that the transmitter is voltage free. The board may only be replaced by the exactly same type of board.

To replace the terminal board, all pluggable connectors have to be released first and the 4 fixing screws have to be loosened.

For the assembly of the new board ensure, that the screws are secured again by toothed washers. Only after all connectors are plugged in, the power can be switched on again

### Replacement of transmitter electronic

The transmitter electronic may be replaced only as complete module. With the exchange of individual components the transmitter is afterwards no longer calibrated neither regarding its measuring characteristics nor its analog outputs. The exchange has to be done as described in the following:

1. Switch off the power supply.
2. Open the terminal compartment and unplug the 6-pole connector.
3. Open the front cover and remove the decoration foil by loosening the three mounting screws and if necessary the display board inside the electronic compartment by loosening the three thread bolts.
4. Unplug the green connector on the power supply board
5. Screw out the 3 thread bolts and after that extract the power supply board carefully.
6. Disconnect the sensor's wires on the main board. Please memorize the correct order of the wires.
7. Screw out the 3 thread bolts and extract the main board carefully – please take special care of the flatcable leading to the terminal compartment.
9. The data memory chip (DSM) has to be changed over to the new electronic stack (see also chapter „data memory chip (DSM)“ on page 5).
10. Insert the new main board and feed the flatcable through the hole in the compartment partitions wall.
11. Assemble the transmitter reverse to items 1 to 7 of this list.
12. Before powering on, check all connectors to be plugged in correctly and all wires and devices are fixed.

After the exchange the transmitter is calibrated by the take-over of the data memory chip (DSM) for the sensor. All totalized counts and settings are taken on.

## mag-flux M1 control unit (Option)

### Introduction

The transmitter *mag-flux M1* can be operated depending on configuration by using a control unit or via a HART® interface.

Below the operation and parameterization of the transmitter is described using the control unit. It is located in the electronic compartment and covered by an inspection window.

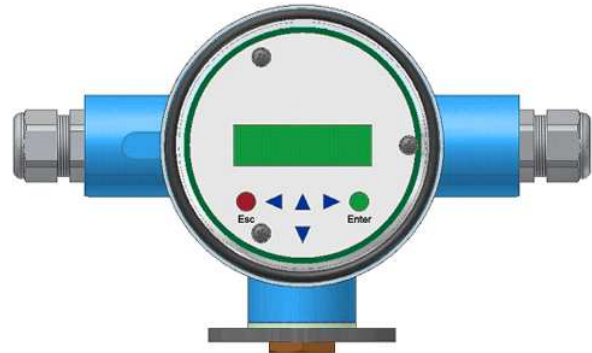


Fig 22 Transmitter *mag-flux M1* with control unit (optional)


### Display

The control unit in the *mag-flux M1* has an integrated back lighted, alphanumeric display with two 16-character lines (format 16 x 60 mm). Measurement data and settings can be read directly from this display.

The LCD display is designed to be operated at temperatures ranging from  $-20\text{ °C}$  to  $+60\text{ °C}$  ( $-4\text{ °F}$  to  $140\text{ °F}$ ) without being damaged. However, near-freezing temperatures the display becomes slow and the readability of the measured values is reduced. At temperatures below  $-10\text{ °C}$  ( $14\text{ °F}$ ), only static values (parameter settings) can be displayed. At temperatures exceeding  $60\text{ °C}$  ( $140\text{ °F}$ ), contrast decreases substantially on the LCD and the liquid crystals can dry out.

### Keys and their functions

On the control unit are six keys to change the settings.



**Caution**  
Do not press these keys with sharp or sharp-edged objects such as pencils or screwdrivers!

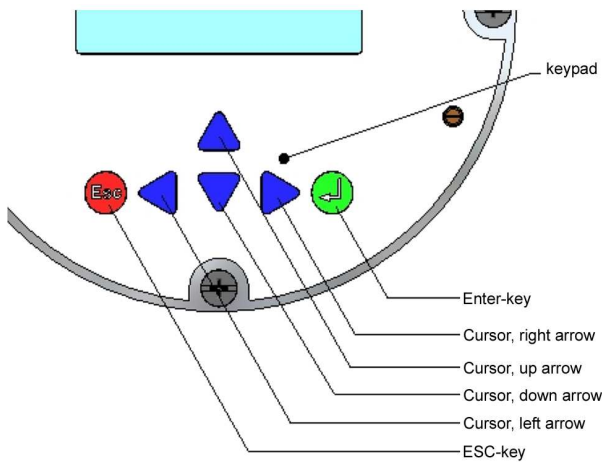
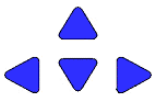


Fig 23 Keypad of the *mag-flux M1* (optional)

Cursor keys: These keys are used for:



- change numerical values
- give YES/NO answers
- select parameters

Each key is assigned a symbol in the following table:

Description	Symbol
Cursor key, right arrow	▶
Cursor key, left arrow	◀
Cursor key, up arrow	▲
Cursor key, down arrow	▼

Enter-key: The **↵**-key is used for entering the parameter level from the menu level.



**All entries are confirmed with the ↵ key.**

ESC-key: **The Esc-key is used to cancel the current action** and leads to the next higher level. This is used for rollback.



Pressing Esc twice moves you directly to the MEASURED VALUES functional class.

### Operating modes

The transmitter *mag-flux M1* can be operated in the following modes:

#### Mode 1: Display

In display mode, measured values can be displayed in various combinations and the same applies to the *mag-flux M1* settings. Parameter settings cannot be changed in this mode.

Display mode is the standard (default) operating mode when the device is switched on.

#### Mode 2: Programming

The programming mode of the transmitter *mag-flux M1* is protected by password.

The scope of the parameters, which is permissible for the customer is alterable after entering the customer password. The complete parameter set can only be altered after entering the service password for technicians.

### Operation

#### User interface

The user interface is hierarchically structured.

At the top level you can find the **Functional classes** which are displayed as headings. It represents a kind of logical groups for values and parameters.

The second level is the **menu level** and it includes either parameters or further submenus.

The third and lowest level is the **parameter level**, which only includes parameters.

All functional classes are interlinked horizontally, while all sub-items of a functional class are interconnected vertically.

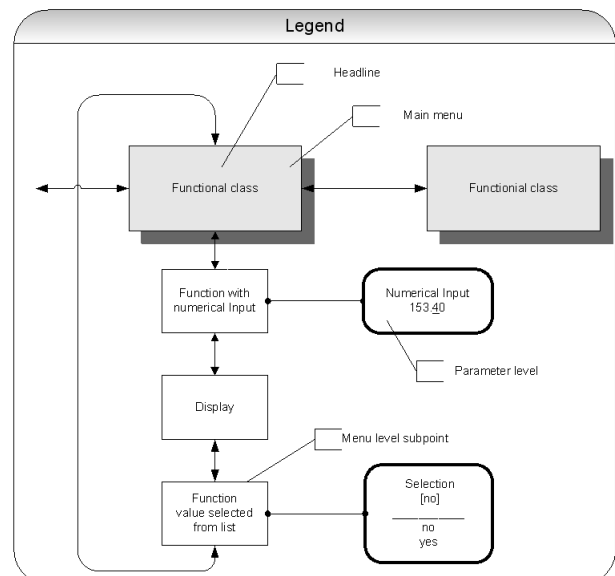


Fig 24 Structure of the *mag-flux M1* user interface

#### Functional classes, functions and parameters

Functional classes are strictly written in upper case letters (headings). For the functions and parameters at the next levels upper and lower case is used.

The various functional classes and functions are described in chapter „Transmitter functions of the mag-flux M1“ starting on page 15.

The control unit of the transmitter *mag-flux M1* has an alphanumeric display with two lines.

For the menu level always the first line of the LCD displays the corresponding heading for the menu item and the contents of second line is context-sensitive:

- information,
- YES/NO answers,
- Alternative values,
- Numerical values (with dimensions, if applicable),
- Error messages.

If the user attempts to modify values for any of these parameters without entering the required password, the message “Access denied” will be displayed (see also „**Operating modes**“ on page 13 and „**Fehler! Verweisquelle konnte nicht gefunden werden.**“ on page 14.

The various categories for submenu-items are described below..

### Selection window / make a selection

For the selection window, the first line of the LCD always displays the heading, while the second line displays the current setting. This setting is shown in square brackets if the system is in programming mode (see chapter „**Operating modes**“ on page 13).

```
Function name  
[selection]
```

In Programming mode, i.e. after a password has been entered the operator can navigate to the desired setting by using the **▲** key or the **▼** key. The actual selection will be confirmed by pressing **↵** (ENTER key). Pressing the **Esc**-key will discard changes.

### Input window / modify a value

For the input window, the first line of the LCD always shows the heading, while the second line shows the current setting.

Example:

```
Function name  
-4,567 Unit
```

These modifications can only be made in Programming mode (see chapter „**Operating modes**“ on page 13), after entering a valid password (see „**Fehler! Verweisquelle konnte nicht gefunden werden.**“ page 1). To move the cursor from one decimal place to another, use the **◀** or **▶** keys.

To in-/decrease the value of the decimal place, which is highlighted, by 1, use the **▲** or **▼** key. To change the minus and plus sign, place the cursor in front of the first digit. To confirm and apply the change, press the **↵** key.

To discard the changes, press **Esc**.

### Passwords

Programming mode is password protected.

A two level protection is implemented for the mag-flux M1.

Entering the **customer password** will allow all changes that are permissible for customers. This password can be changed when the device is first put into operation. Therefore changes should be kept in a safe place.

The factory setting for the *mag-flux M1* customer password is **0002**.

The **service password** allows modification of all functions and parameters. This password is not given to customers.

### mag-flux M1 transmitter functions

The software functions of the UMC3 transmitter are divided into functional classes, are arrayed in a circle and can be navigated by using the ◀ or ▶ cursor keys. To go back to your starting point (the MEASURED VALUES functional class) press Esc.

In the following, all software functions that can be accessed using the customer password are described. Functions that are only accessible to the vendor (service functions) are not described in this manual.

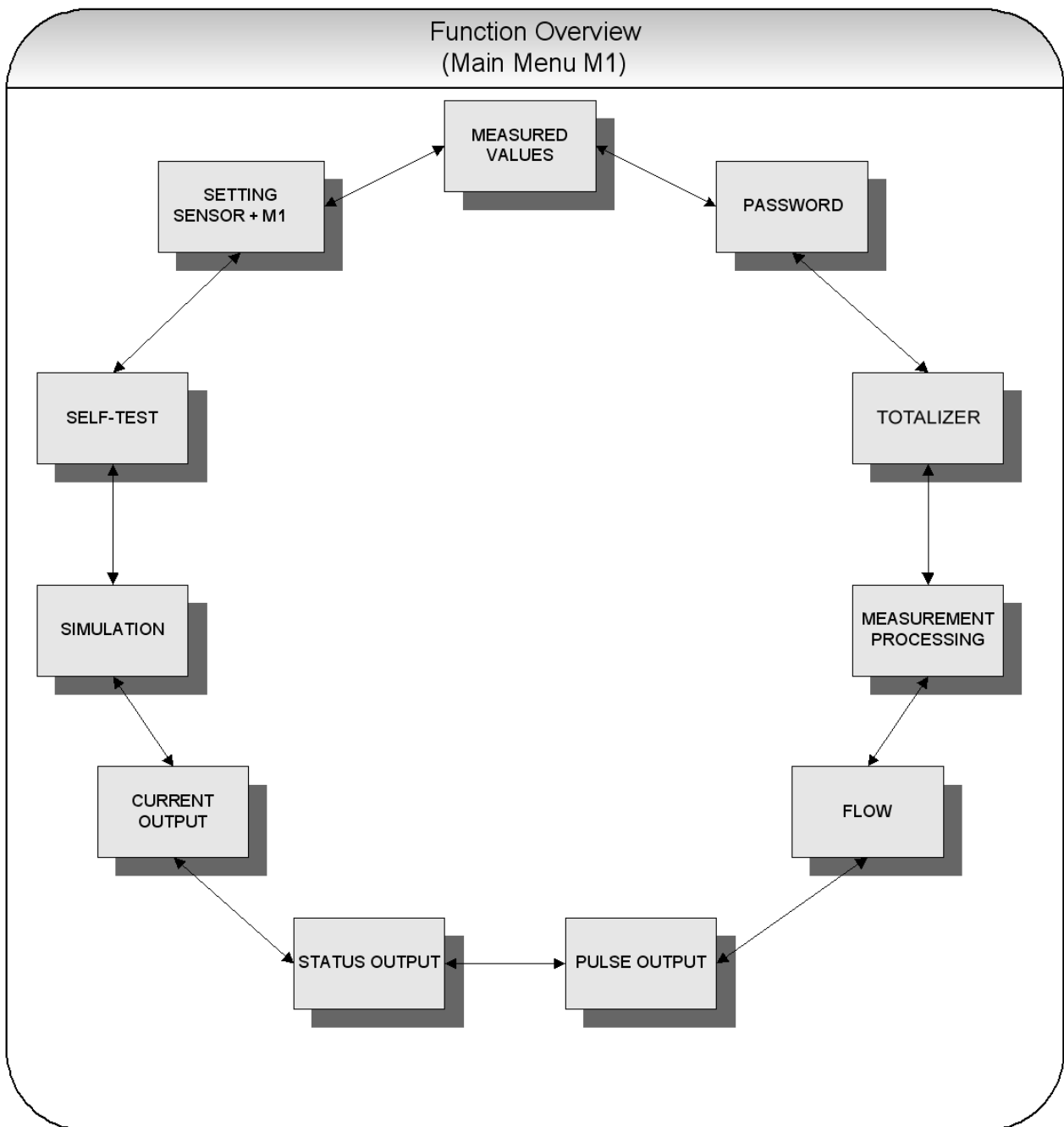


Fig 25 Main menu mag-flux M1 (functional classes)

## Functional class: MEASURED VALUES

The MEASURED VALUES functional class includes all functions for displaying the measured values.

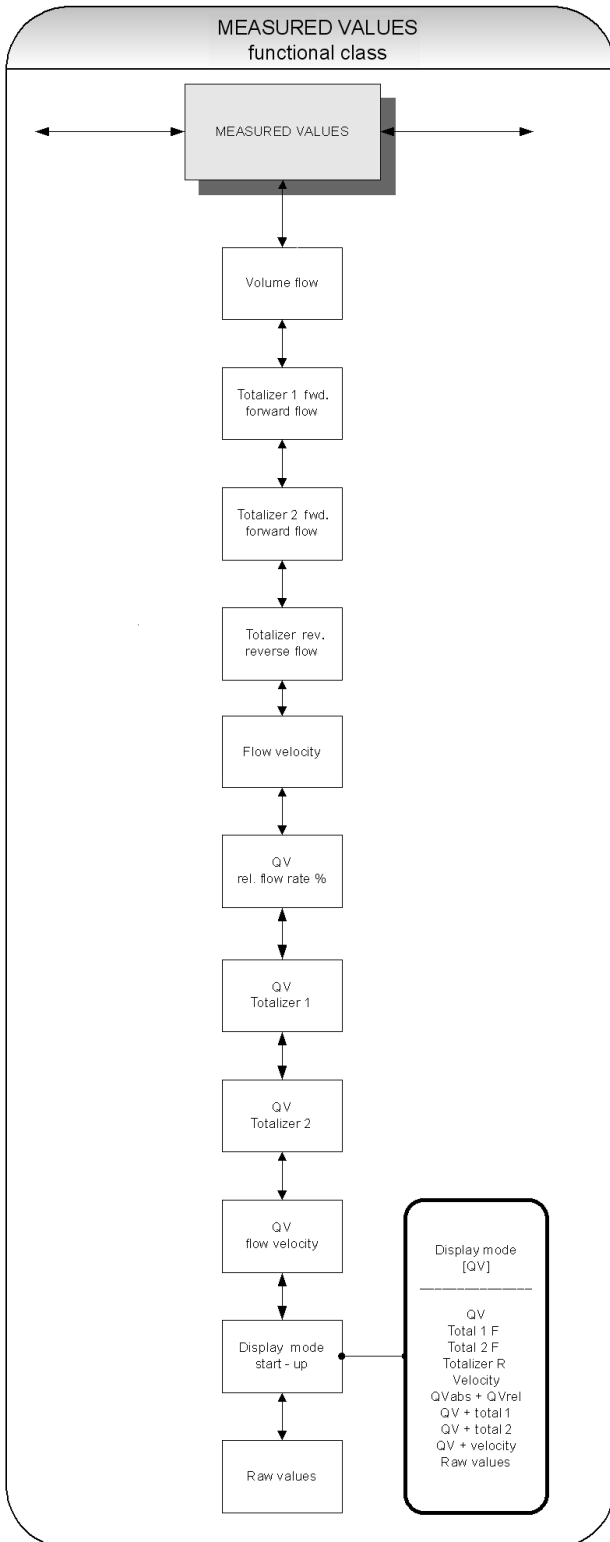


Fig 26 Funktional class MEASURED VALUES incl. all submenu items

### Volume flow rate

If you select the function `volume flow` the current value for the volume flow will be displayed:

Example:

```

    Volume flow
    100.0 l/h
    
```

The displayed unit is defined in the functional class FLOW using the function `volume flow` unit.

### Totalizer forward 1

*Totalizer forward 1* and *Totalizer forward 2* are independent totalizers that can also be reset separately. With totalizer 1, for example, you can measure the yearly or monthly volume. If you select the function `totalizer forward 1`, the following will be displayed:

Example:

```

    Totalizer 1 fwd.
    +000001.0 l
    
```

The displayed unit is defined in the functional class TOTALIZER using the function `totalizer` unit.

### Totalizer forward 2

The function is identical with totalizer 1. For example, totalizer 2 can be used as a daily counter.

If you select the function `totalizer forward 2`, the following will be displayed:

Example:

```

    Totalizer 2 fwd.
    +000001.0 l
    
```

The displayed unit is defined in the functional class TOTALIZER using the function `totalizer` unit.

### Totalizer reverse

If you select the function `totalizer reverse` the following will be displayed:

Example:

```

    Totalizer rev.
    000000.0 l
    
```

The displayed unit is defined in the functional class TOTALIZER using the function `totalizer` unit.

### Flow velocity

If you select the function `flow velocity` the LCD shows the current value of the average flow velocity of the medium.

Example:

```

    flow velocity
    1,5 m/s
    
```

The display unit is always meters per second (m/s).

The average velocity is calculated from the measured volume flow and the cross section of the meter tube. For the calculation of the cross section, the inside diameter of the meter tube is needed. It will be defined by the function `inside diameter` in the functional class `SETTINGS SENSOR + M1`.

### Relative flow rate

The relative flow rate  $Q_{rel}$  is the percentage ratio of the (current) volume flow  $Q_{abs}$  and the upper range value of the volume flow. The upper range value is defined in the functional class `FLOW` using the function `volume flow QV URV`.

The calculation of the relative flow rate is based on the following formula:

$$Q_{rel} = \frac{Q_{abs} - \text{lower range limit}}{\text{upper range limit} - \text{lower range limit}} \cdot 100\%$$

If you select the function `relative flow`, the following will be displayed.

Example:

```
Relative flow
95.3 %
```

### QV + forward totalizer 1

If the function `QV + forward totalizer 1` is selected, in the first line the value of the forward totalizer 1 and in the second line the the current value of the volume flow will be displayed.

Example:

```
XXXX.X l
T1 XXXX.XX l/h
```

The displayed unit for the volume flow is defined in the functional class `FLOW` using the function `volume flow unit` and the unit of the totalizer is defined in the functional class `TOTALIZER` using the function `totalizer unit`.

### QV + forward totalizer 2

This function is basically similar to the function `QV + forward totalizer 1`, but the only difference is, that in the first line the value of the forward totalizer 2 is displayed.

Example:

```
XXXX.X l
T2 XXXX.XX l/h
```

### QV + flow velocity

If the function `QV + flow velocity` is selected, in the first line current value of the volume flow and in the second line the the current flow velocity will be displayed.

Example:

```
XXX.X l/h
XXX.X m/s
```

The displayed volume flow unit is defined in the functional class `FLOW` using the function `volume flow unit`, the unit of the flow velocity is always `m/s`.

### Display mode during startup

By choosing the function `display mode during startup` the operator can define the default display. This selected parameter will be displayed after switching on the device and when no keystroke occurs for a long period of time.

Example:

```
Display mode
[ QV ]
```

One of the following default parameters can be selected:

- QV (volume flow rate),
- Totalizer 1 forward flow,
- Totalizer 2 forward flow,
- Totalizer 1 reverse flow,,
- Velocity,
- QVabs + QVrel,
- QV + totalizer 1,
- QV + totalizer 2,
- QV + velocity,
- and raw values.

### Raw values

The raw value display supports fault diagnostics and trouble shooting. Please inform our service department about the clear text error messages and contents of the raw value display.

Example:

```
xxx.xxx ggooo
iii gguuu
```

The displayed values are decimals and have the folling meaning:

- xxx.xxx: Is a numeric value for the measured eletrode voltage.
- iii: Is a numeric value for the current to generate the field coil's magnetic field.
- ggooo: Is a numeric value for the upper value of the reference calibration.
- gguuu: Is a numeric value for the lower value of the reference calibration.

## Functional class: PASSWORD

The PASSWORD functional class includes the functions for entering and changing the customer password and entering the service password.

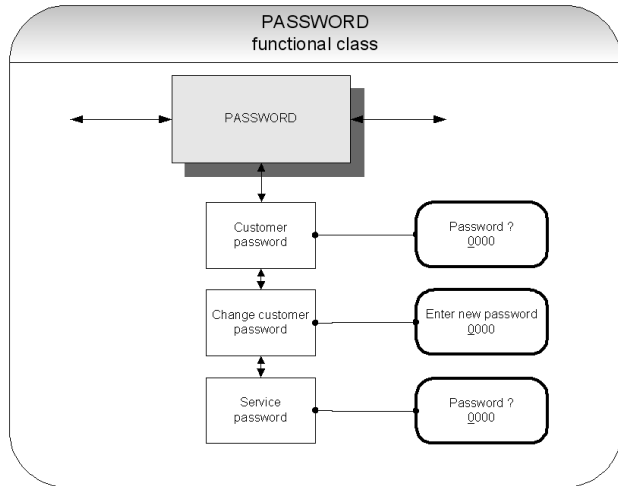


Fig 27 Functional class PASSWORD incl. all submenu items

## Customer-password

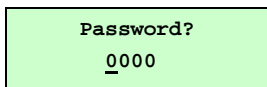
The customer password is intended to prevent changes for software parameters by the control unit without permission.

If the operator does not enter a valid password, all settings can be displayed but not changed.

**Tip**  
Parameter changes via HART® may be carried out at any time without entering password.

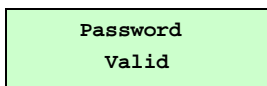
For selecting the desired function please use the key ▲ or ▼.

After selecting the `Customer password` function and pressing ↵, the following will be displayed:

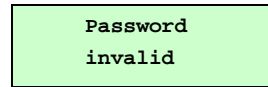


According to the description in Section „**Input window / modify a value**“, the password can be changed.

After entering a valid password, the following message will be displayed:



If the entered password is not correct, the following message will be displayed:



**Tip**  
The factory set for the customer password is **0002**.

A valid customer password allows changes for all software parameters that are permissible for customers.

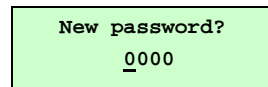
After the operator switched off the device or no keystroke occurs for about 15 minutes, the authorization for changes are canceled and the password must be entered again.

## Change customer password

After entering a valid customer password, you may change the existing password and enter a new one..

For selecting the desired function please use the key ▲ or ▼.

After selecting the function `Change customer password` and pressing ↵, the operator enters the parameter level for changing the customer password and the following will be displayed:



According to the description in Section „**Input window / modify a value**“ the changes can be done.

Press ↵ to confirm and save the new password.

**Hinweis**  
A copy of the password should be kept in a safe place. Reactivation of a transmitter at the vendor's site due to a lost password is not part of our warranty!

## Service password

The service password is not required for parameter settings which are relevant for operation.

The service password is reserved for service technicians and not provided to customers.

### Functional class: TOTALIZER

The TOTALIZER functional class includes the following functions:

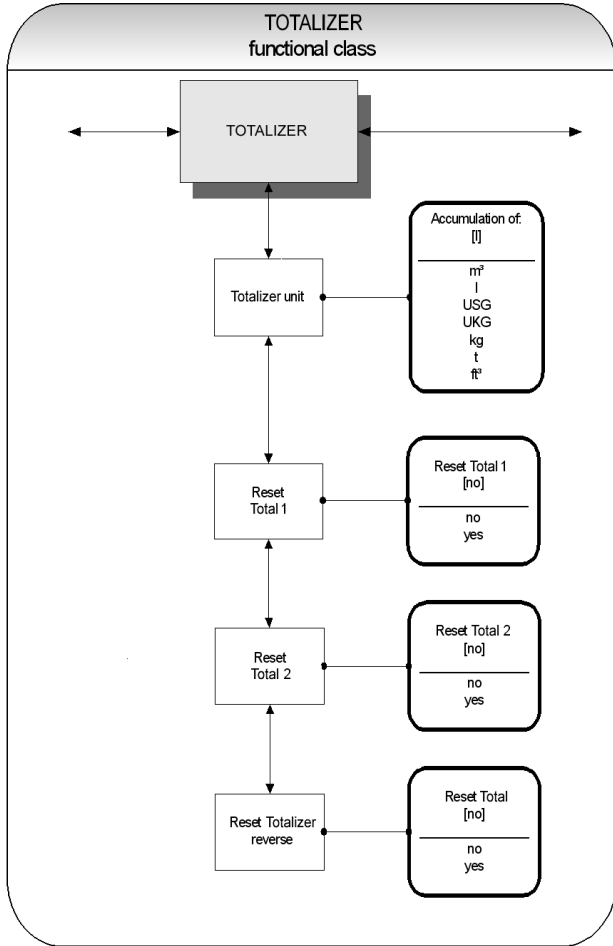


Fig 28 Functional class TOTALIZER incl. all submenu items

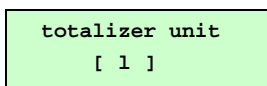
For changing the current settings and parameters the customer password is needed. Otherwise, the settings only can be watched but not be changed.

The **Esc**-key is used for discarding changes.

#### Totalizer unit

For selecting the desired function please use the key **▲** or **▼**. After choosing the function *Totalizer unit* and pressing **↓**, the current forward and reverse totalizer unit will be displayed:

Example:



How to change the parameter please refer to Section „Selection window / make a selection“.

The following units are available:

Volume units	m3	Cubic meter
	l	Liter
	USG	Gallon (US)
	UKG	Gallon (brit.)
	ft3	Cubic feet
Mass units*	kg	Kilogram
	t	Ton

**\* When selecting a mass unit the liquid density is certainly required (refer to functional class FLOW).**

The changes will be confirmed by pressing the **↓**-key and the new unit will be active as well for the forward totalizers and the reverse totalizers.

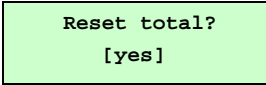
**Caution**

When the unit is changed, the totalizers will be reset to 0.00 automatically!

#### Totalizer reset

The transmitter *mag-flux M1* has three independent totalizers. Each of them can be reset individually to the initial value 0.00.

In the first step the required totalizer has to be chosen by using the **▲** or **▼** key. After the confirmation with the **↓**-key, the function *Reset totalizer* must be selected the following will be displayed:



To reset one of the totalizers, you need to toggle to **[yes]** explicitly.

By pressing **Esc** or toggling to **[no]** the current action will be aborted the menu item is quitted without changing the totalizer.

## Functional class: MEASUREMENT PROCESSING

The MEASUREMENT PROCESSING functional class includes all functions that affect the processing of the measured values.

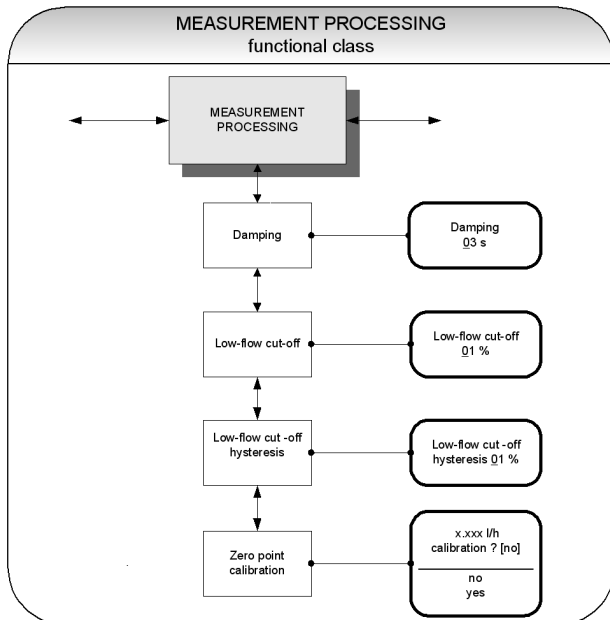


Fig 29 Functional class MEASUREMENT PROCESSING incl. all submenu-items

Before changing the current settings, the customer password has to be entered. Otherwise, the settings only can be watched but not changed.

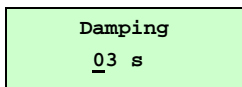
### Damping

The damping value  $\tau$  is intended to attenuate abrupt changes of the flow rate or disturbances. It affects as well the display of the measured value as the current output and pulse output of the *mag-flux M1*.

For selecting the desired function please use the key  $\blacktriangle$  or  $\blacktriangledown$ .

By choosing the function *Damping* value and pressing  $\blacktriangledown$ , the parameter level is entered and the current value for the damping is displayed:

Example:



The damping value can be varied within an interval from 1 to 60s (see also chapter „Input window / modify a value“).

**Tip**

After a jump in the measuring variable the output measured value reaches about 99% of the new setpoint after  $5\tau$ .  
The factory setting for  $\tau$  is **3** seconds.

### Low flow cut

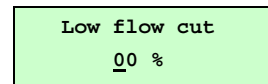
The *low flow cut* is a threshold for flow rate (percentage the upper-range value).

If the volume drops below this value (e.g. leakage), the displayed value and the current outputs will be set to "ZERO."

For selecting the desired function please use the key  $\blacktriangle$  or  $\blacktriangledown$ .

After choosing the function *Low flow cut* and pressing  $\blacktriangledown$ , the following selection field will be displayed:

Example:



The value for low flow cut can be set from 0 to 20 % in 1-percent increments.

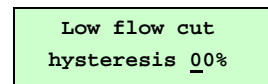
### Hysteresis for the low flow cut

The value for *hysteresis for the low flow cut* is given as a percentage of the upper-range value. It is the flow rate, the low flow cut has to be exceeded, to activate the display and the outputs of the *mag-flux M1*.

For selecting the desired function please use the key  $\blacktriangle$  or  $\blacktriangledown$ .

After selecting the function *Low flow cut hysteresis* and pressing  $\blacktriangledown$ , the following selection field will be displayed:

Example:



The *hysteresis for the low flow cut* can be set from 0 to 10 %.

### Zero point calibration

The function *Zero point calibration* is intended for recalibrating the zero point of the measuring system.

Zero point calibration is mandatory after any installation procedure or after modification of piping near the sensor. Refer also to section „zero point adjustment“ on page 11.

**Caution**

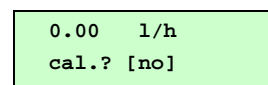
This function may only be carried out if it is certain that

- the fluid in the sensor is not flowing.  
**Otherwise, the flow rates measured subsequently will be incorrect.**
- The sensor may be completely filled with fluid. A partially filled sensor or air bubbles will lead to an incorrect zero point calibration

For selecting the desired function please use the key  $\blacktriangle$  or  $\blacktriangledown$ .

After choosing the function *Zero point calibration* and pressing  $\blacktriangledown$ , the current remaining flow rate will be displayed:

Example:



By pressing **Esc** or toggling to **[no]** the recalibration will be canceled the action will be aborted without changing the zero point.

By Toggling to **[yes]** explicitly and confirming with pressing the  $\blacktriangledown$ -key, the zero point will be recalibrated.

### Functional class: FLOW

The FLOW functional class includes functions that affect lower- and upper-range values and the processing of the measured flow rates..

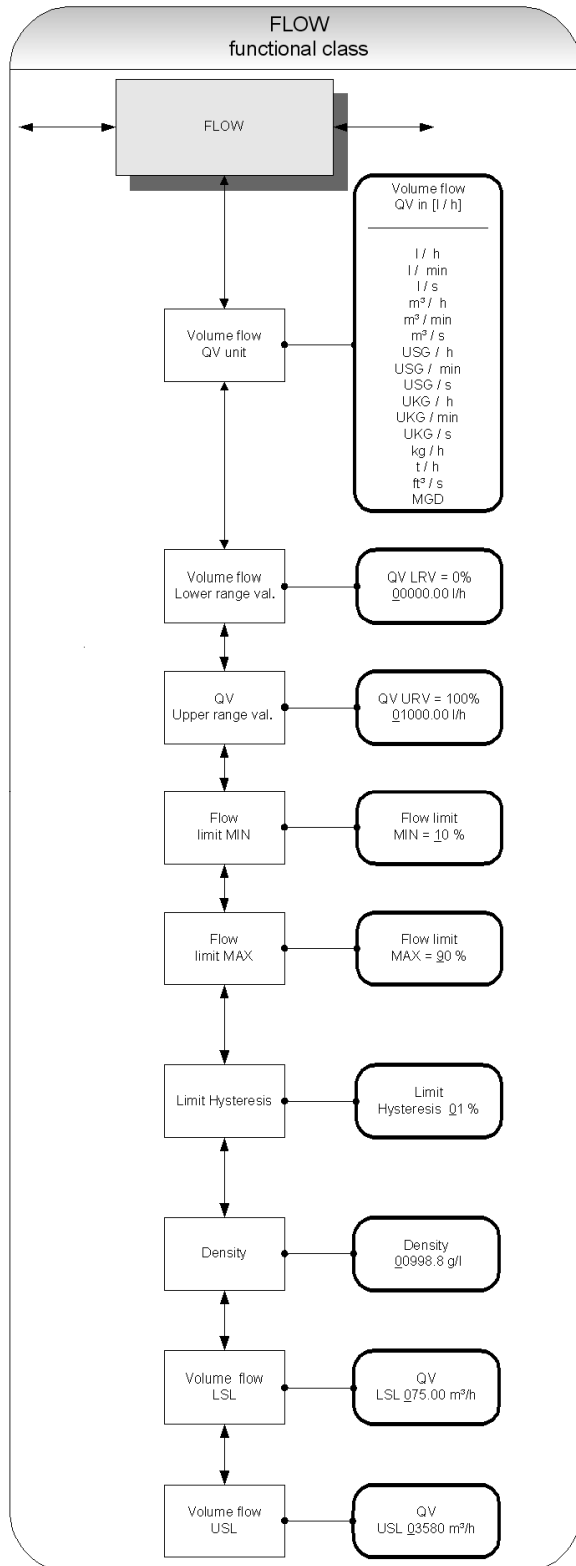


Fig 30 Functional class FLOW incl. all submenu items

Before changing the current settings, the customer password has to be entered. Otherwise, the settings only can be watched but not changed.

### Volume flow QV unit

Using this function, the physical unit, limit values and the upper-range value of volume flow can be defined.

For selecting the desired function please use the key  $\blacktriangle$  or  $\blacktriangledown$ .

After choosing the Volume flow QV unit function and pressing the  $\blacktriangle$ -key, the following selection field will be displayed:

Example:

```

    Volume flow QV
    in [ l/h ]
  
```

For changing the parameter please refer to the description in Section „Selection window / make a selection“.

The following units are available:

Volume units:            M3 / s      m3 / min      m3 / h  
                                   l / s        l / min        l / h  
                                   USG / s     USG / min     USG / h  
                                   UKG / s     UKG / min     UKG / h  
                                   kg / h  
                                   t / h  
                                   ft³ / s  
                                   MGD (Mega US Gallons / day)

Mass units\* :            kg / h  
                                   t / h

\* When selecting a mass unit the liquid density is certainly required

### Scaling the outputs of the mag-flux M1

The measuring variable *volume flow rate* is shown by the transmitter *mag-flux M1* as well as an analog current output as a pulse output.

The correlation of output and flow rate is not fixed but it can be defined by the parameters QV LRV and QV URV (see Fig 31).

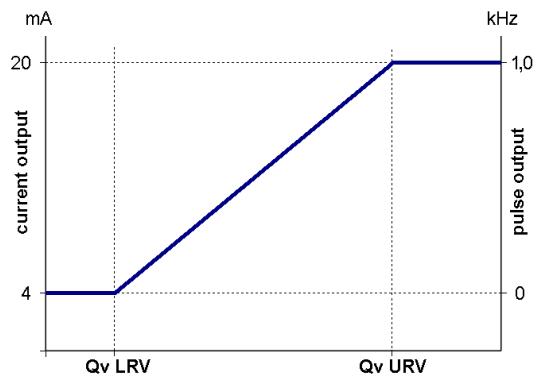


Fig 31 Output scaling of the mag-flux M1

### Volume flow lower-range value (QV LRV)

This function allows to set the lower-range value for volume flow QV LRV which corresponds to the lower-range value for the output value.

For selecting the desired function please use the key  $\blacktriangle$  or  $\blacktriangledown$ .

After choosing the function Volume flow lower-range value and pressing  $\blacktriangle$ , the following selection field will be displayed:

Example:

```

    QV LRV = 0%
    +_0.000000 l/h
  
```

## Transmitter mag-flux M1

The unit for the  $QV$  LRV is defined by the function *Volume flow unit*.

Usually the value for  $QV$  LRV is set to 0.0 (factory default).

### Volume flow upper-range value (QV URV)

This function is intended to set the upper-range value for volume flow  $QV$  URV which corresponds to the upper-range value for the output value.

After choosing the function *Volume flow upper-range value* and pressing the  $\downarrow$ -key, the following selection field will be displayed:

Example:

```
QV URV = 100%
+01000.00 l/h
```

The unit for the  $QV$  URV is defined by the function *Volume flow unit*.

### Limit value messages of the mag-flux M1

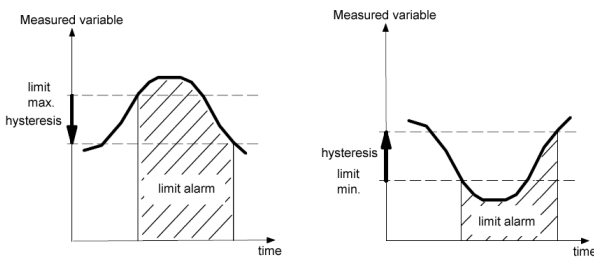


Fig 32 Limit value message and hysteresis

### Volume flow limit MIN

The MIN limit value for volume flow can be shown by the status output of the *mag-flux M1*.

The value for volume flow limit MIN is a percentage of the current measuring range (lower-range value  $QV$  LRV to upper-range value  $QV$  URV).

If the volume flow falls below that limit, the status output will be set and the current output will change to alarm value, if the alarm functions have been enabled (see also Fig 32).

The settings for the alarm state of the current output are made using function *Current output alarm* in the functional class CURRENT OUTPUT.

For selecting the desired function please use the key  $\uparrow$  or  $\downarrow$ .

After choosing the function *Volume flow limit MIN* and pressing  $\downarrow$ , the following selection field will be displayed

Example:

```
Flow limit
MIN = 10 %
```

The flow limit MIN can be set in 1-percent increments.

### Volume flow limit MAX

The MAX limit value for volume flow can also be shown by the status output of the *mag-flux M1*.

The value for volume flow limit MAX is a percentage of the current upper-range value  $QV$  URV. If the volume flow surpasses this limit, the status output will be set and the current output will change to alarm value, if the alarm functions have been enabled (see also Fig 32).

For selecting the desired function please use the key  $\uparrow$  or  $\downarrow$ .

After choosing the function *Volume flow limit MAX* and pressing  $\downarrow$ , the following selection field will be displayed:

Example:

```
Flow limit
MAX = 90 %
```

The flow limit MAX can be set in 1-percent increments.

### QV limit hysteresis

The value for  $Qv$  limit hysteresis is a percentage of the current upper-range value  $QV$  URV.

It specifies the difference between the flow rate and the set volume flow limits which is needed to reactivate respectively deactivate the limit alarm.

For selecting the desired function please use the key  $\uparrow$  or  $\downarrow$ .

After choosing the function *QV limit hysteresis* and pressing the  $\downarrow$ -key, the following selection field will be displayed

Example:

```
Qv limit
hysteresis 00 %
```

The hysteresis of the  $QV$  limiting values can be set in 1-percent increments from 0 to 10 %.

### Density

If a mass unit in kg or t is used as flow unit (see chapter „Volume flow  $QV$  unit“), the density of the medium must be entered in [g/l]. The mass flow will be calculated from the volume flow measurement using the density.

After choosing the function *Density* and pressing  $\downarrow$ , the current density value will be displayed:

Example:

```
Density
0998.2 g/l
```

According to the description in Section „Input winow / modify a value“, the current value can be changed.



#### Caution

The density is not measured. It is a parameter.

### Volume flow LSL (read only)

This value represents the minimum lower range value based on the inside diameter of the sensor. This value is normally set for a flow velocity of 0.25 m/s.

Example:

```
QV LSL
+0075.000 m3/h
```

### Volume flow USL (information field)

This value represents the maximum upper range value based on the inside diameter of the sensor. This value is normally set for a flow velocity of 11 m/s.

Example:

```
QV USL
+003580.0 m3/h
```

### Functional class: PULSE OUTPUT

The PULSE OUTPUT functional class includes the functions regarding the pulse output.

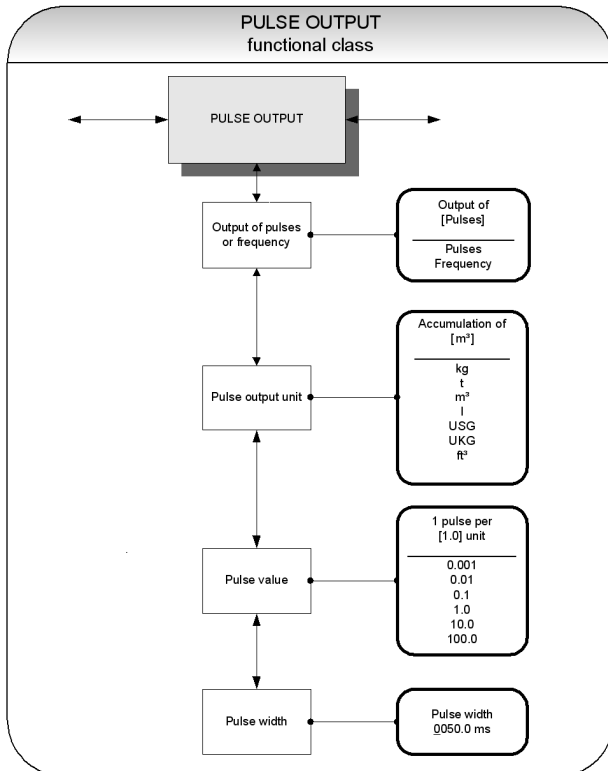


Fig 33 Functional class PULSE OUTPUT incl. all submenu items

### Pulse or frequency output

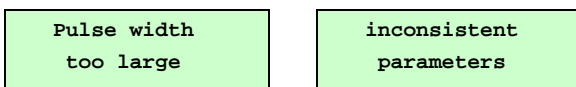
The function *Pulse or frequency output* is used to define the mode for the digital output – either pulses per flow unit or a frequency 0 to 1 kHz corresponding to the measuring range.

When selecting „**frequency**“, the maximum frequency of 1 kHz will be output when the upper-range value for mass or volume flow  $QV$  URV is reached (depending on the selected pulse unit).

If the flow rate falls below the volume flow limit MIN, the frequency is set to 0 Hz.

When selecting „**pulses**“, pulses per flow unit will be output by the transmitter. The pulse shape is defined by the parameters *pulse output unit*, *pulse value* and *pulse width*.

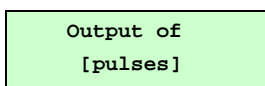
When choosing an improper combination of these parameters (e.g. the number of pulses per time unit cannot be generated due to the pulse width which is too large), one of the following error messages will be displayed.



For selecting the desired function please use the key  $\blacktriangle$  or  $\blacktriangledown$ .

After choosing the function output of pulses or frequency and pressing  $\blacktriangledown$ , the following selection field will be displayed

Example:



The factory setting for this parameter is „output of pulses“.

### Pulse output unit

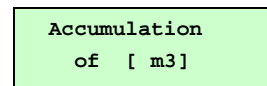
The parameter *pulse output unit* is of relevance only, if the parameter output of pulses or frequency is set to „pulses“.

This function is used to define the unit to be accumulated.

After selecting the function *Pulse output unit*, press  $\blacktriangledown$  to enter the parameter level.

The following selection field will be displayed:

Example:



For this parameter the following units are available:

Volume units:	m3	cubic meter
	l	liter
	USG	gallon (US)
	UKG	gallon (brit.)
	ft3	cubic feet
Mass units:	kg	kilogramm
	t	ton

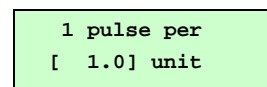
### Pulse value

The parameter *pulse value* is of relevance only, if the parameter output of pulses or frequency is set to „pulses“.

This function is used to define how many pulses will be output per accumulated unit.

After selecting the function *Pulse value*, press the  $\blacktriangledown$ -key to display the current unit:

Example:



The following values are available:

**0.001, 0.01, 0.1, 1.0, 10.0, 100.0**

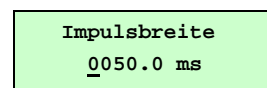
### Pulse width

This function is intended to change the width of the pulses.

For selecting the desired function please use the key  $\blacktriangle$  or  $\blacktriangledown$ .

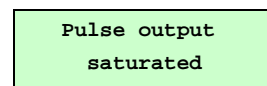
After selecting the function *Pulse width*, press  $\blacktriangledown$  to display the actual setting for this parameter:

Example:



As mentioned in Section „Input window / modify a value“ the parameter *pulse width* can be changed.

If the pulse width is too large for the current pulse rate, it will be reduced automatically and the following warning will be displayed.



The maximum output frequency  $f$  can be calculated by

$$f = \frac{1}{2 \cdot \text{pulse width [ms]}} \leq 1000\text{Hz}$$



### Tip

For connection of electronical counters, we recommend a pulse width greater than 4 ms; for electromechanical counters the value should be 50 ms.

## Functional class: STATUS OUTPUT

The functional class STATUS OUTPUT includes the functions for setting the status output.

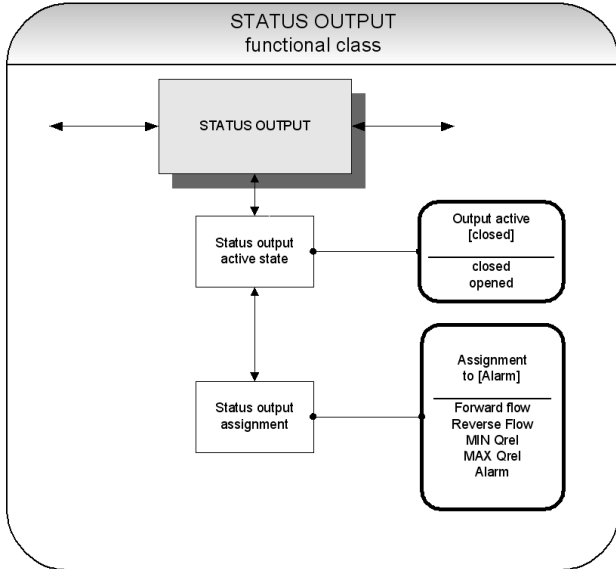


Fig 34 Functional class STATUS OUTPUT incl. All submenu items

### Status output active state

The function `Status output state active state` is intended to define the behavior of the status output.

The status output is comparable to an electrical relay that can be configured as make or break contact.

For safety-relevant applications, the setting **break contact** is highly recommended so that a power failure or failure of the electronics can be detected as an alarm.

In standard applications, the setting **make contact** is usually used.

For selecting the desired function please use the key  $\blacktriangle$  or  $\blacktriangledown$ .

After selecting the function `Status output state active state`, press the  $\blacktriangledown$ -key to display the current setting:

Example:

Output active  
[closed]

As mentioned in „Selection window / make a selection“, one of the following settings can be chosen.

Setting	Function
closed	Status output operates like <b>break contact</b> .
opened	Status output operates like <b>make contact</b> .

### Status output assignment

This function allows the operator to define the event assignment for the status output. The most common setting is the reverse flow assignment.

For selecting the desired function please use the key  $\blacktriangle$  or  $\blacktriangledown$ .

After selecting the function `Status output assignment`, press  $\blacktriangledown$  the current setting will be displayed:

Example:

Assignment  
to [Reverse flow]

As mentioned in Section „Selection window / make a selection“, one of the following settings can be chosen:

Detection of flow direction:	Forward flow Reverse flow
Limit values:	MIN Qrel MAX Qrel
All limit values and error detection:	Alarm

The default setting is forward flow.

### Functional class: CURRENT OUTPUT

The CURRENT OUTPUT functional class includes the settings for the current outputs of the transmitter.

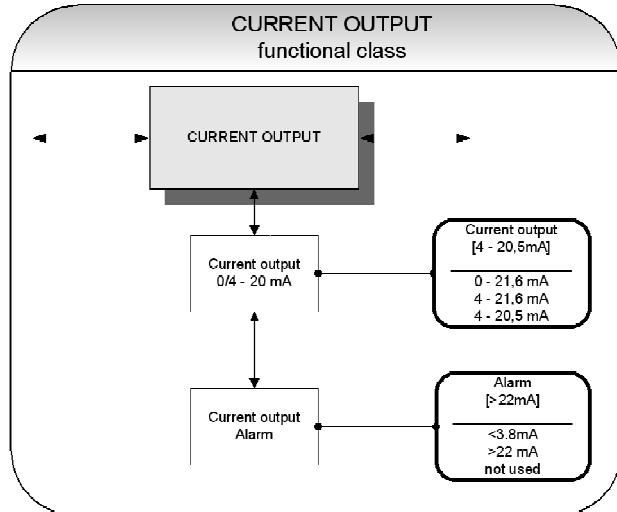


Fig 35 Functional class CURRENT OUTPUT incl. all submenu items

The current output is generally assigned to volume flow.

#### Current output 0/4 - 20 mA

This function is intended for defining the operating range for the current output.

HART® communication is not possible when selecting the range from **0 to 21.6 mA** (equal to 0 ... 110 %).

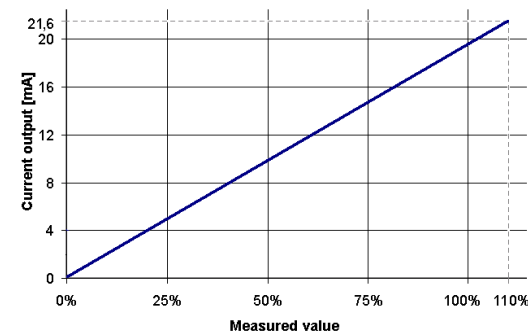


Fig 36 Current output 0 - 20 mA

The standard range from **4 to 21.6 mA** uses the measuring range up to 110 %.

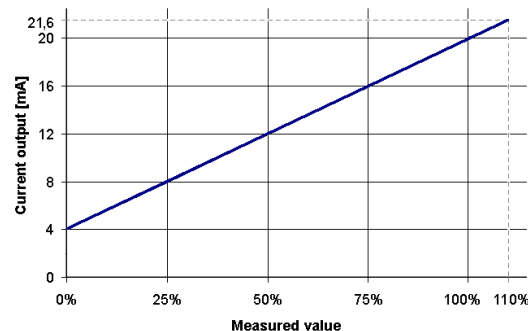


Fig 37 Current output 4-20 mA (Standard)

The range from **4 to 20,5 mA** is according to the NAMUR-recommendation and uses the measuring range up to 104%.

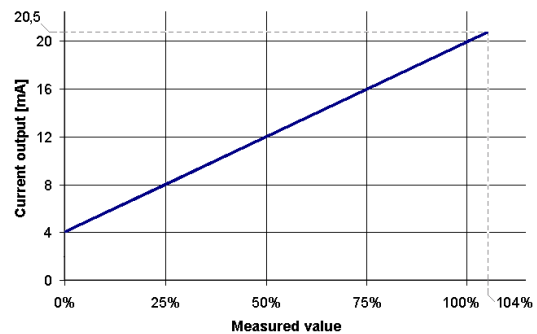


Fig 38 Current output 4-20 mA (NAMUR-recommendation)

For selecting the desired function please use the key **▲** or **▼**.

After selecting the function **Current output 0/4 - 20 mA**, press the **↓**-key to display the current setting:

Example:

**Current output**  
[ 4-21.6 ] mA

One of the following settings can be chosen (see also section „Selection window / make a selection“):

- 0 - 21.6 mA
- 4 - 21.6 mA
- 4 - 20.5 mA

#### Current output alarm

This function is intended for defining the state for the current output when an alarm state occurs. This information will be shown by the transmitter and can be analyzed e.g. in the process management system.

Press **↓** to display the current setting

Mit dieser Funktion kann festgelegt werden, welchen Zustand der Stromausgang bei der Erkennung eines Alarmzustandes annimmt. Diese Information kann im Leitsystem ausgewertet werden.

For selecting the desired function please use the key **▲** or **▼**.

After selecting the function **Current output alarm**, press the **↓**-key to display the current setting:

Example:

**Alarm**  
[ >22 mA ]

One of the following settings can be chosen (see also section „Selection window / make a selection“):

Setting	Function
not used	no alarm function
>22mA	rise of current (in the case of an alarm)
<3,8mA	reduction of current (in the case of an alarm)

## Functional class: SIMULATION

The functional class SIMULATION includes the functions for simulating output signals or output states.

If simulation mode is activated, all output signals will be generated depending on the selected items. This function enables testing of (electrical) peripherals connected to the device without water flow.

Simulation mode will be deactivated automatically if no keystroke occurs for about 10 minutes. Simulation mode can also be activated and controlled via HART® commands.

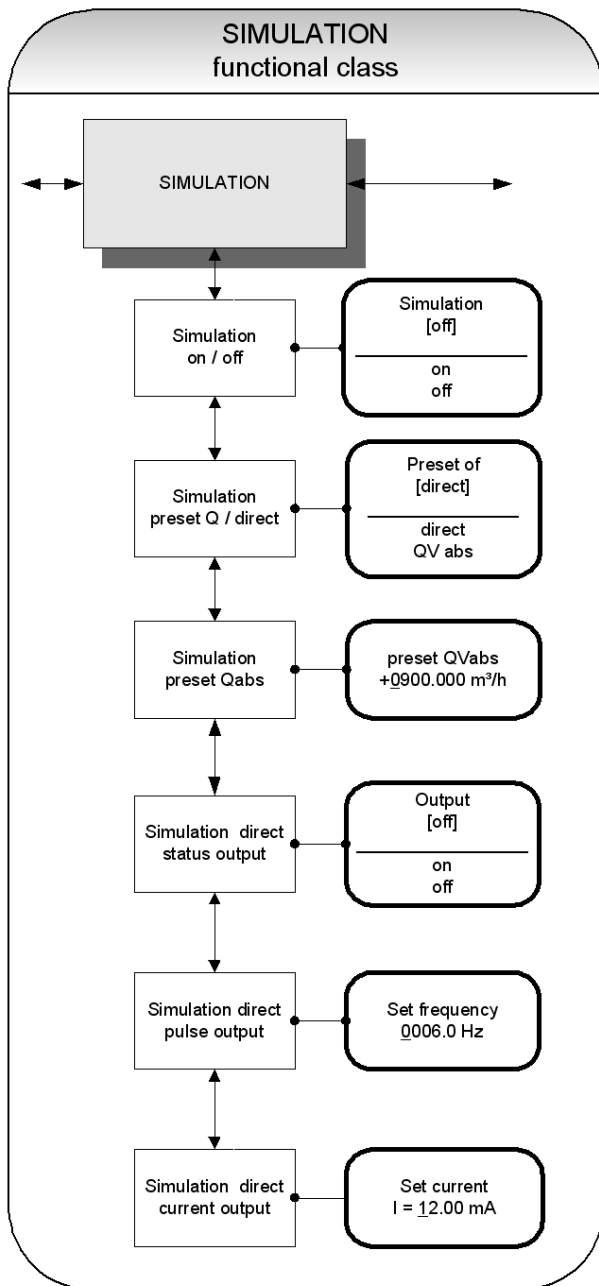


Fig 39 Functional class SIMULATION incl. all submenu items

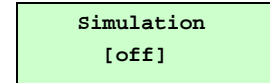
### Simulation on / off

The function *Simulation on/off* is intended for activating or deactivating simulation mode.

For selecting the desired function please use the key  $\blacktriangle$  or  $\blacktriangledown$ .

After selecting the function *simulation on/off*, press the  $\blackleftarrow$ -key to display the current setting:

Example:



For changing the parameter please refer to the description in Section „Selection windows / make a selection“.



### Tip

Simulation will be deactivated automatically after restarting the device or without a keystroke for at least 10 minutes.

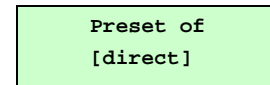
### Simulation direct / preset value Q

This function is intended for defining whether a volume flow rate  $Q_{V\ abs}$  is preset or the outputs will be set directly.

For selecting the desired function please use the key  $\blacktriangle$  or  $\blacktriangledown$ .

Press  $\blackleftarrow$ -key to display the current selection for the type of simulation:

Example:



One of the following settings can be chosen (see also section „Selection window / make a selection“):

Setting	Function
direct	Status-, pulse-, und current output* will be set directly * It is useful to make the presets for the output before starting simulation mode, using menu items <i>Simulation status output</i> , <i>Simulation pulse output</i> and <i>Simulation current output</i> . In this manner the settings can be modified specifically. <b>All outputs will be simulated simultaneously!</b>
QVabs	The measuring variable will be set.

### Simulation preset Qabs

This parameter is of relevance only, if the parameter `preset` of is set to „QVabs“.

Using this function a „measuring variable“ is preset for simulating a flow rate. Flow rates for both directions will be supported. The outputs will be affected by the simulated value for the measured value indirectly.

For selecting the desired function please use the key  $\uparrow$  or  $\downarrow$ .

After selecting the function `Simulation preset Qabs`, press the  $\downarrow$ -key to enter the parameter level for putting in the requested value:

Example:

```

preset QVabs
+00900.00 1/h
    
```

The simulation value is entered as described in Section „Selection windows / make a selection“.

### Direct simulation of outputs – status output

This parameter is of relevance only, if the parameter `preset` of is set to „direct“.

Using the function `Simulation direct status output` the status output can be affected directly.

For selecting the desired function please use the key  $\uparrow$  or  $\downarrow$ .

After selecting the function `Simulation direct status output`, press the  $\downarrow$ -key. The current setting will be displayed:

Example:

```

Status output
[off]
    
```

For changing the parameter please refer to the description in Section „Selection windows / make a selection“.

### Direct simulation of outputs – pulse output

This parameter is of relevance only, if the parameter `preset` of is set to „direct“.

Using the function `Simulation direct pulse output` the requested frequency for the pulse output can be defined.

For selecting the desired function please use the key  $\uparrow$  or  $\downarrow$ .

After selecting the function `Simulation direct pulse output`, press the  $\downarrow$ -key. The current value for the frequency will be displayed:

Example:

```

Set frequency
0210 Hz
    
```

The frequency can be set within bounds of **6 Hz to 1100 Hz**.

For changing the parameter please refer to the description in Section „Selection windows / make a selection“.

### Direct simulation of outputs – current output

This parameter is of relevance only, if the parameter `preset` of is set to „direct“.

Using the function `Simulation direct current output` the requested value for the current output can be defined.

For selecting the desired function please use the key  $\uparrow$  or  $\downarrow$ .

After selecting the function `Simulation direct current output`, press the  $\downarrow$ -key.

The actual value for the current will be displayed:

Example:

```

Set current
I = 12.50 mA
    
```

The current can be set within bounds of **0 to 23 mA**.

For changing the parameter please refer to the description in Section „Selection windows / make a selection“.

## Functional class: SELF-TEST

The function class SELF-TEST includes all functions relating to the self-test of the sensor.  
The diagnostic functions of the transmitter, which monitor the proper functioning of the electronics and the software, are always active and cannot be switched off.

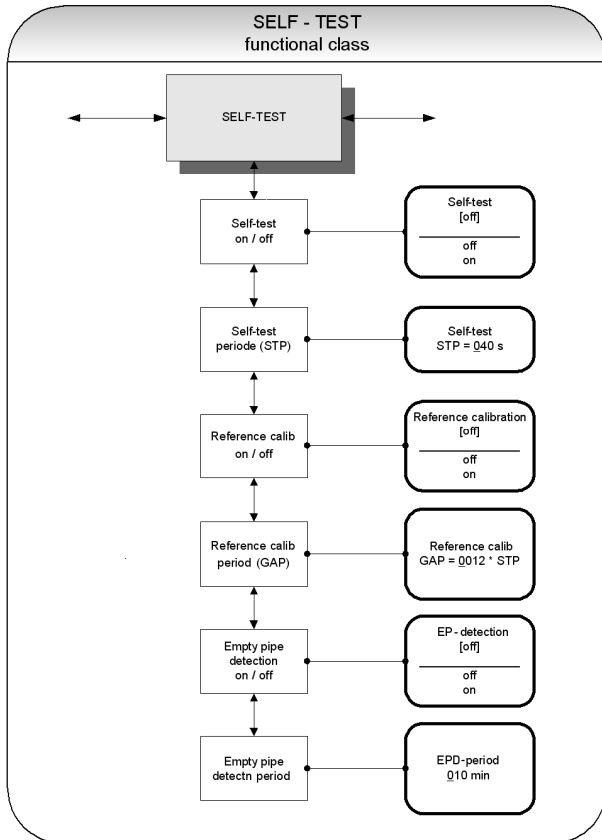


Fig 40 Functional class SELF-TEST incl. all submenu items

### Self-test on / off

The *Self-test on/off* function is intended for enabling or disabling the monitoring function of the field coil current. This function is useful for suppressing temperature dependencies of the transmitter.

After selecting the function *Self-test on/off* using the key  $\blacktriangle$  or  $\blacktriangledown$  press the  $\blacktriangledown$ -key. The current setting will be displayed:

Example:

```

Self-Test
[off]
    
```

The default setting for the monitoring function for the field coil current is „on“.

**Caution**

During the sampling time for the field coil current of 0.5 seconds, the transmitter is offline; the last measured value will be shown at the signal outputs

### Self-test period (STP)

This parameter is of relevance only, if the parameter *Self-test* is set to „on“.

Using this function the time gap for the periodical measurement of the field coil current is defined.

It can be set within bounds of **35 to 999 s**.

After selecting the function *Self-test periode (STP)* using the key  $\blacktriangle$  or  $\blacktriangledown$ , press the  $\blacktriangledown$ -key for entering the parameter level.

The current setting for the STP will be displayed:

Example:

```

Self-test
STP = 040 s
    
```

For changing the parameter please refer to the description in Section „Selection windows / make a selection“.

### Reference calibration on / off

The function *Reference calibration on/off* is used to enable or disable the periodical recalibration of the transmitter. This function is useful to maintain the long-term stability of the transmitter.

During the automatic reference calibration of 30 seconds, the transmitter is offline; the last measured value will be shown at the signal outputs.

After choosing the function *Reference calibration on/off* by the use of key  $\blacktriangle$  or  $\blacktriangledown$  and pressing  $\blacktriangledown$ , the following selection field will be displayed:

Example:

```

Reference calib.
[off]
    
```

For changing the parameter please refer to the description in Section „Selection windows / make a selection“.

### Reference calibration period (GAP)

This function *Reference calibration period* is used to define after how many STP's the reference calibration will be performed.

**Example:** The Self-Test periode (STP) is set to 40 seconds and the reference calibration should be performed every 6 hours. Therefore you have to enter for the GAP:

$$\text{GAP} = \frac{6 \cdot 3600\text{s}}{40\text{s}} = 5400$$

$\swarrow$  1 hour = 3600 s  
 $\nwarrow$  Self-Test period STP

After selecting the function *Reference calibration period (GAP)* using the key  $\blacktriangle$  or  $\blacktriangledown$  press the  $\blacktriangledown$ -key. The current setting for this parameter will be displayed:

Example:

```

Reference calib.
GAP=05400* STP
    
```

For changing the parameter please refer to the description in section „Selection windows / make a selection“.

### Empty pipe detection on / off

The function `Empty pipe detection on / off`, is used for enabling or disabling the continuous empty pipe detection.

After selecting this function by the use of key `▲` or `▼` and pressing `↵`, the following selection field will be displayed:

Example:

```
EP detection
[on]
```

The default setting for this parameter is „on“.

For further information how to change the parameter please refer to the description in section „Selection windows / make a selection“.

### Empty pipe detection period

The function `Empty pipe detection period`, is intended for defining the period of time after which the empty pipe detection will be carried.

After choosing this function using the key `▲` or `▼` and pressing `↵`, the following selection field will be displayed:

Example:

```
EPD-period
10 Min
```

For changing the parameter please refer to the description in Section „Selection windows / make a selection“.



#### Tip

When entering **00 Min** for this parameter, the detection will be performed continuously.

## Functional class: SETTINGS SENSOR + M1

This functional class SETTINGS SENSOR + M1 includes the general settings for the transmitter *mag-flux M1*.

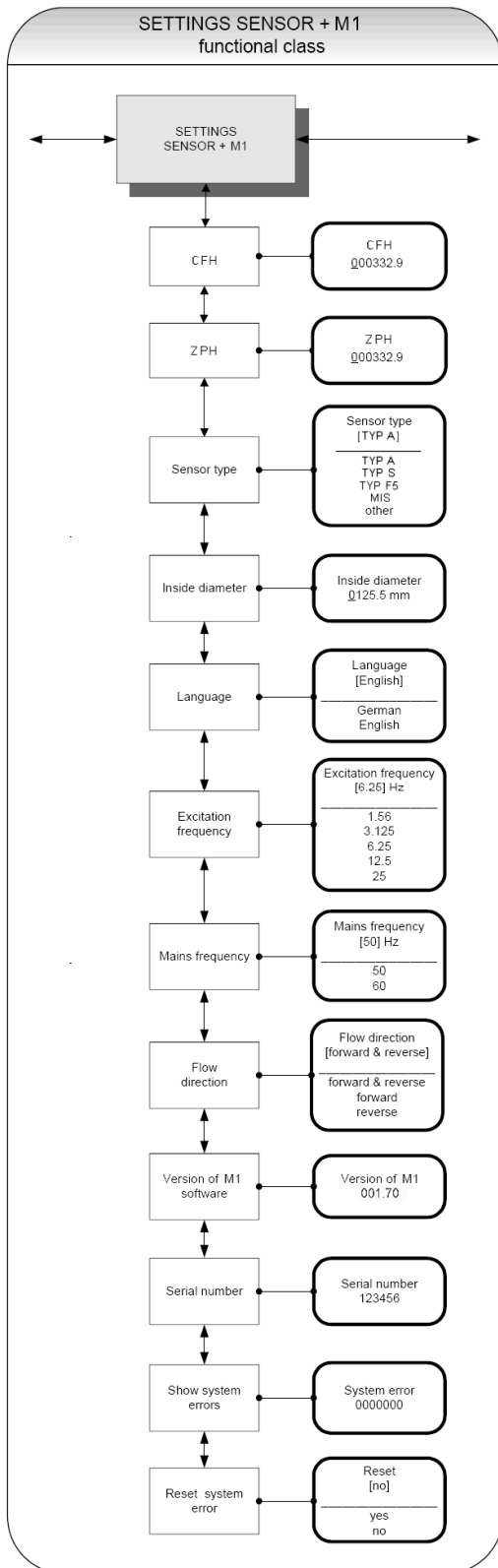


Bild 41 Functional class SETTINGS SENSOR + M1

## Sensor constant CFH

The *sensor constant CFH* is determined by calibration and it's a characteristic value for the sensor.

The value for CFH must be entered to ensure a correct measurement. It will be found on the rating plate of the sensor. After selecting the function *Sensor constant* function using the key  $\blacktriangle$  or  $\blacktriangledown$  and pressing  $\blacktriangledown$ , the parameter level will be entered and the actual value for *sensor constant CFH* will be displayed:

Example:

```
CFH
000332.90
```

For changing the parameter please refer to the description in Section „Selection windows / make a selection“.



### Caution

Changing the sensor constant CFH to a value that differs from the value on the rating plate of the sensor will result in measuring errors!



### Note

The Sensor constant is a signed value. The default setting is generally positiv.

## Sensor type

The *ZPH*-Value is determined by calibration and it's a characteristic value for the sensor. The value for ZPH must be entered to ensure a correct measurement. It will be found on the rating plate of the sensor.

Example:

```
ZPH
000002.00
```

## Sensor type

The function *Sensor type* is intended for defining the type of sensor with is connected to the transmitter. The distinction of the sensor type is necessary and essential because the algorithm for flow rate calculation differs from sensor type to sensor type. After selecting this function using the key  $\blacktriangle$  or  $\blacktriangledown$  and pressing  $\blacktriangledown$ , the current setting will be displayed:

Example:

```
Sensor type
[ TYP A ]
```

Usually this parameter is factory-set and it has to be changed even when the transmitter is used with a different type of sensor.

## Inside diameter

The inside diameter of the connected sensor is needed for calculating the mean flow velocity. To ensure a correct measurement the diameter must be specified exactly.

After choosing the function *inside diameter* using the key  $\blacktriangle$  or  $\blacktriangledown$  and pressing  $\blacktriangledown$ , the following selection field will be displayed:

Example:

```
Inside diameter
0050 mm
```

For changing the parameter please refer to the description in Section „Selection windows / make a selection“.

### Language

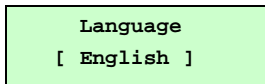
When using the control unit, different languages are available for the user guidance of the *mag-flux M1*.

The function *Language* is intended for setting the language.

The settings **English** and **German** are available.

After choosing the desired function using the key  $\blacktriangle$  or  $\blacktriangledown$  and pressing  $\blacktriangleright$ , the following selection field will be displayed:

Example:



For changing the parameter please refer to the description in Section „Selection windows / make a selection“.

### Excitation frequency

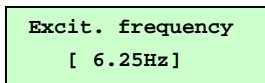
The function *Excitation frequency* is intended for setting the excitation frequency of the field coil current.

Because of the inductance of the field coils the maximum frequency is limited and that's why it can't be assigned freely.

The factory-set for the excitation frequency is **6.25 Hz**.

After choosing the desired function using the key  $\blacktriangle$  or  $\blacktriangledown$  and pressing  $\blacktriangleright$ , the following selection field will be displayed:

Example:



For changing the parameter please refer to the description in Section „Selection windows / make a selection“.

**Caution**  
If the excitation frequency is changed, a reference calibration (see „Reference calibration on / off“) must be accomplished! Otherwise the measuring accuracy is not ensured.

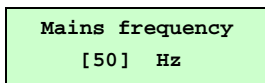
### Mains frequency

To provide the optimum interference suppression the mains frequency is needed and the the function *Mains frequency* is intended to enter this parameter.

The default setting is **50 Hz**.

After choosing the function *Mains frequency* using the key  $\blacktriangle$  or  $\blacktriangledown$  and pressing  $\blacktriangleright$ , the following selection field will be displayed:

Example:



### Flow direction

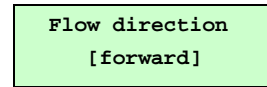
This function is intended to define the flow direction that is taken into account by the transmitter.

The standard factory setting is „**forward & reverse**“.

The setting „**forward**“ will prevent reverse flow from being measured and in analogous manner „**reverse**“ will neglect forward flow.

After selecting the function *Flow direction* using the key  $\blacktriangle$  or  $\blacktriangledown$  and pressing  $\blacktriangleright$ , the current setting will be displayed.

Example:



For this parameter the following settings are available:

- forward

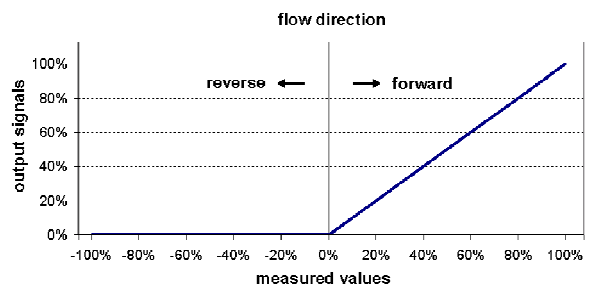


Fig 42 Output signals (setting **forward**)

- reverse

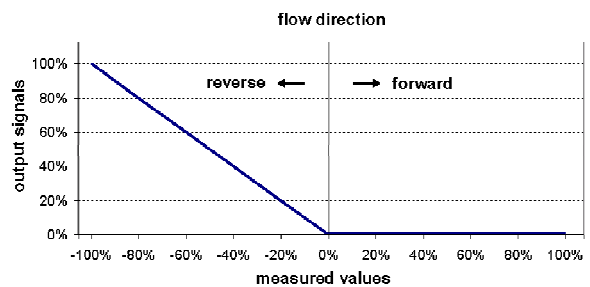


Fig 43 Output signals (setting **reverse**)

- forward & reverse

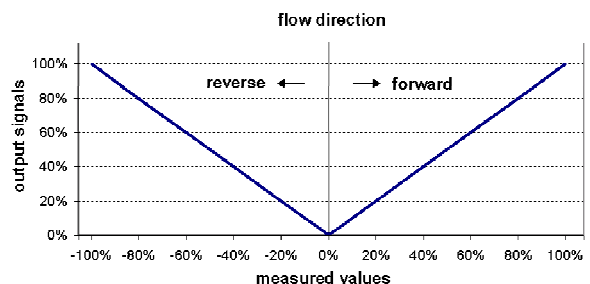


Fig 44 Output signals (setting **forward & reverse**)

## Software version (information field)

After selecting the function `Software version` the version of the transmitter software will be displayed:

After choosing the desired function using the key `▲` or `▼` and pressing `↵`, the software version will be displayed:

Example:

```
Version of M1
01.70
```

## Serial number (information field)

The parameter `Serial number` is unique and allows a reference if the device needs servicing and it's printed on the rating plate of the transmitter.

After selecting this function using the key `▲` or `▼` and pressing `↵`, the serial number will be displayed:

Example:

```
Serial number
0100683
```

## Show system errors

This function is intended to show the history of system errors that have occurred.

After selecting the function `show system errors` using key `▲` or `▼` and pressing `↵`, the code of last system error will be displayed.

Example:

```
System error
0000000
```

## Reset system error

This function is intended to reset the system error list of the *mag-flux M1*.

For further information, see Section „Reset system error“.

After fixing the error cause the corresponding system error can be reset. Therefore select the function `reset system error` using key `▲` or `▼` and pressing `↵`.

The following message will be displayed:

```
Reset ?
[ no]
```

To reset a system error, you need to toggle to **[yes]** explicitly.

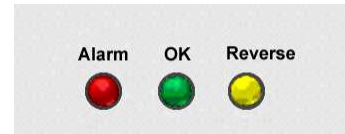
By pressing **Esc** or toggling to **[no]** the current action will be aborted the menu item is quitted without resetting.

If the message reappears shortly after, do contact our technical service department.

## Error messages

### Basic Version

In the basic version of the *mag-flux M1* the red LED acts as an error indicator.



The following modes are possible:

LED mode	Description
Off	Normal operation
On	Error / mal function
Flashing	Limit exceeded (e.g. flow rate too high)

A more detailed diagnosis is not available in the basic version.

### Enhanced version with LC-Display

The integrated diagnostic system of the transmitter *mag-flux M1* distinguishes between two types of errors (see also Section „Transmitter error messages“).

**Self-test errors** such as problems with a sensor line or inconsistent parameter settings are displayed as textual error messages on the LCD. When the cause of error has been fixed, the message disappears from the display automatically. For further information, see section „Display of self-test errors“.

Errors that indicate system memory failure, division by zero or a damage of the electronics unit are characterized as **system errors**. These error messages are not reset automatically when the error disappears.

If the cause of any error messages described below cannot be fixed, please contact the Mecon Service.

### Self-test error messages

When a **self-test error** occurs the corresponding error message is displayed as plain text in the second line of the LCD. The language is set by parameter language (please refer to chapter „SETTINGS SENSOR + M1“ on page 31.)

Display		Description	Possible cause of trouble and troubleshooting
German	English		
Rohr leer	empty pipe	Empty-pipe detection has been activated. Fluid density is too low; empty-pipe detection, pipe is empty.	Media contains air bubbles / pipe is empty. Bubble-free filling must be ensured.
Spulenstrom	exciter current?	Interruption / short circuit in the excitation coil. All signal outputs will be set to zero.	Check the wiring between transmitter and sensor.
Messkreis überst.	meas. circ. sat.	The input circuit is overloaded / the measured electrode voltage is too high. All signal outputs will be set to zero.	Flow rate exceeds the upper range value (URL). High electrostatic voltage at the electrodes.
Strom überst.	curr. saturated	The current output is overloaded. Based on the selected settings and the current assigned measured variable, the output current is > 21.6 mA.	Check the upper-range value and the flow rate settings.
IMP übersteuert	pulse out satur.	The pulse output is overloaded. The current measured value requires a pulse rate, which can not be generated with the set pulse duration and pulse value.	Check pulse duration, pulse value, and measuring range. Check the flow rate.
Parameter inkons.	params inconsist	Parameter set is inconsistent *.	Check the parameter settings. The set parameters are contradictory. Example: The combination of Upper-range value, pulse value and pulse duration has to fit for all measured values.
ext EEPROM fehlt	missing EEPROM	The data memory module (DSM) with the calibration data of the sensor and the customer-specific settings of the transmitter is missing.	Insert the data storage module (DSM) in the socket on the power supply board of the mag-flux M1.

\*

### Information:



#### Error message: "Parameter is inconsistent" (system error 0x0400)?

To recall a list of all inconsistencies, first enter a valid password and immediately an invalid password.

The control unit will show a complete list of current errors (only once). After entering the correct password, the inconsistent settings can be corrected.

## System error messages

**System errors** will be displayed starting with the message "system error" followed by a 5-digit number in hexadecimal code.

The error codes are explained in the following table:

Description	Error code	Beschreibung
System errorExtEEProm	0x00002	External EEPROM (data memory chip DSM) plugged in but is empty, not initialized
System errorIntEEProm	0x00004	Internal EEPROM (calibration M1 transmitter) erased, M1 uncalibrated
System errorEEPROM	0x00010	Failure when saving or reading of memory data / memory fault

If several errors occur at the same time, the hexadecimal sum of the individual errors will be displayed. This allows an easy identification of the single error codes.

The sums are unique..

## Standards and authorizations

### General standards and directives

- EN 60529 Ingress protection class (IP code)
- EN 61010 Safety requirements for electrical metering, control and laboratory devices
- NAMUR guideline NE21, Version 10/02/2004

### Electromagnetic compatibility

- EMC Directive 89/336/EEC
- EN 61000-6-2:1999 (immunity for industrial environments)
- EN 61000-6-3:2001 (emissions residential environments)
- EN 55011:1998+A1:1999 group 1, class B (emitted interference)
- DIN EN 61000-4-2 to DIN EN 61000-4-6
- DIN EN 61000-4-8
- DIN EN 61000-4-11
- DIN EN 61000-4-29
- DIN EN 61326

## Product Return Form

Due to legal rules and regulations, as well as for the protection of our employees and our own facilities, we require this CONTAMINATION DECLARATION to be filled out and signed, before we can process your order.

Prior to shipping the device, any media residue must be removed. This is particularly important, if the media is potentially hazardous to health or the environment. It is imperative that this completed and signed declaration is part of the shipping documentation. This also applies to additional safety data sheets and/or special requirements for handling the measuring media.

**Company details:**

Address: .....

Company: .....

Phone no.: .....

Name: .....

**Sensor information:**

Kom.Nr.: .....

Type: .....

**Media warning signs:**



poisonous



harmful to health



corrosive



radioactive



safe



explosive



in-flammable



environmental hazard

(Cross out if not applicable)

We hereby declare, that all devices returned have been cleaned, compliant with the safety regulations pertaining to hazardous materials, and that all media has been removed accordingly. No hazardous or poisonous substances remain in the device and no harm will come to either people or the environment that could be caused by residue of the measuring media.

Date: .....

Signature: .....