

Certified according to DIN ISO 9001

# Manual



## C-FLOW

Coriolis Mass Flow Meter

**SW-Version**

Main: V2.0x

Display: V2.0x

Manual-Revision: See rear cover

<b>1</b>	<b>GENERAL INFORMATION</b>	<b>6</b>
1.1	FEATURES	6
1.2	SAFETY	8
1.2.1	General Safety	8
1.2.2	Special requirements for Ex installations	8
1.2.3	Warnings in this manual	9
1.3	ORDERING CODES AND ACCESSORIES	10
1.3.1	Ordering Code	10
1.3.2	Accessories	12
1.4	MEASURING PRINCIPLE KCM	12
<b>2</b>	<b>GETTING STARTED</b>	<b>13</b>
2.1	UNPACKING	13
2.2	OPERATING ELEMENTS	14
2.2.1	KCE80xx-WG and compact version	14
2.2.2	KCE80xx-SG and KCE80xx-SE	15
2.2.3	KCMxxxx.1... (remote version)	16
2.3	PIN ASSIGNMENTS	17
2.3.1	KCE80xx-WG and compact version (standard housing, non Ex)	17
2.3.2	KCE80xx-WE and compact version (Ex)	19
2.3.3	Panel mount version KCE80xx-SG (non Ex)	21
2.3.4	Panel mount version KCE80xx-SL-* <i>-Ex</i>	23
2.4	QUICK START	25
2.4.1	First Operation	25
2.4.3	CONTROL Menu	26
2.4.4	Using the magnet	26
<b>3</b>	<b>INSTALLATION</b>	<b>27</b>
3.1	MECHANICAL	27
3.1.1	Installation Guidelines	27
3.1.2	Horizontal Installation	28
3.1.3	Vertical Installation	28
3.1.4	Installation in a Drop Line	29
3.1.5	Critical Installations	29
3.1.6	Mechanical Installation of the electronics (-W and -S version)	30
3.2	ELECTRICAL INSTALLATION	31
3.2.1	Connecting KCE and KCM	32
3.2.2	Electrical Installation of Wall Mount and Compact Version	32
3.2.3	Electrical Installation of Panel Mount Version	33
3.2.4	Power Supply and Grounding	33
3.2.5	Connecting the control inputs and outputs	36
3.2.6	Connecting the analog outputs	37
3.3	EX INSTALLATION	38
3.3.1	Locating the Compact Version	38
3.3.2	Locating the Remote Version with KCE80** <i>-WE</i> -* <i>-**</i> -Ex	38
3.3.3	Locating the Remote Version with KCE80** <i>-SE</i> -* <i>-Ex</i>	38
3.3.4	Electrical connections	38
3.3.5	Power Supply and Grounding	39
3.3.6	Digital Control Inputs and Outputs	39
3.3.7	Analog Outputs	39
<b>4</b>	<b>MANUAL OPERATION</b>	<b>40</b>
4.1	POWER ON SEQUENCE AND PRINCIPLES OF MANUAL CONTROL	40
4.1.1	Using the magnet	41
4.2	SETUP GUIDELINES	42

4.2.1	Meter Mode .....	42
4.2.2	Offset Calibration .....	42
4.2.3	Flow filter .....	42
4.2.4	Cutoff .....	43
4.2.5	Step response .....	43
4.2.6	Interaction of the parameters .....	43
4.3	MEASURING MODE .....	45
4.3.1	Function of the keys .....	45
4.3.2	Display selection .....	45
4.3.3	Resetting the batch value .....	45
4.3.4	Error Menu .....	45
4.4	OFFSET CALIBRATION .....	46
4.5	CONTROL MODE .....	47
4.5.1	Function of the keys .....	47
4.5.2	Submenus in the Main Menu .....	47
4.5.3	ZERO OFFSET Menu .....	48
4.5.4	DISPLAY Menu .....	49
4.5.5	SETUP Menu .....	55
4.5.6	SETUP PARAMETER menu .....	56
4.5.7	SETUP IN/OUTPUT menu .....	59
4.5.8	SETUP DATA CONFIGURATION menu .....	64
4.5.9	SETUP RESET TOTAL menu .....	65
4.5.10	I/O-TEST Menu .....	66
4.5.11	SERVICE Menu .....	68
<b>5</b>	<b>REMOTE OPERATION .....</b>	<b>69</b>
5.1	RS485 .....	69
5.1.1	Electrical connection of RS-485 .....	69
5.1.2	Ex installation of RS485 .....	69
5.1.3	RS485 Interface Protocol .....	69
5.2	HART .....	70
5.2.1	Electrical connection for HART .....	70
5.2.2	Ex installation for HART .....	70
5.2.3	HART Interface Protocol .....	70
5.3	FOUNDATION FIELDBUS .....	71
5.3.1	Electrical connection of Foundation Fieldbus .....	71
5.3.2	Ex installation of Foundation Fieldbus .....	71
5.3.3	FF Interface Protocol .....	71
<b>6</b>	<b>SERVICE AND MAINTENANCE .....</b>	<b>72</b>
6.1	MAINTENANCE .....	72
6.2	TROUBLE SHOOTING .....	72
6.3	CHANGING THE FUSES .....	73
6.3.1	Changing the fuse with the KCE80**-WG-*.*** and compact version .....	73
6.3.2	Changing the fuse with the KCE80**-SG-* .....	73
6.3.3	Changing the fuse with the Ex versions .....	73
6.4	CALIBRATION .....	74
6.4.2	Flow Calibration .....	78
6.5	SERVICE .....	79
6.6	RELOADING FACTORY SETTINGS .....	79
<b>7</b>	<b>LISTINGS .....</b>	<b>81</b>
7.1	WARRANTY .....	81
7.2	CERTIFICATIONS AND COMPLIANCES .....	81
7.3	TECHNICAL DATA .....	83
7.3.1	Technical Data KCM Transducer .....	83

---

7.3.2	<i>Ex Data KCM Transducer</i> .....	84
7.3.3	<i>Technical Data KCE 8000 Transmitter</i> .....	85
7.3.4	<i>Ex Data KCE Transmitter</i> .....	87
7.3.5	<i>Dimensional Drawings (mm)</i> .....	88
7.4	WEEE AND ROHS.....	93
7.5	LIST OF FIGURES.....	93
7.6	LIST OF TABLES.....	93
7.7	ADDRESSES.....	94

# 1 General Information

## 1.1 Features

The C-Flow Mass Flow Meters based on the Coriolis principle show many advantages compared to other flow meter principles:

- No moving parts
- High accuracy
- Simultaneous measuring of mass flow, density and temperature
- Calculation of volume flow as well as mass and volume total
- Flushable

The C-Flow Mass Flow Meters are available as compact version with onsite display and as meter with remote display for wall or panel mount.

All versions are available as standard version as well as Ex certified for hazardous locations.

The meters provide the following features:

- A graphic display
- Menu driven control with soft keys for easy operation also without manual
- 2 freely programmable 4-20 mA outputs
- 1 freely programmable frequency output
- 1 control input and 1 control output
- RS485 interface

As an option are available

- HART interface
- Foundation Fieldbus interface



Fig. 1: Compact version



Fig. 2: Separate versions, wall mount (left) and panel mount (right)

## **1.2 Safety**

### **1.2.1 General Safety**

All statements regarding safety of operation and technical data in this manual will only apply when the unit is operated correctly in accordance with this manual.

The data for Ingress Protection will only apply when all connectors are capped properly with the corresponding counterpart with the same or better IP rating. Cable glands must be populated with cables with the specified diameter and closed properly. The display cover must be closed.

During operation all openings of the housing must be closed unless otherwise noted in this manual.

All connections to the load and to the supply must be made with shielded cables unless otherwise noted in this manual. This unit must be grounded.

As a protection against fire in the positive supply a fuse with a current rating not higher than the current carrying capacity of the cable used is required.

Before installing the flow meter and transmitter the user is responsible to ensure that all wetted parts are compatible with the fluid or gas to be measured.

The user has to adhere to the instructions for installing electrical devices and corresponding instructions.

The devices described in this manual may only be connected and operated by authorized and qualified personnel.

### **1.2.2 Special requirements for Ex installations**

In hazardous locations the covers of the electronics of the compact or wall mount version must not be opened under any circumstances if the supply voltage is alive. For operating the keys the magnet must be used.

The analogue and digital I/O signals are not specified for driving Ex i circuits.

When using long cables make sure that the maximum inductances and capacitances for the respective voltage or gas group are not exceeded.

The maximum values specified in chapter 7.3.4 must be observed at any time.

### 1.2.3 Warnings in this manual

**NOTE:**

Notes provide important information for the correct usage of the equipment. If the notes are not observed, a malfunction of the equipment is possible.

---

**WARNING!**

Warnings provide very important information for the correct usage of the equipment. Not observing the warnings may lead to danger for the equipment and to danger for health and life of the user

---

### 1.3 Ordering Codes and Accessories

#### 1.3.1 Ordering Code

		<b>type</b>	
K C E 8 0 0 0		Electronics for KCM0300 - KCM3000	
		<b>Housing (2 digits)</b>	
W G		Wall mount housing with fixed cable to KCM	
W E		Wide wall mount housing with fixed cable to KCM	
S G		Panel mount housing	
S E		Wide panel mount housing for Ex	
		<b>Options (1 digit)</b>	
-		24V DC supply, RS485 (standard)	
B		24v DC and 100 - 240V AC supply, RS485	
H		24V DC supply, RS485, HART	
M		100 - 240V AC supply, RS485	
		<b>Cable length (WG version only, 2 digits)</b>	
L L		length of cable to KCM in meter	
		<b>Ex protection according to ATEX</b>	
-		no Ex protection	
E x		Ex protection according to ATEX	
K C E 8 0 0 0	- W G - H - 1 5 - E x		

KCE8000, wall mount housing, 24V DC supply, HART, 15m cable, Ex protected

<b>Flow range</b>	
K C M 0 3 0 0	3 - 300 kg/h
K C M 0 6 0 0	6 - 600 kg/h
K C M 1 5 0 0	15 - 1500 kg/h
K C M 3 0 0 0	30 - 3000 kg/h
<b>Electronics</b>	
0	junction box for remote electronics (KCM0600 - KCM3000)
1	junction box for remote electronics (KCM0300)
C F	compact version, 24V DC supply, RS485
CFH	compact version, 24V DC supply, RS485, HART
C M	compact version, 100 - 240V AC supply, RS485
CMH	compact version, 100 - 240V AC supply, RS485, HART
<b>Material</b>	
H D	high pressure, SS316Ti housing
<b>Rupture disk</b>	
	none
B	rupture disk
<b>Process connections</b>	
R F	BSP female thread
<b>Process connections</b>	
½ "	BSP ½"
<b>Pressure rate</b>	
P N n n n	pressure rate (nnn bar)
<b>electr. Connection</b>	
	compact version
3	Junction box
<b>Ex protection</b>	
	no Ex protection
E x	ATEX Ex i

KCM0300, 3 – 300kg/h, junction box for remote electronics, 200bar operating pressure, Ex protected

Please ask KEM or your nearest dealer for the possible combinations and the best solution for your application.

### 1.3.2 Accessories

Ordering Code	Description
(Contact KEM)	Connecting Cable KCM ⇔ KCE80xx-SG-* or KCE80xx-SE-*
KRD8001	Additional remote display for the compact version
HSA96	DIN Rail Adaptor for KCE80** -SG-* or KCE80xx-SE-*
IPS9-9	Protective front cover IP65 for KCE80** -SG -*
IPS9-14	Protective front cover IP65 for KCE80** -SE-*

### 1.4 Measuring Principle KCM

Two parallel flow tubes inside the KCM low meter are vibrating at their resonant frequency in opposite direction. Any mass flow passing through the tubes will delay the vibration at the incoming side and accelerate the vibration at the outgoing side. This causes a small time delay between both ends of the tube. This time delay is measured and used to calculate the mass flow through the tubes.

By measuring the resonant frequency of the tubes the mass of the medium and - given a constant volume inside the tubes - the specific gravity of the medium can be calculated.

As both effects are temperature dependent, the temperature is measured via a precise sensor for correcting the temperature effects of flow and density measurement.

As a consequence a coriolis mass flow meter measures directly mass flow, density and temperature of the medium. Knowing the mass flow and the density, also the volume flow can be calculated.

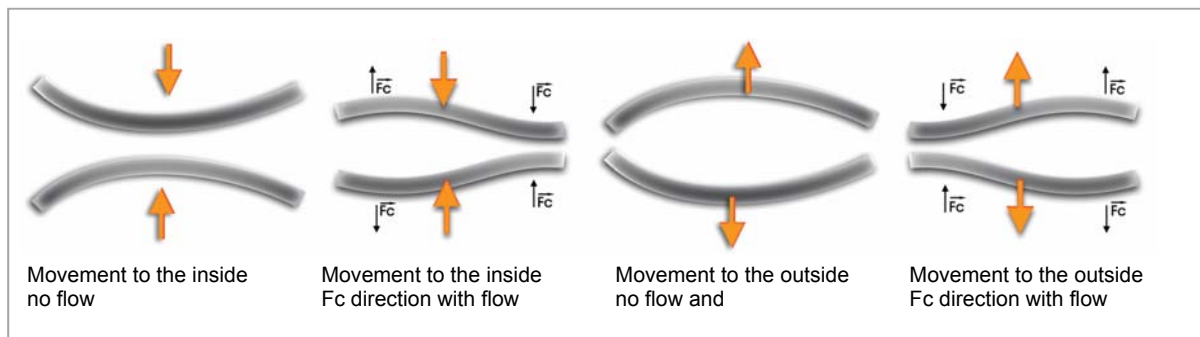


Fig. 3: Flexions of the tubes with and without flow

## 2 Getting started

### 2.1 Unpacking

Verify that you have received the following items:

When you ordered a compact version:

- KCMxxxx... with mounted electronics
- User's manual

When you ordered a remote version

- KCMxxxx...(without electronics)
- KCE80xx...
- Connecting cable (with KCE80xx-W\* just fixed to the KCE)
- User's manual

## 2.2 Operating Elements

### 2.2.1 KCE80xx-WG and compact version

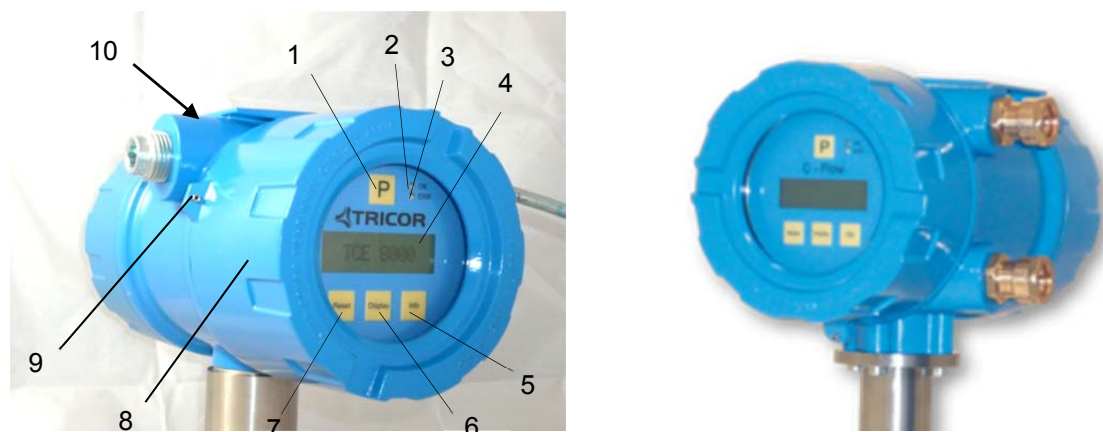


Fig. 4: Operating Elements of KCE80xx-WG and compact version

1 = Pushbutton “P”, activates / selects the different menus and confirms the settings

2 = LED “OK”, flashes green when there is no error

3 = LED “ERR”, flashes red when an error occurs

4 = Display

5 = Pushbutton “Info”, normal: selects the error menu, SETUP: softkey

6 = Pushbutton “Display”, normal: toggles the display, SETUP: softkey

7 = Pushbutton “Reset”, normal: resets the batch counter, SETUP: softkey

8 = Front cover

9 = Set screw for front cover (varying position)

10 = Screw for protective ground

Wall mount version only (not shown on the pictures):

Cable to the meter KCMnnnn, length as ordered (standard 3m) or junction box

Wall mounting bracket

For the rear view see chapter 2.3

## 2.2.2 KCE80xx-SG and KCE80xx-SE



Fig. 5: Operating Elements of KCE80xx-SG



Fig. 6: Operating Elements of TCE80xx-SE-\*Ex

1 = Pushbutton "P", activates / selects the different menus and confirms the settings

2 = LED "OK", flashes green when there is no error

3 = LED "ERR", flashes red when an error occurs

4 = Display

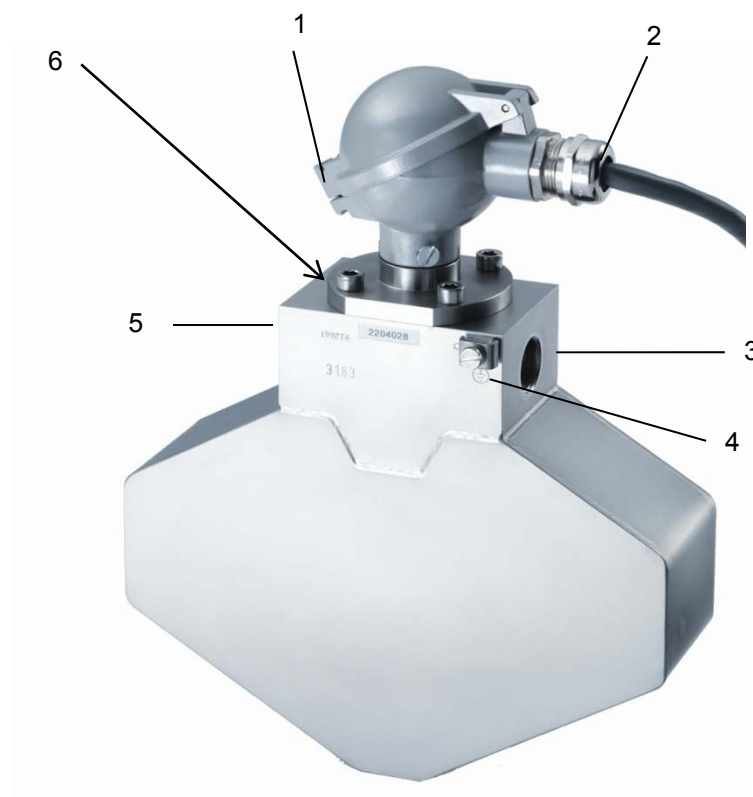
5 = Pushbutton "Info", normal: selects the status menu, SETUP: softkey

6 = Pushbutton "Display", normal: toggles the display, SETUP: softkey

7 = Pushbutton "Reset", normal: resets the batch counter, SETUP: softkey

For the rear view see chapter 2.3

### 2.2.3 KCMxxxx.1... (remote version)



**Fig. 7: Operating Elements KCM**

- 1 = Locking screw for screw type terminals
- 2 = Cable gland for cable to the KCE
- 3 = Fluid output, flange / thread as ordered
- 4 = Screw for protective ground (KCM0300 through 3000 only)
- 5 = Fluid input, flange / thread as ordered
- 6 = M6 mounting threads (back side, option, KCM0300 through 3000 only)

## 2.3 Pin Assignments

### 2.3.1 KCE80xx-WG and compact version (standard housing, non Ex)

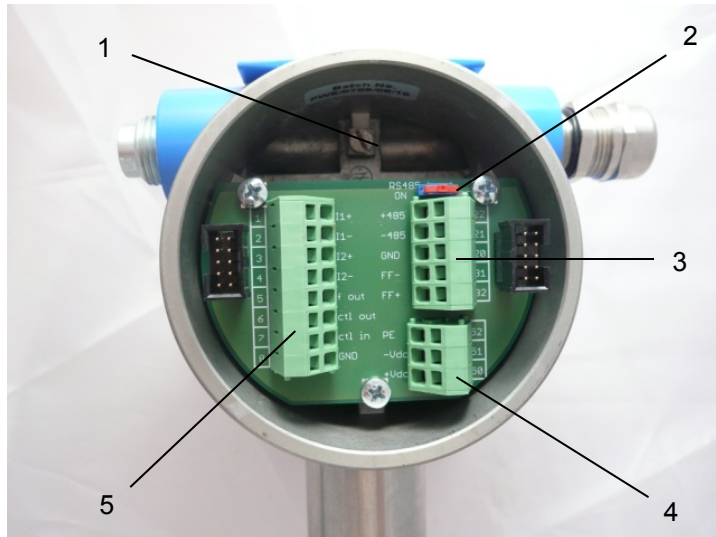


Fig. 8: Electrical terminals KCE80xx-WG and compact version

- 1 = Terminal screw for protective ground
- 2 = Switch for terminating resistor for the RS485 interface
- 3 = Terminal block for interface (RS485 and / or FF)
- 4 = Terminal block power supply
- 5 = Terminal block for I/O signals

### **KCE Terminal connections**

1	+ I1	current loop 1 positive terminal
2	- I1	current loop 1 negative terminal
3	+ I2	current loop 2 positive terminal
4	- I2	current loop 2 negative terminal
5	F out	Frequency / pulse output
6	CTL OUT	Control output
7	CTL IN	Control input
8	GND	Ground (for pins 5 through 7)
20	COMMON	Common (for pins 21 and 22)
21	- RS485	RS485 negative line
22	+RS485	RS485 positive line
31	FF-	Foundation fieldbus, negative rail
32	FF+	Foundation fieldbus, positive rail
24V DC Supply		
50	+ 24 VDC	Positive supply voltage (24 VDC)
51	- 24 VDC	Supply ground
52	PE	Protective Ground
100 – 240V AC Supply		
90	L	Life (AC voltage)
91	N	Neutral
52	PE	Protective Ground

### 2.3.2 KCE80xx-WE and compact version (Ex)

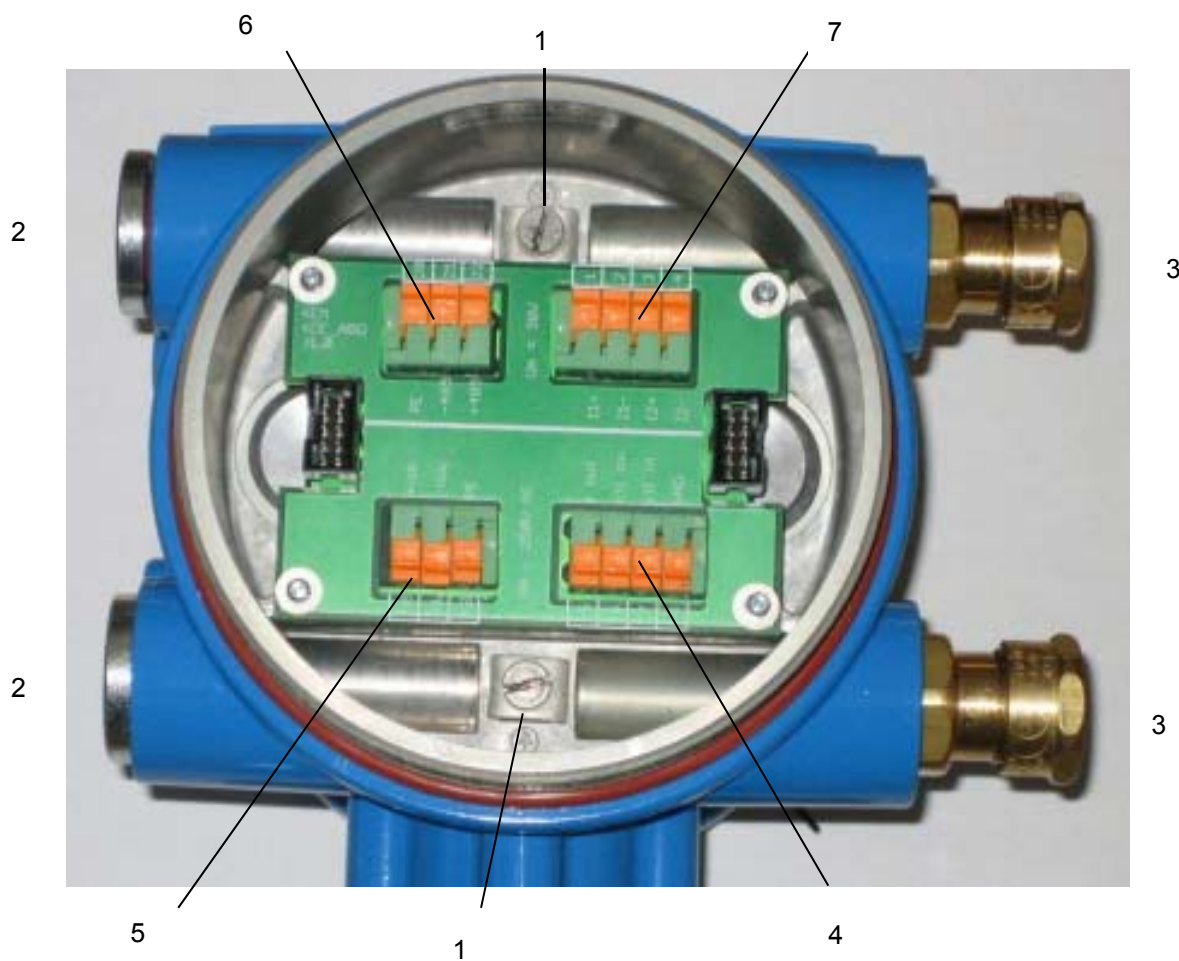


Fig. 9: Electrical terminals TCE80xx-E-\*Ex and compact version

- 1 = Terminal screw for protective ground
- 2 = Blind cover for cable opening (various numbers and positions)
- 3 = Cable gland (various numbers and positions)
- 4 = Terminal block for digital I/O signals ( $U_M = 250V$  DC)
- 5 = Terminal block power supply ( $U_M = 250V$  DC)
- 6 = Terminal block for Interface ( $U_M = 30V$  DC)
- 7 = Terminal block for analog I/O signals ( $U_M = 30V$  DC)

**KCE Terminal connections**

**Terminals with  $U_M = 30V$  DC**

1	+ I1	current loop 1 positive terminal
2	- I1	current loop 1 negative terminal
3	+ I2	current loop 2 positive terminal
4	- I2	current loop 2 negative terminal
20	COMMON	Common (for pins 21 and 22)
21	- RS485	RS485 negative line
22	+RS485	RS485 positive line

With option FF

31	FF-	Foundation fieldbus, negative rail
32	FF+	Foundation fieldbus, positive rail

**Terminals with  $U_M = 250V$  DC**

5	F out	Frequency / pulse output
6	CTL OUT	Control output
7	CTL IN	Control input
8	GND	Ground (for pins 5 through 7)

24V DC Supply

50	+ 24 VDC	Positive supply voltage (24 VDC)
51	- 24 VDC	Supply ground
52	PE	Protective Ground

100 – 240V AC Supply

90	L	Life (AC voltage)
91	N	Neutral
52	PE	Protective Ground

### 2.3.3 Panel mount version KCE80xx-SG (non Ex)

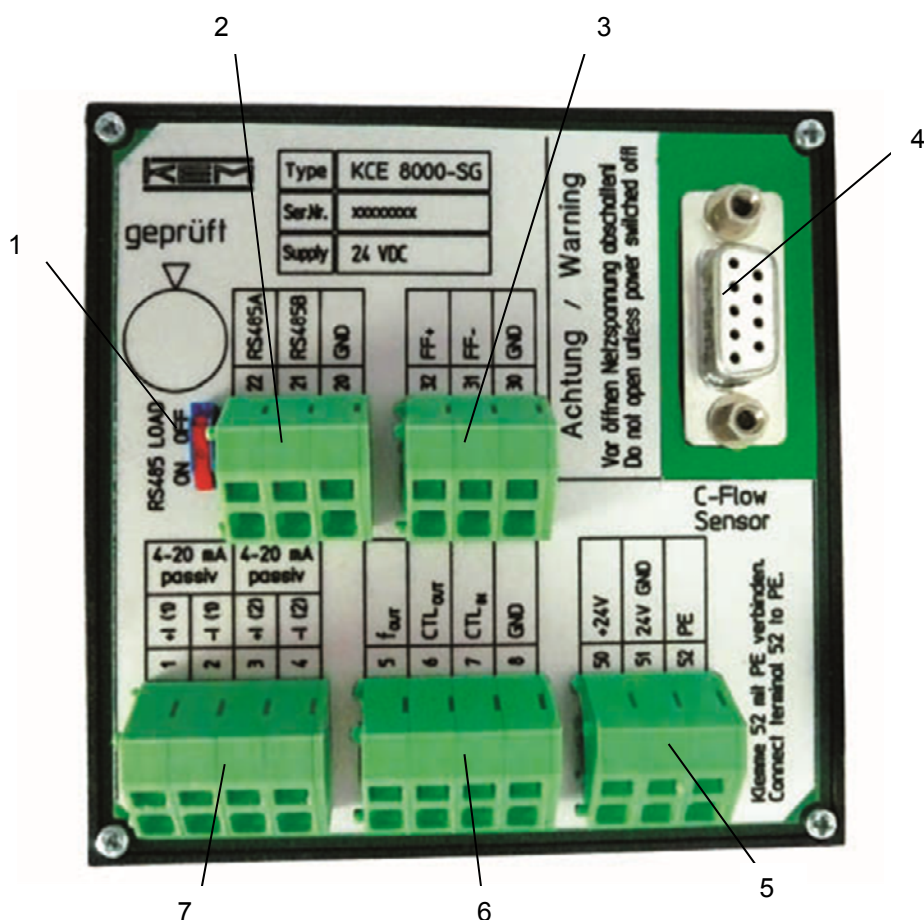


Fig. 10: Electrical terminals KCE80xx-SG

- 1 = Sliding switch for activating the 120 $\Omega$  terminal resistance for RS-485
- 2 = Cage clamp terminals for interface RS-485
- 3 = Cage clamp terminals for interface foundation field bus
- 4 = Connector to the meter, D-Sub 9, female
- 5 = Cage clamp terminals for power supply
- 6 = Cage clamp terminals for digital I/O signals
- 7 = Cage clamp terminals for analog I/O signals

### KCE Terminal connections

1	+ I1	current loop 1 positive terminal
2	- I1	current loop 1 negative terminal
3	+ I2	current loop 2 positive terminal
4	- I2	current loop 2 negative terminal
5	F out	Frequency / pulse output
6	CTL OUT	Control output
7	CTL IN	Control input
8	GND	Ground (for pins 5 through 7)
20	COMMON	Common (for pins 21 and 22)
21	- RS485	RS485 negative line
22	+RS485	RS485 positive line
30	COMMON	Common (for pins 31 and 32)
31	FF-	Foundation fieldbus, negative rail
32	FF+	Foundation fieldbus, positive rail
50	+ 24 VDC	Positive supply voltage (24 VDC)
51	- 24 VDC	Supply ground
52	PE	Protective Ground
90	L	Life (AC voltage)
91	N	Neutral

### 2.3.4 Panel mount version KCE80xx-SL-\*-Ex

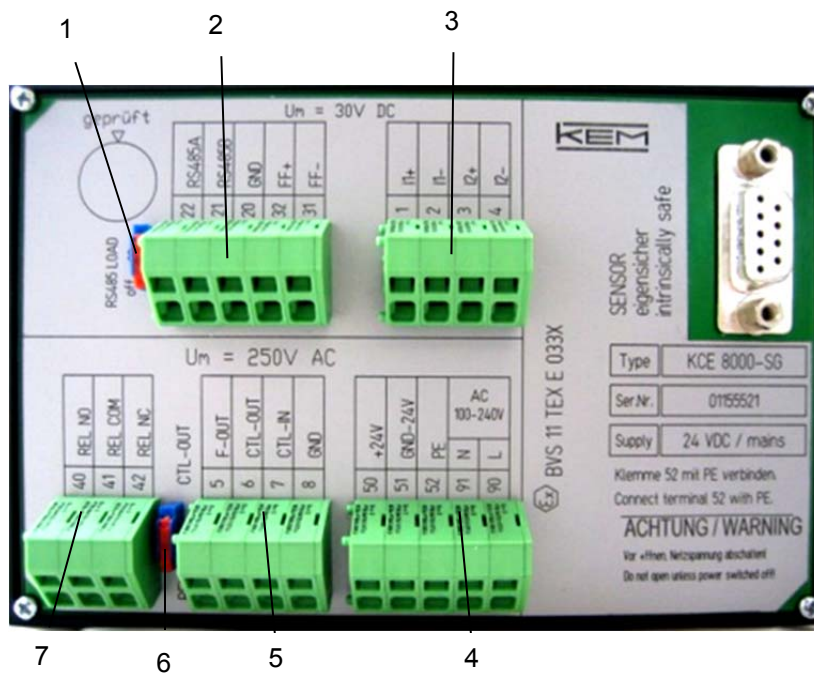


Fig. 11: Electrical terminals KCE80xx-SG-\*-Ex

- 1 = Sliding switch for activating the  $120\Omega$  terminal resistance for RS-485
- 2 = Terminal blocks for interface ( $U_M = 30V DC$ )
- 3 = Terminal blocks for analog I/O signals ( $U_M = 30V DC$ )
- 4 = Terminal block for power supply ( $U_M = 250V DC$ )
- 5 = Terminal block for digital I/O signals ( $U_M = 250V DC$ )
- 6 = Sliding switch for activating the relay output
- 7 = Terminal block for relay ( $U_M = 250V DC$ )

**KCE Terminal connections**

**Terminals with  $U_M = 30V DC$**

1	+ I1	current loop 1 positive terminal
2	- I1	current loop 1 negative terminal
3	+ I2	current loop 2 positive terminal
4	- I2	current loop 2 negative terminal
20	COMMON	Common (for pins 21 and 22)
21	- RS485	RS485 negative line
22	+RS485	RS485 positive line
31	FF-	Foundation Fieldbus negative line
32	FF+	Foundation Fieldbus positive line

**Terminals with  $U_M = 250V DC$**

5	F out	Frequency / pulse output
6	STAT OUT	Status output
7	CTL IN	Control input
8	GND	Ground (for pins 5 through 7)
40	REL NO	Relay normally closed contact
41	REL COM	Relay common
42	REL NC	Relay normally open contact
50	+ 24 VDC	Positive supply voltage (24 VDC)
51	- 24 VDC	Supply ground
52	PE	Protective Ground
90	L	Life (AC voltage)
91	N	Neutral

## 2.4 Quick start

---

### **WARNING!**

As for safety and accuracy reasons many precautions must be taken, read chapter 3 carefully before installing the unit!

---

In case the unit has only to be operated without flow for testing or learning purpose, the following connections have to be made (see chapter 3.2):

- 1) Connect the supply voltage
  - 2) Connect the KCE to the KCM (only required with the remote version)
  - 3) The frequency and analogue outputs as well as the interface may be connected as well, if those features are required
- 

### **WARNING!**

If the unit is connected to a bigger system, for your personal safety connect the protective ground as well!

---

### **WARNING!**

In hazardous areas it is not allowed to operate the unit without proper wiring according to chapter 3.3 and with the housing not properly closed!

---

### 2.4.1 First Operation

Make sure that all mechanical and electrical connections are made properly.

Switch on the power supply. The LED "OK" will flash green.

After the power up sequence the display shows the preselected values (ex factory normally flow and batch)

Switch on the flow. The value indicated in the display should be positive.

In case of an error the LED "ERR" will flash red.

As soon as the unit has reached the operating temperature, make the zero point calibration (see chapter 4.4):

- Switch off the flow
- Wait until the flow is zero
- Start the zero point calibration in the SETUP menu
- Wait until the offset procedure is finished
- Switch on the flow again

The display can be altered by pressing the key "Display".

The error code, the device status and information like serial number, SW version a.s.o. can be viewed by pressing the key "Info" for 3 seconds.

If the function is activated, the BATCH reading can be reset to zero by pressing the key "Reset".

For entering the CONTROL menu press "P" for 3 seconds.

### 2.4.3 CONTROL Menu

In the CONTROL menu all configurations can be made. This includes configuration of the analogue and digital outputs, customizing the display and other settings.

The menu itself is self-explaining, the function of the softkeys (5, 6, 7) is indicated in the display above the pushbutton.

For entering the CONTROL menu press the pushbutton “P” (4) for 3 seconds.

The submenu DISPLAY can be entered without a password as any changes in this submenu will not affect the operation of the unit.

The submenus SETUP, I/O-TEST and SERVICE are password protected for avoiding unintentional changes of the operating parameters.

For SETUP and I/O-TEST the password is “2207”, for SERVICE refer to chapter 6.4.

Change the indicated number “2206” with the softkey “up” (6) to “2207” and confirm with “P” (4).

Select the desired submenu with the softkeys and confirm with “P” (4).

Every setting must be confirmed with “P” (4) for storing the setting or with “E” for exiting without storing.

For leaving the SETUP menu press “E” (7) in the main level.

### 2.4.4 Using the magnet

The Ex versions with the big blue Ex d housing come with a magnet for operating the pushbuttons through the closed window cover.

In hazardous, wet and dusty areas the display cover must not be opened to operate the pushbuttons.

Beside every pushbutton there is a hall sensor which can be operated via the magnet attached to the housing.

For operating the keys hold the magnet to the glass.

The best positions for operating the keys are:

Key	position
P	right edge of the yellow area
Reset	left edge of the yellow area
Display	lower edge of the yellow area
Info	right edge of the yellow area



## 3 Installation

### 3.1 Mechanical

In accordance with this manual the user should select the installation position which fits the application best. To ensure the highest degree of accuracy and repeatability, care should be taken to affix the C-Flow products in a stable process site and minimize the amount of vibration in the installation environment

#### 3.1.1 Installation Guidelines

Coriolis mass flow meters measure the flow of a liquid or gas by vibrating the medium perpendicular to the flow direction and measuring the effect of the inertial force of the medium. Consequently for best performance the meter must be decoupled from external vibrations and the medium must be homogenous.

**External vibration:**

In case of (possible) external vibrations connect the meter mechanically rigidly to a non-vibrating point or – if this is not possible – connect it via vibration dampers.

The meters can be mounted via optional mounting threads on the back side.

In case of vibrating tubes a decoupling via flexible hoses might be recommended.

Piston pumps and other pumps producing a strongly pulsating flow should be decoupled hydraulically via longer pipes, flexible tubes or other measures.

**Inhomogeneous media:**

If a liquid might contain gas bubbles or solid particles, care must be taken that the gas bubbles or the solid particles will not remain in the meter.

If a pure liquid or a liquid with possible gas bubbles is to be measured, the meter should be installed horizontally with the meter showing downwards. This assures that gas bubbles will not accumulate in the measuring tubes.

If a liquid might contain solid particles, the meter should be installed horizontally with the meter showing upwards. This assures that the solid particles will not accumulate in the measuring tubes.

The meters must not be mounted vertically, as according to the diamond shaped tube geometry gas bubbles as well as solid particles would accumulate in the meter.

2 phase media with gas bubbles (like foam) or solid particles (like paints or slurry) can be measured without any problems, if the gas bubbles or solid particles are small compared to the tube diameter and evenly distributed. The mounting guidelines, nevertheless, must be observed.

### 3.1.2 Horizontal Installation

The horizontal installation is the recommended installation.

If the medium might contain solid particles, mount the meter as in position “A”, in all other cases as in position “B”.

Fix the meter to a solid, non-vibrating surface as close to the meter as possible. This could be done via the optional mounting threads.

If no non-vibrating surface is available, vibration dampers might be recommended.

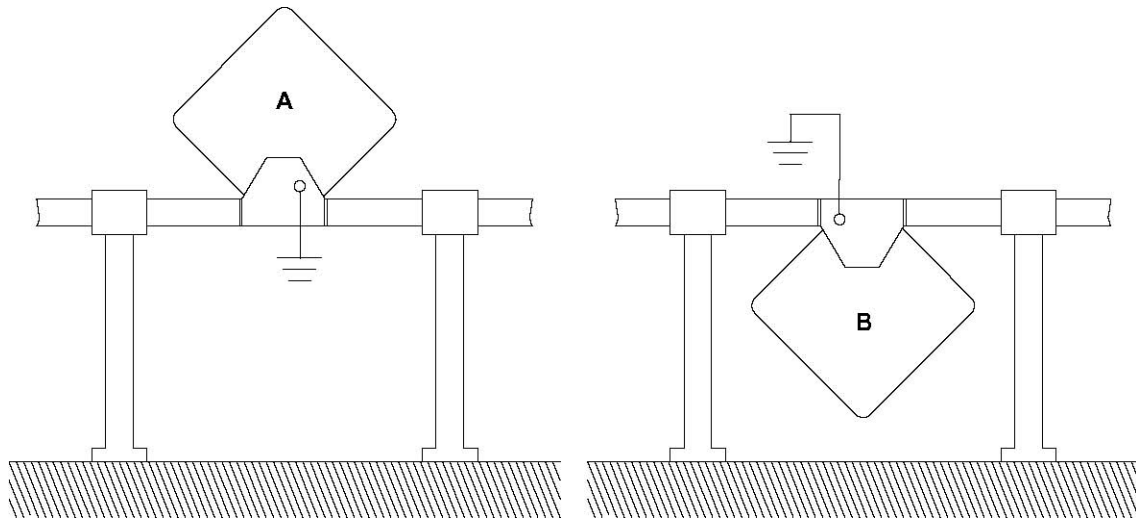


Fig. 12: Recommended Horizontal Installation

### 3.1.3 Vertical Installation

A vertical installation should only be selected, if

- a) the medium contains no deposits.
- b) gas or air bubbles are not expected.

Please consider that the KCM0300 through KCM3000 will not run empty in this position due to the geometric construction of the measuring tubes. When the system is stopped gas or air bubbles may accumulate at the highest point of the tubes. Due to the tube geometry the measuring tubes do not vent automatically in vertical installation position. Gas bubbles may also accumulate at the highest point of the tubes when the mass flow is very low. Generally, gas bubbles will lead to undefined measuring results due to the big density difference.

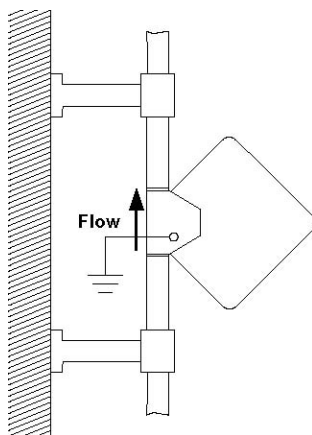


Fig. 13: Vertical Installation

### 3.1.4 Installation in a Drop Line

If a meter must be mounted in a drop line, an orifice and the closing valve are to be located below the meter for making sure, that neither during operation nor after closing the valve the meter will run empty.

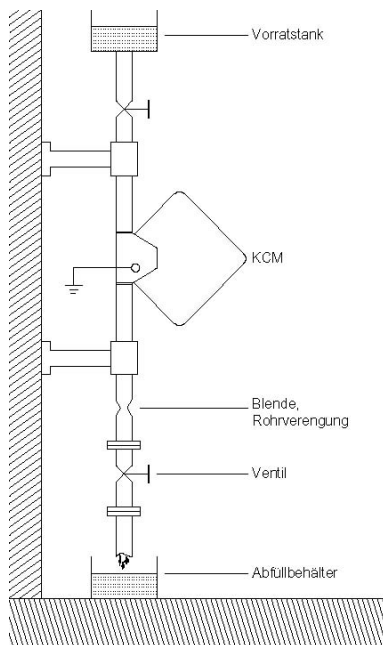


Fig. 14: Installation in a Drop Line

### 3.1.5 Critical Installations

The meters must not be mounted at the highest point of the tubing, if gas bubbles are to be expected (A), or at the lowest point, if solid particles are to be expected (B), as in both cases also the right orientation might not help.

Also the meters must not be mounted in a drop line near the open end (C), as in that case the meter might run empty.

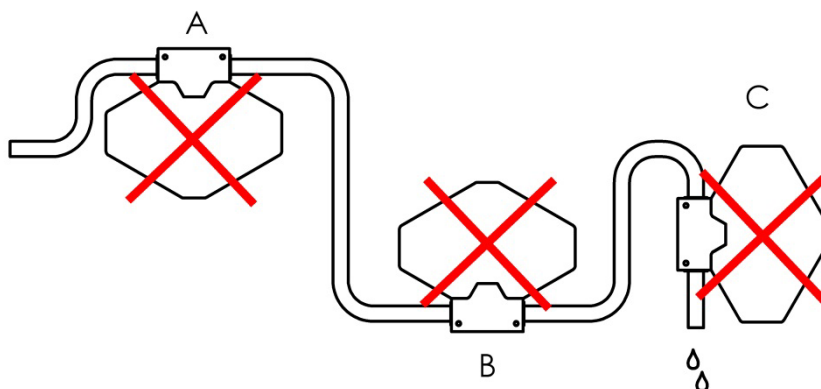


Fig. 15: Critical Installations

### 3.1.6 Mechanical Installation of the electronics (-W and -S version)

#### KCE80xx-WG

The wall mount unit is to be mounted on the wall with 2 screws with 5mm diameter, about 40mm apart. For exact dimensions refer to chapter 7.3.4

#### KCE80xx-WE

The wall mount unit is to be mounted on the wall with 2 to 4 screws with 5mm diameter, about 45mm apart. For exact dimensions refer to chapter 7.3.4

If the mounting point should be located behind the KCE80xx instead beside, unscrew the 4 screws fixing the bracket to the housing, fix the bracket to the wall and reattach the housing to the bracket.

#### KCE80xx-SG

The housing requires an opening in the panel of 92mm x 92mm (KCE80xx-SG) or 139mm x 92mm (KCE80xx-SE) at a maximum wall thickness of 2mm.

Push the KCE80xx-SG into the opening. The springs will fix the unit automatically.

For removing the KCE80xx-SG press the springs towards the housing via a screwdriver.

---

#### **WARNING!**

For mounting the unit in hazardous areas refer to chapter 3.3

---

## 3.2 Electrical installation

Make sure that the unit is properly mounted and the process input and output are connected before making the electrical connections.

This unit must be grounded.

The KCE requires a regulated DC power supply of 24V  $\pm$ 20% or a mains voltage of 100 to 240V AC, depending on the version.

---

**WARNING!**

Never connect a 24V only version to the mains supply or vice versa!

---

The digital inputs and outputs are referred to GND and to the ground potential of the DC supply (= negative pole). The AC supply terminals are electrically isolated from all inputs and outputs.

The ground potential GND is connected to protective ground via a 1k $\Omega$ .

For connecting the KCE, shielded cables must be used. The shield should be connected to the case. If in bigger systems the shield must not present a DC connection for avoiding high ground loop currents, make the ground connection of the shield via a capacitor of e. g. 100nF.

Make sure that the flow meter is grounded.

---

**WARNING!**

Improper grounding and shielding may lead to bad EMC behavior or danger to your health!

---

**NOTE**

Make sure that all cable and wires are connected and fixed properly before applying power to the KCE.

### 3.2.1 Connecting KCE and KCM

With the remote version the KCE and KCM must be connected before making the other electrical installations. If no KCM is connected to the KCE, the KCE will only show an error message after power on.

#### Connecting the cable to the KCM

Open the junction box of the KCM.

Feed the cable from the KCE into the cable gland of the KCM and connect the single conductors as described in tab. Tab. 1.

Adjust the position of the cable in the cable glands and close the cable gland.

Terminal	Signal	Color
1	Driver +	Grey
2	Driver -	Pink
3	Sensor A +	Blue
4	Sensor A -	Red
5	Sensor B +	White
6	Sensor B -	Brown
7	Pt1000 +	Green
8	Pt1000 -	Yellow
PE	Protective ground	Yellow / green

Tab. 1: Connections KCMxxxx

Close the top cover of the junction box and fix it with the screw.

#### Connecting the cable to the KCE80\*\*-SG-\* or KCE80\*\*-SE-\*

Put the D-Sub connector of the cable to the connector "sensor" on the back side of the housing.

#### Connecting the cable to the TCE80\*\*-WG with junction box

With the KCE80\*\*-WG with junction box the cable is not fixed to the KCE and must be connected separately.

Open the junction box of the KCE.

Feed the cable from the TCM into the cable gland of the KCE junction box.

Push the cable end sleeves into the terminals according to tab. Tab. 1. There is no tool required to connect the cables.

If cables without end sleeves are to be connected or if cables have to be removed, open the terminal by pressing a small screwdriver into the orange operator of the terminal.

Adjust the position of the cable in the cable glands and close the cable gland.

Close the top cover of the junction box and fix it with the screw.

### 3.2.2 Electrical Installation of Wall Mount and Compact Version

Connect the KCM to the KCE (see chapter 3.2.1, remote version only)

Open the safety screw at the display cover of the unit with the provided Allen key.

Remove the display cover of the KCE by turning it counter clockwise.

Pull out the display

Prepare the cable for installation:

- Separate the single conductors for about 12 cm
- Strip the end and cover it with a cable end sleeve
- Connect a 7 cm long stranded wire to the shield

Feed the cable through the cable gland.

Connect the shield to the PE screw.

**NOTE:**

In bigger installations a separate PE connection with a high cross section ( $> 1.5\text{mm}^2$ ) is recommended for avoiding high equalizing currents in the shield.

Connect the individual cables to the cage clamp terminals as required.

The Ex versions have self-opening terminals. Push the cable end sleeves into the terminals. There is no tool required to connect the cables.

If cables without end sleeves are to be connected or if cables have to be removed, open the terminal by pressing a small screwdriver into the orange operator of the terminal.

The non-Ex versions have standard cage clamp terminals. Push a small screwdriver into the upper (smaller) opening of the terminal, feed the cable into the bigger opening and pull out the screwdriver.

For the right connections refer to chapter 3.2.4 to 3.2.6.

Adjust the position of the cable in the cable gland in that way that the single conductors remain short but free of tension and fix the cable in the cable gland.

Put in the display again. The display can be put in at 4 orientations separated by  $90^\circ$ .

Perform – if necessary – a function test and make the necessary settings (see chapter 4).

Close the display cover.

Fasten the safety screw if necessary.

### 3.2.3 Electrical Installation of Panel Mount Version

Connect the KCM to the KCE (see chapter 3.2.1)

Prepare the cable for installation:

- Separate the single conductors as required
- Strip the end and cover it with a cable end sleeve
- Connect a stranded wire to the shield

Connect the shield to the PE terminal.

**NOTE:**

In bigger installations a separate PE connection with a high cross section ( $> 1.5\text{mm}^2$ ) is recommended for avoiding high equalizing currents in the shield.

Connect the individual cables to the cage clamp terminals as required.

Push a small screwdriver into the upper (smaller) opening of the terminal, feed the cable into the bigger opening and pull out the screwdriver.

For the right connections refer to chapter 3.2.4 to 3.2.6.

Perform – if necessary – a function test and make the necessary settings (see chapter 4).

### 3.2.4 Power Supply and Grounding

#### 3.2.4.1 24V DC Power Supply

The DC powered KCE requires a regulated DC power supply of  $24\text{V} \pm 20\%$ .

The power supply input of the KCE is protected by a 315mA fuse. As a protection against fire in case of a short in the supply cable, the output of the power supply must be equipped with a fuse with a rating not higher than the current carrying capacity of the cable used.

For connecting the KCE 8000 use shielded cables. If several cables are used, each cable should be shielded properly.

Connect the ground of your power supply to terminal 51 and the +24V to terminal 50. (See Fig. 16)

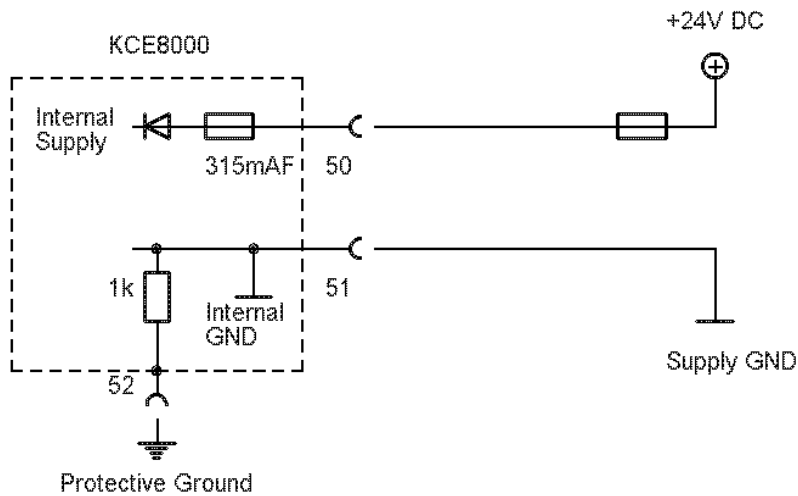


Fig. 16: Wiring diagram for power connections, DC operation

Terminal	Description
50	Positive supply Voltage, 24V $\pm$ 20%, referred to pin 51
51	Ground potential for supply voltage
52	Protective ground

The ground terminals 8, 20 and 51 are internally connected together.

Ground and protective ground are internally connected via a 1k $\Omega$  resistor. The resistor will thermally withstand a potential difference of up to 30V between PE and GND but for proper operation this difference should be limited to 5V.

### 3.2.4.2 100 to 240V AC Mains Supply

The AC version of the KCE requires a nominal power supply of 100 – 240V AC and operates over a range of 90 – 264V AC.

The power supply input of the KCE is protected by a 1A slow blow fuse. As a protection against fire in case of a short in the supply cable, the output of the power supply must be equipped with a fuse with a rating not higher than the current carrying capacity of the cable used.

For the mains powered units a good connection of PE is mandatory. The cross section of the PE cable should be at least the cross section of the supply cable or 1mm<sup>2</sup>, whichever is higher.

Connect the supply to terminal 91 (neutral) and 90 (life). (See Fig. 17)

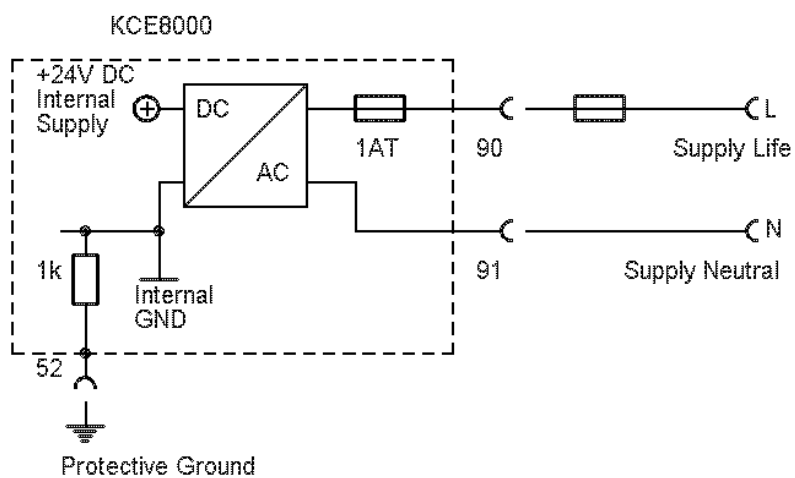


Fig. 17: Wiring diagram for power connections, AC operation

Terminal	Description
90	Mains life, referred to pin 51
91	Mains neutral
52	Protective ground

The ground terminals 8, 20 are not connected to terminal 91.

### 3.2.4.3 DC and AC supply

The KCE80xx-SG-B can be connected to a 24V DC and a mains supply simultaneously. The unit will operate properly as long as one of the 2 supplies is present.

### 3.2.5 Connecting the control inputs and outputs

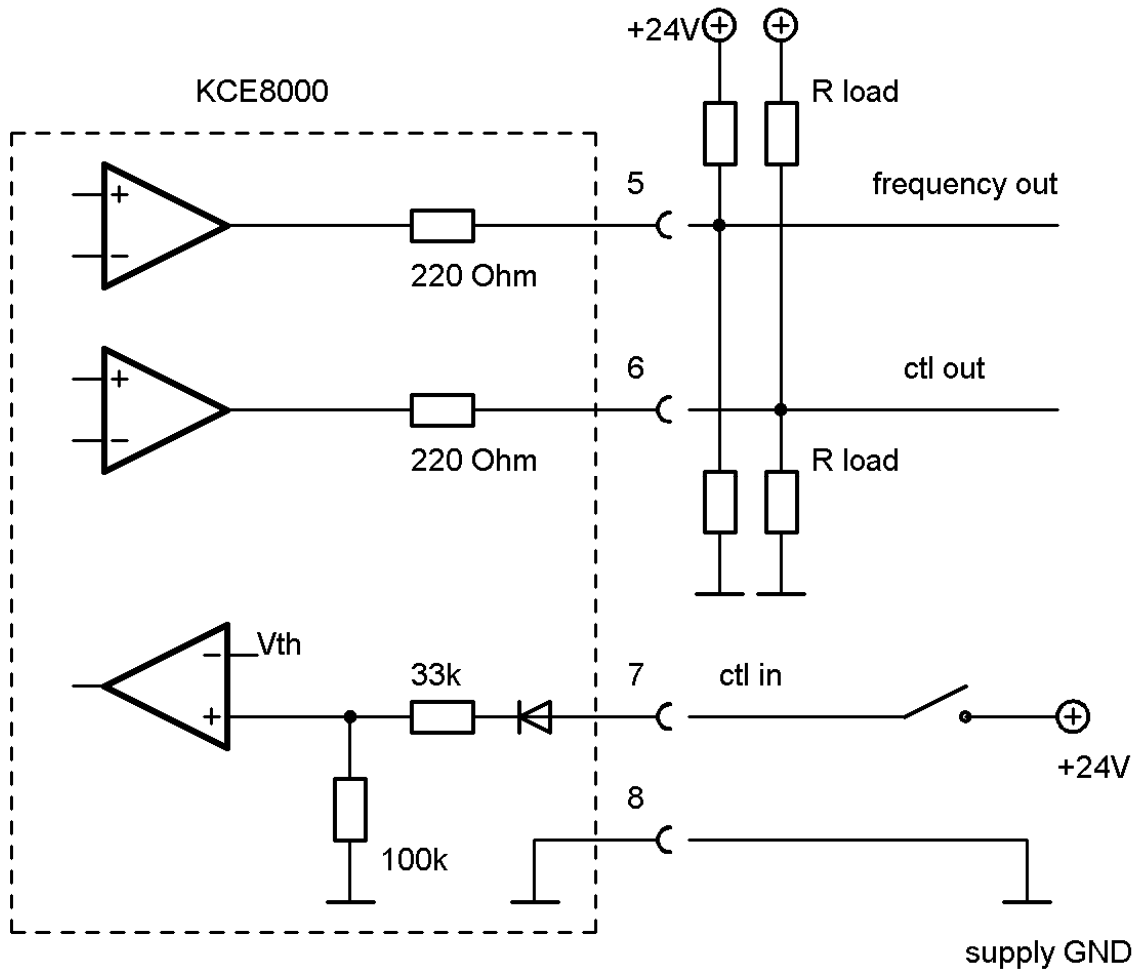


Fig. 18: Wiring diagram for digital I/O connections

Terminal	Description
5	Frequency output, active, referred to pin 8
6	Status output, active, referred to pin 8
7	Control input, active high, referred to pin 8
8	Ground potential for digital I/O- pins.

The frequency and control outputs are active push-pull outputs with an output resistance of 220Ω. They can be loaded to the positive supply or to ground. For a high output swing the load resistors  $R_{load}$  should not be lower than 1kΩ.

In case of a load resistor to ground the output voltages are:

$$V_{high} = V_{supply} * R_{load} / (220\Omega + R_{load})$$

$$V_{low} < 1V$$

In case of a load resistor to the positive supply the output voltages are:

$$V_{high} > V_{supply} - 1V$$

$$V_{low} = V_{supply} - V_{supply} * R_{load} / (220\Omega + R_{load})$$

The control input requires a high voltage of minimum 6.5V and a minimum input current of 0.1mA.

The ground terminals 8, 20 and 51 are internally connected together.

Ground and protective ground are internally connected via a 1kΩ resistor. The resistor will thermally withstand a potential difference of up to 30V between PE and GND but for proper operation this difference should be limited to 5V.

### 3.2.6 Connecting the analog outputs

The KCE8000 provides 2 independent passive 4-20mA current loops CURRENT 1 and CURRENT 2.

The current loops are isolated from each other and from the power supply.

For operation an external supply of 8 to 30V (nominal 24V) is required.

The minimum voltage between terminal 1 and 2 or 3 and 4 respectively is 8V.

The minimum load resistance is 0Ω, the maximum is determined by the supply voltage.

At a given supply voltage the maximum load resistance can be calculated as:

$$R_{load(max)} = (V_{supply} - 8V) / 22mA$$

For 24V minus 10% supply this gives a maximum value of 620Ω.

With a given load resistance, the minimum supply voltage can be calculated as:

$$V_{supply(min)} = 8V + R_{load} * 22mA$$

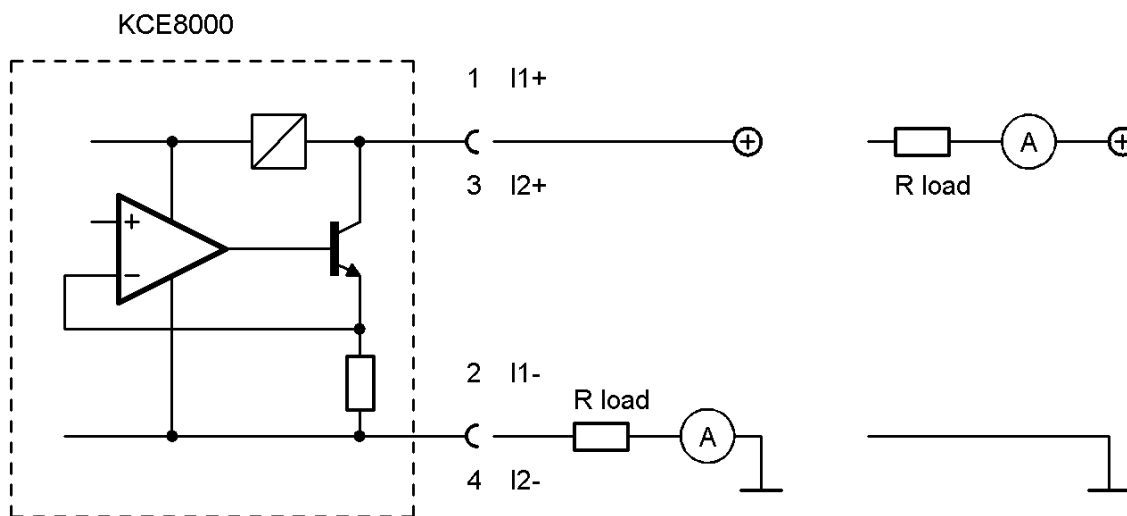


Fig. 19: Wiring diagram for 4-20mA current loop

Terminal	Description
1	Positive terminal of the passive 4-20mA loop 1
2	Negative terminal of the passive 4-20mA loop 1
3	Positive terminal of the passive 4-20mA loop 2
4	Negative terminal of the passive 4-20mA loop 2

As the terminals are floating, the load resistor and the current meter can be placed in the positive or in the negative supply rail (see Fig. 19, right or left circuit).

Connect the shield of the cables to protective ground (terminal 52).

### 3.3 Ex Installation

---

#### **WARNING!**

In hazardous locations all installations must only be carried out by qualified personnel!  
Switch off all power supplies before installing or uninstalling the unit in hazardous locations!

---

#### 3.3.1 Locating the Compact Version

The KCM\*\*\*\*-C\*-\*\*-\*\*-\* -Ex is explosion proof with EX d for the electronics and Ex i for the meter.  
The inputs and outputs are not power limited and must not be used to drive intrinsically safe circuits

---

#### **WARNING!**

Never open any cover in hazardous locations with any supply or I/O circuits alive!

---

#### 3.3.2 Locating the Remote Version with KCE80\*\*-WE\*-\*\*-Ex

##### **NOTE**

For use in hazardous locations the KCM as well as the KCE must be Ex versions!

The KCM\*\*\*\*-C\*-\*\*-\*\*-\* -Ex is intrinsically safe when driven by the corresponding KCE80xx-Ex.  
The KCE80\*\*-WG\*-\*\*-Ex is explosion proof "EX d". It contains the safety barriers for the KCM.  
The inputs and outputs of the KCE are not power limited and must not be used to drive intrinsically safe circuits  
The KCE80\*\*-WG\*-\*\*-Ex can be located inside and outside the hazardous area.

---

#### **WARNING!**

Never open any cover of the KCE80\*\*-WG\*-\*\*-Ex in hazardous locations with any supply or I/O circuits alive!

---

#### 3.3.3 Locating the Remote Version with KCE80\*\*-SE\*-\*\*-Ex

##### **NOTE**

For use in hazardous locations the KCM as well as the KCE must be Ex versions!

The KCM\*\*\*\*-C\*-\*\*-\*\*-\* -Ex is intrinsically safe when driven by the corresponding KCE80xx-Ex.  
The KCE80\*\*-SG\*-\*\*-Ex is not explosion proof and only provides the intrinsically safe connections to the KCM.  
The inputs and outputs of the KCE are not power limited and must not be used to drive intrinsically safe circuits  
The KCE80\*\*-SG\*-\*\*-Ex must be located outside the hazardous area.

#### 3.3.4 Electrical connections

##### **Compact and Wall Mount Version**

The supply terminals and the digital I/O terminals are rated for  $U_M = 250V$  whereas the analog output and interface terminals are rated for  $U_M = 30V$  DC.

For making the required connections proceed as follows:

Prepare the cable and the KCE as described in chapter 3.2.

Connect the cable as described in chapter 0 ff. and in chapter 3.3.5 to 3.3.7.

Close the cable glands properly before applying power to the TCE80\*\*!

---

**WARNING!**

The Ex d protection of the housing is void, if any of the cable glands is not closed properly!

---

**Panel Mount Version**

The supply terminals and the digital I/O terminals are rated for  $U_M = 250V$  whereas the analog output and interface terminals are rated for  $U_M = 30V$  DC.

Connect the unit as described in chapter 3.2.3 ff. and chapter 3.3.5 to 3.3.7.

### 3.3.5 Power Supply and Grounding

For operation in hazardous areas a good connection of PE is mandatory. The cross section of the PE cable must be at least the cross section of the supply cable or  $1\text{mm}^2$ , whichever is higher.

The supply terminals (50, 51 for 24V DC or 90, 91 for mains operation) are designed for a rated voltage of 250V AC.

---

**WARNING!**

Applying 250AC to the DC supply terminals (50, 51) will not affect the Ex safety of the KCE or KCM, but will damage the supply circuit of the KCE!

---

The KCE80\*\*-SG-B-Ex can be connected to a 24V DC and a mains supply simultaneously. The unit will operate properly as long as one of the 2 supplies is present.

For the circuit diagrams and the general description refer to chapter 3.2.4.

### 3.3.6 Digital Control Inputs and Outputs

The digital I/O terminals are designed for a rated voltage of 250V AC.

---

**WARNING!**

Applying 250AC to the digital I/O terminals (5, 6, 7, 8) will not affect the Ex safety of the KCE or KCM, but will damage the I/O board of the KCE!

---

For the circuit diagrams and the general description refer to chapter 3.2.5.

### 3.3.7 Analog Outputs

The analogue current output terminals are designed for a rated voltage of 30V AC.

The outputs are protected against wrong polarity. Voltages below 30V will not damage the outputs nor affect the Ex safety.

---

**WARNING!**

Applying more than 30V DC to any of the outputs will damage the KCE and destroy the protection of the KCM!

If more than 30V have been applied to any of the analog output pins, the unit must be returned to KEM for repair as the safety barrier might be destroyed!

---

For the circuit diagrams and the general description refer to chapter 3.2.6.

## 4 Manual Operation

### 4.1 Power On Sequence and Principles of Manual Control

The power up sequence gives the following information, each for about 2 second:

**CORIOLIS  
C-FLOW**

**KCE8000**

This gives the type of electronics. At the time being the types KCE8001 (low power) and KCE8011 (high power) are available.

**SENSOR TYPE  
KCM0300**

This gives the sensor size. At the time being Sensors from KCM0300 (300kg/h max.) to KCM3000k (3000kg/h max.) are available

**SW MAIN  
Rev.: V2.00**

This indicates the SW version of the main processor.

**SW DISPLAY  
Rev.: V2.00**

This indicates the SW version of the display processor.

**READY**

If changes to the settings were made before the last power down and not saved to the backup EEPROM, the following message appears:

\*\*\* ..... WARNING ..... \*\*\*  
 NO ACTUAL RAM BACKUP  
 SEE MANUAL  
 OK

If no key is pressed the warning will disappear automatically after 10 seconds.  
 For further information refer to chapter 4.5.8.

Now the KCE8000 switches to the measuring mode, displaying the default screen:

0.000<sup>RATE</sup>  
 0.00<sup>TOTAL</sup>

The green LED "OK" flashes with a 1 second period. In case of an error the red LED "ERR" flashes.

In manual control the KCE is menu driven and provides 2 operational modes, the "Measuring Mode" and the "Control Mode".

In the measuring mode the display shows the preselected measured values and all 4 pushbuttons have the function printed on them. The switch over between the different measuring displays and the error display can be made at any time without interrupting the measurements.

In the control mode the 3 pushbuttons below the display have varying functions. The actual function is indicated in the display, just above the pushbutton.

In the control menu all necessary settings can be made.

The control menu contains the 5 submenus "ZERO OFFSET", "DISPLAY", "SETUP", "I/O-TEST" and "SERVICE".

For protecting the unit against unintentional changes by unauthorized personnel, the menus "ZERO OFFSET", "SETUP" and "I/O-TEST" are protected by a user password and the menu "SERVICE" by a service password.

For the description of the control menu see chapter 4.5.

### 4.1.1 Using the magnet

In hazardous, wet and dusty areas the display cover must not be opened to operate the pushbuttons.

Beside every pushbutton there is a hall sensor which can be operated via the magnet attached to the housing.

For operating the keys hold the magnet to the glass.

The best positions for operating the keys are:

Key	position
P	right edge of the yellow area
Reset	left edge of the yellow area
Display	lower edge of the yellow area
Info	right edge of the yellow area



## 4.2 Setup guidelines

Ex factory the C-Flow mass flow meter come with a setup optimized for normal applications. In more than 90% of the applications no further optimization except a regular offset adjustment is required.

The different possibilities for optimizing the settings are described below.

### 4.2.1 Meter Mode

A coriolis mass flow meter measures the mass flow and the density and can calculate the volume flow.

For avoiding strange effects with the total values when changing the dimensions, the KCE8000 can be set up as a mass flow OR a volume flow meter.

When set up as mass flow meter, only mass and mass flow engineering units can be selected, when set up as volume flow meter, only volume and volume flow engineering units can be selected.

For changing the meter mode refer to chapter 4.5.6.1.

### 4.2.2 Offset Calibration

In contrast to a PD meter, a coriolis mass flow meter has no “natural” zero. At no flow the measured time shift is nearly zero, but not exactly. The offset calibration determines this offset and corrects the measured value correspondingly.

As the offset depends slightly upon the temperature, the density of the medium and the operating pressure, it is strongly recommended to make the offset procedure under working conditions, i.e. with the medium to be measured and at operating pressure and temperature.

For making the offset calibration refer to chapter 4.4 and 4.5.3.

### 4.2.3 Flow filter

The rough data of a mass flow meter are relative noisy. For having a stable reading a filtering of the calculated flow is required.

The filters in the KCE8000 are set via the time constant  $t$ . The time constant is the time the output needs after a jump from  $x$  to 0 to go to  $x/e = x/2.72$ . A higher time constant means more stable reading but also a slower reaction to changing flows.

A rough relation between the time and the filtered flow value after a jump is

Elapsed time	Remaining error (% of the step)
1 * t	30
2 * t	10
3 * t	3
4 * t	1

A linear filter as it is realized in the KCE8000 electronics just delays the flow reading and consequently the total. Independent of the slope (fast or slow) of the rising and falling flow, the error of the internally calculated total and at the frequency output cancel out, if the flow rises from zero (or any other value) and later goes back to the starting value. For getting a correct total via the display or the frequency output, it is just necessary to wait long enough after the flow is switched off.

For best results the KCE8000 electronics provide 2 filters.

The FLOW FILTER filters the mass flow before calculating other parameters like volume flow, total or the frequency and current outputs. For normal applications a moderate filtering with  $t = 1$  s is recommended.

The DISPLAY FILTER filters the flow display additionally to the FLOW FILTER. It does not affect any other parameter or any of the outputs. The default setting is  $t = 1$  s.

If the flow is fast changing or sometimes makes a jump and the outputs have to react as fast as possible, set FLOW FILTER to  $t < 1s$ . If nevertheless the flow display has to be stable for better readability, the DISPLAY FILTER can be increased.

For setting up the FLOW FILTER refer to chapter 4.5.6.2, for the DISPLAY FILTER to chapter 4.5.4.1.

#### 4.2.4 Cutoff

As mentioned above, a mass flow meter has no natural zero and the rough data are noisy. Consequently with now flow a meter would indicate and give out continuously a small fluctuating flow.

The parameter CUTOFF is used to provide a clear zero. If the calculated and filtered flow is below cutoff, the meter indicates zero, the total values remain unchanged and the outputs show zero flow as well.

The value for CUTOFF must be above the noise floor in the given application and well below the minimum flow to be measured.

As a good compromise the default value for CUTOFF is 0.5% of the full scale range of the meter.

For setting CUTOFF refer to chapter 4.5.6.3.

#### 4.2.5 Step response

Sometimes it is necessary to react fast to a fast changing flow, but also to have a stable output, if the flow is (mostly) constant. This cannot be achieved by adjusting the flow filter.

The parameter STEP RESPONSE provides a fast reaction at fast changing flow, also the filter constant is high.

If the difference between the measured flow and the filtered flow is smaller than the step response value, the flow filter remains active. If the difference is higher than step response, the filter is cleared and filled with the new value.

The recommended value for constant or slowly changing flow is 99% (the default value ex works). If the unit has to react to fast changing flow, the optimum value depends on the individual situation. For ON / OFF operation a value of half the ON flow is recommended.

If STEP RESPONSE is set too low, even small changes in flow or even the internal noise will activate the step response function and partially or all the time deactivate the filter, leading to noisy readings and noisy output signals.

For setting STEP RESPONSE refer to chapter 4.5.6.4.

#### 4.2.6 Interaction of the parameters

As each of the 3 parameters affects the calculation of the flow in a different way, a bad combination of different parameters can lead to systematical errors.

##### FLOW FILTER and CUTOFF

If the filter constant is set to a high value, the calculated flow is delayed compared to the actual flow. In ON-OFF operation this leads to the fact that it takes a long time until the calculated flow settles to the ON or OFF value. The total value remains correct if the unit measures long enough after the flow got switched off. If cutoff is set to a high value, the meters stops measuring too early and consequently the calculated total is too low. Also the number of pulses at the frequency output is too low. The error is systematic.

##### NOTE

In ON-OFF operation high values for the flow filter combined with high values for cutoff must be avoided! Jumps of the flow not going down to zero are not affected by cutoff.

##### FLOW FILTER and STEP RESPONSE

As described above, a linear filter just delays the flow reading and consequently the total but does not alter the final total.

If the step response is activated, a nonlinear term is added to the filter. The indicated flow will follow more closely the total flow, but the remaining deviation depends on the values for the filter and for step response, but also on the slope of the flow change and on the size of a step.

If the flow changes slowly or a jump is smaller than step response, the step response function will not be activated and remains linear all the time, producing the normal delay.

If the flow changes fast and the step is higher than step response, the filter will be made faster, the indicated flow follows more closely the actual flow and the delay will be smaller.

In ON-OFF operation with a fast rising and slowly falling flow a systematic positive error is to be expected. If the rising is slow and the falling fast, the error will be negative.

---

### **WARNING!**

If step response is used (e.g. for good reaction to fast changing flow), checking the accuracy for the given application is strongly recommended!

---

## 4.3 Measuring mode

### 4.3.1 Function of the keys

In the measuring mode all pushbuttons have a fixed function:

P	Opens the Control Menu if pressed for about 3 seconds
Reset	Resets the batch counter to zero, if the function "KEY RESET" is enabled
Display	Toggles the display between the 2 preselected settings.
Info	Opens the info menu

### 4.3.2 Display selection

The KCE provides 2 presettable displays. Ex work display 1 shows the flow and the total value, display 2 shows density and temperature.

In the "fixed mode" the display selected by the user remains active until the other display is selected.

For changing from on display to the other just press the pushbutton "Display".

In the "alternate mode" the unit toggles between display 1 and 2 every 5 seconds. In this mode the pushbutton "Display" is without function.

For changing the content of the 2 displays refer to chapter 4.5.4.

### 4.3.3 Resetting the batch value

For easy batching in local operation the KCE provides the possibility to reset the batch value by pressing the pushbutton "Reset".

For protecting the unit against unintentional resetting of the batch value, this function can be disabled.

Ex work the function is disabled.

For changing the setting refer to chapter 4.5.7.4.

### 4.3.4 Error Menu

For easy debugging in case of a malfunction of the system, the KCE provides an info and error menu.

The content of the info and error menu is not of interest for normal operation and some information is only readable for trained personnel.

For entering the menu press the pushbutton "Info" for about 3 seconds.

The display shows "NO ERROR" or one or more of the following error messages:

Code	Error
1	Amplitude sensor A is out of range (too high or too low)
2	Amplitude sensor B is out of range (too high or too low)
3	Measured time delay is too high
4	Offset adjust procedure is in progress
5	Driver current is not stable
6	Temperature sensor is out of range. Typically indicated if the line is broken or has a short
7	Oscillating frequency too low
8	Oscillating frequency too high
9	Driver current too low

Tab. 2: Error Codes

Press “Info” a second time for getting 8 internal operating parameters:

Code	Value
SA	Sensor voltage A in mV
SB	Sensor voltage B in mV
DR	Driver current in mA
PT	Measured Temperature in °C
FRE	Oscillating frequency in Hz
DEN	Density
OFF	Actual offset value
RUN	Actual time shift

**Tab. 3: List of service parameters**

Press “Info” again for getting general information about the unit:

Code	Value
TYPR:	Sensor type (KCM*)
SER.:	Serial number
SW1:	SW version main board
SW2:	SW version display

**Tab. 4: List of unit info**

By pressing “Info” you can toggle between those 2 displays, for returning to the normal operation press “Display”.

## 4.4 Offset calibration

For best accuracy the C-Flow needs an in situ offset calibration. This calibration zeroes out the ambient effects and increases the measuring accuracy at low flow.

The offset calibration must be carried out with the medium to be measured and should be carried out at a temperature and pressure as close to the normal operation as possible.

### Proceed as follows:

Operate the unit for a while under normal operating conditions for making sure that the actual temperature of the unit equals the normal operating temperature.

Switch off the flow. For best results use a valve in front and one behind the KCM. If the valves are not close to the KCM and / or only one valve is used, wait long enough for being sure that there is no more flow through the KCM.

### NOTE:

If there is a residual flow through the KCM or the KCM is exposed to mechanical shocks during the offset procedure, the resulting value will be wrong.

Start the offset procedure as follows (see also chapter 4.5.3):

- Press “P” for about 3 seconds
- The display shows “ZERO OFFSET”
- Press “P”
- Change the indicated number with “up” to 2207 and confirm with “P”
- Press “SLOW” (recommended) or “FAST”
- The display shows “MAKE ZERO” for 10 to 30 s and counts down to “0”
- Confirm with “Info”

The offset procedure takes about 10 s (fast) or 25 – 30 s (slow). During the procedure the red LED will flash.

For an automatic offset calibration initiated by the central control unit, the control input can be configured as “initiate offset”. In that case the KCE starts an offset procedure each time a high level is applied to the input.

For configuring the input refer to chapter 4.5.7.4.

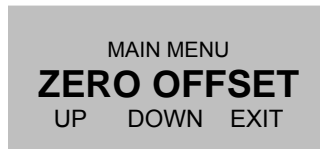
## 4.5 Control Mode

In the control mode the KCE8000 can be adapted to the individual application. As unintentional changes of the settings might cause problems, some submenus are password protected.

To enter the control mode proceed as follows:

Press "P" for about 3 seconds

The display shows:



With the keys "UP" and "DOWN" you can scroll through the main list.

Select the desired submenu and confirm with "P".

### 4.5.1 Function of the keys

In the setup menu some pushbuttons have changing functions, indicated in the display above the pushbutton:

P	Confirms the selection in a list or any kind of inputs
Reset	Performs the indicated function
Display	Performs the indicated function.
Info	Performs the indicated function. In most cases exits the current menu point without altering the original value

### 4.5.2 Submenus in the Main Menu

In the Main Menu the following submenus are addressable:

#### **ZERO OFFSET:**

Performing the automatic offset procedure.  
This submenu is password protected.

#### **DISPLAY:**

Presetting the display.  
Changes made in this submenu have no influence on the general function as well on the accuracy of the unit.

#### **SETUP:**

Adjusting the KCE8000 and configuring the inputs and outputs.  
This submenu is password protected.

#### **I/O-TEST:**

Setting the outputs to defined values and displaying the actual status of the control inputs for testing the electrical connections.  
This submenu is password protected.

#### **SERVICE:**

Calibrating KCE8000.  
This submenu is password protected.

### 4.5.3 ZERO OFFSET Menu

Select in the main menu

```
MAIN MENU
ZERO OFFSET
UP   DOWN  EXIT
```

Press "P". The display shows

```
ENTER CODE
2206
LEFT  UP   EXIT
```

Change the indicated number with "LEFT" and "UP" to 2207 and confirm with "P".  
If a wrong code is entered, the display shows "ERROR" for about 2s and then asks for a new input.

When the correct code is entered the display shows:

```
START OFFSET
PROCEDURE
SLOW  FAST  EXIT
```

Press "SLOW" or "FAST". The display shows

```
MAKE ZERO 10 $\mu$ s
OLD ZERO:      0.000 $\mu$ s
NEW ZERO:       $\mu$ s
```

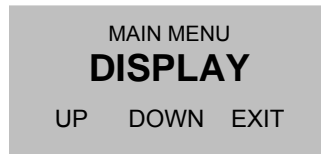
The time counter counts down to zero. The display shows:

```
* END OF ZERO-POINT *
OLD ZERO:      0.000 $\mu$ s
NEW ZERO:      0.123 $\mu$ s
EXIT
```

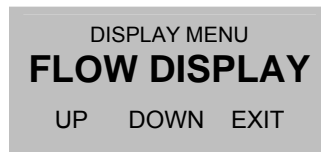
Press "EXIT" to return to the measuring mode.

## 4.5.4 DISPLAY Menu

Select in the main menu



Press "P". The display shows



The following submenus are available:

**FLOW DISPLAY:**

Setting the flow units, the flow decimal point and a flow filter for the display.

**TOTAL DISP:**

Setting the total and batch units and the total and batch decimal point.

**DENS DISP:**

Setting the density units.

**TEMP DISP:**

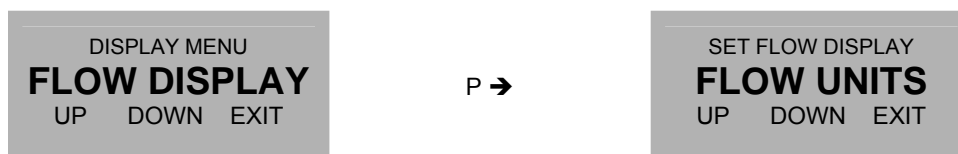
Setting the temperature units.

**DISP MODE:**

Setting the content of the 2 screens, the mode (static or alternating) and the backlight.

### 4.5.4.1 FLOW DISPLAY menu

In the submenu "FLOW DISPLAY" the flow dimensions, the flow decimal point and the flow filter for the display can be set.



Use the keys "UP" and "DOWN" to select the desired submenu and confirm with "P" or skip with "EXIT".

The following submenus are available:

**FLOW UNITS:**

Setting the flow units.

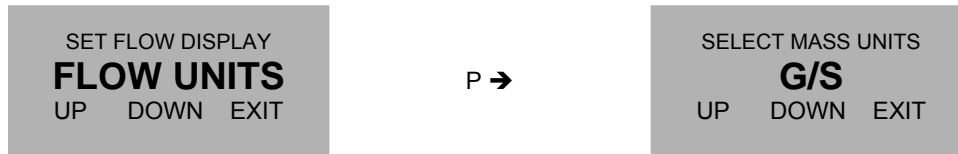
**FLOW DP:**

Setting the flow decimal point.

**DISP FILTER:**

Setting the display filter.

### FLOW UNITS



Depending on the selected meter mode (mass flow meter or volume flow meter) the display says “SELECT MASS UNITS” or “SELECT VOLUME UNITS” and provides correspondingly only mass or volume units.

The meter mode can only be changed in the SETUP menu (see chapter 4.5.6.1)

The following units (volume or mass per time) can be selected:

**time-Unit**      **Description**

S	second
MIN	minute
H	hour
D	day

**Mass-Unit**      **Description**

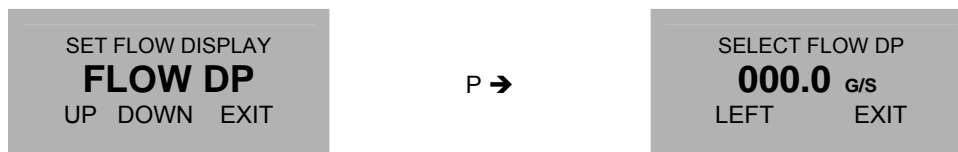
G	gram
KG	kilogram
LB	pound
OZ	dry ounce
T	metric ton
ST	stone

**Volume-Unit**      **Description**

CC	cubic centimeter
L	liter
m3	cubic meter
UGAL	US gallon
LOZ	fluid ounce
EGAL	English gallon
BBL	English barrel

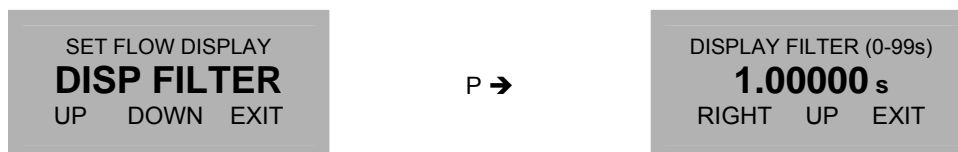
Use the keys “UP” and “DOWN” to select the engineering unit and confirm with “P” or skip with “EXIT”.

### FLOW DP



Use the key “LEFT” to select the desired decimal point position and confirm with “P” or skip with “E”.

### DISP FILTER



The time constant  $t$  is the time the displayed value needs after a jump from  $x$  to 0 to go to  $x/e = x/2.72$ .

**NOTE:**

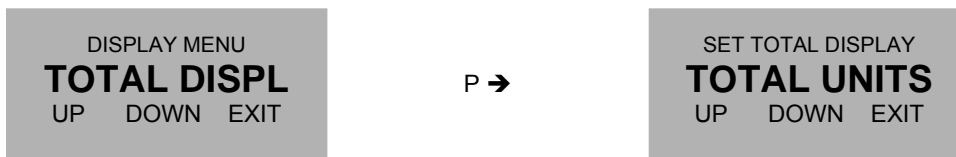
The display filter only filters the value in the display for providing a more stable reading. It has no influence on the outputs.

As the display filter is additional to the global filter, the display can never react faster than the outputs.

Use the keys "RIGHT" and "UP" to select the desired time constant and confirm with "P" or skip with "EXIT".

**4.5.4.2 TOTAL DISP menu**

In the submenu "TOTAL DISPL" the total and batch dimensions and decimal point can be set.



Use the keys "UP" and "DOWN" to select the desired submenu and confirm with "P" or skip with "EXIT".

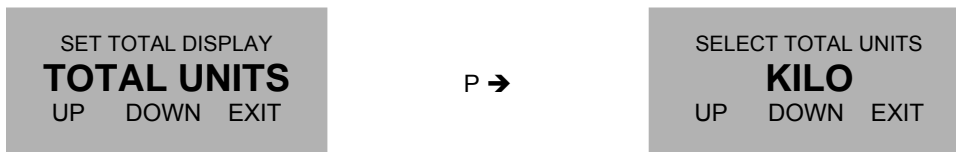
The following submenus are available:

**TOTAL UNITS:**

Setting the total units.

**TOTAL DP:**

Setting the total decimal point.

**TOTAL UNITS**

Depending on the selected meter mode (mass flow meter or volume flow meter) only mass or volume units can be selected.

The meter mode can only be changed in the SETUP menu (see chapter 4.5.6.1)

The following units can be selected:

**Mass-Unit      Description**

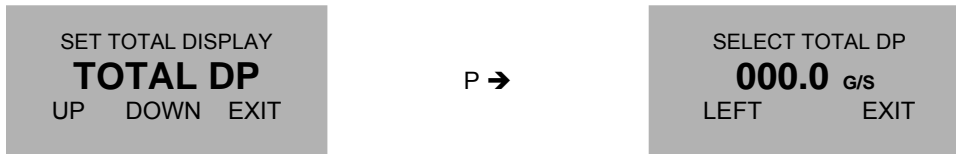
G	gram
KG	kilogram
LB	pound
OZ	dry ounce
T	metric ton
ST	stone

**Volume-Unit      Description**

CC	cubic centimeter
L	liter
m3	cubic meter
UGAL	US gallon
LOZ	fluid ounce
EGAL	English gallon
BBL	English barrel

Use the keys "UP" and "DOWN" to select the engineering unit and confirm with "P" or skip with "EXIT".

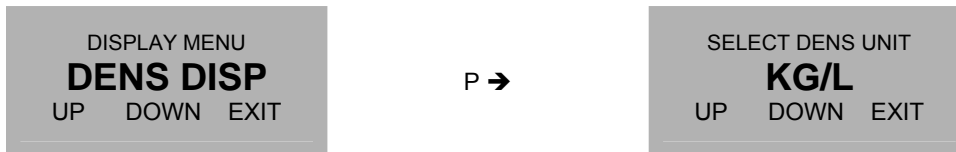
## TOTAL DP



Use the key “LEFT” to select the desired decimal point position and confirm with “P” or skip with “E”.

### 4.5.4.3 DENS DISPLAY menu

In the submenu “DENS DISPLAY” the density dimension can be set.



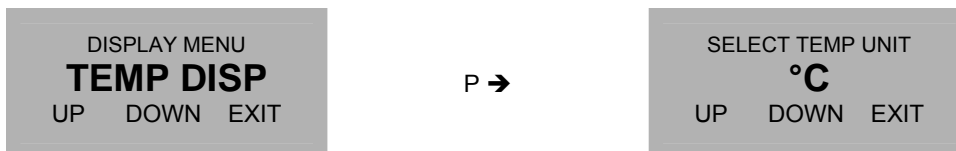
The following units (mass per volume) can be selected:

<u>Unit</u>	<u>Description</u>
G/CC	gram per cubic centimeter
G/L	gram per liter
KG/L	kilogram per liter
LB/FT3	pound per cubic feet
LB/GAL	pound per US gallon
KG/M3	kilogram per cubic meter
BRIX	Brix

Use the keys “UP” and “DOWN” to select the engineering unit and confirm with “P” or skip with “EXIT”.

### 4.5.4.4 TEMP DISP menu

In the submenu “TEMP DISP” the temperature engineering unit can be set.



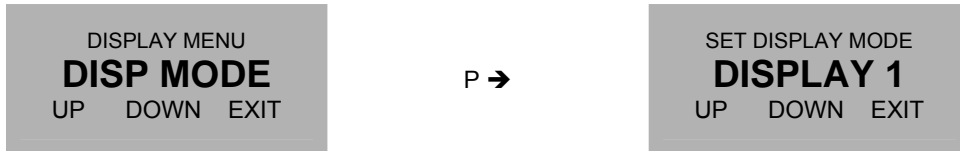
The following units can be selected:

<u>Unit</u>	<u>Description</u>
°C	Centigrade
°F	Fahrenheit
KELVIN	Kelvin

Use the keys “UP” and “DOWN” to select the engineering unit and confirm with “P” or skip with “EXIT”.

#### 4.5.4.5 DISP MODE menu

In the submenu "DISP MODE" the display mode can be set.



Use the keys "UP" and "DOWN" to select the desired submenu and confirm with "P" or skip with "EXIT".

The following submenus are available:

**DISPLAY 1:**

Setting the content of display 1.

**DISPLAY 2:**

Setting the content of display 2.

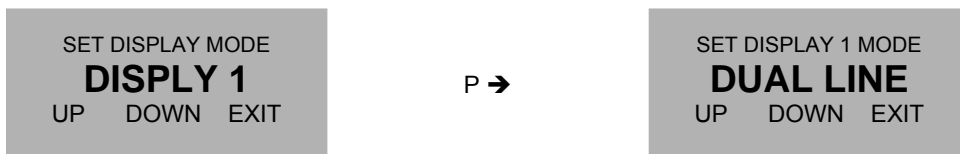
**BACKLIGHT:**

Switching on and off the backlight.

**TIME MODE:**

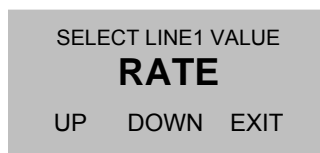
Setting fixed or alternating display.

**DISPLAY 1**



Use the keys "UP" and "DOWN" to select dual line or single line and confirm with "P" or skip with "EXIT".

The display shows



The following values can be selected:

<u>Unit</u>	<u>Description</u>
RATE	Actual flow
BATCH	Batch count
DENS:	Density
TEMP.	Temperature
TOTAL	Total count
F-OUT	Actual frequency at the frequency output
CURR-1	Actual currant at the analog output 1
CURR-2	Actual currant at the analog output 2

Use the keys "UP" and "DOWN" to select the desired value and confirm with "P" or skip with "EXIT".

The display shows



Use the keys "UP" and "DOWN" to select the desired value and confirm with "P" or skip with "EXIT".

The unit returns to the display mode menu.

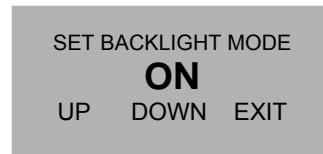
### DISPLAY 2

See DISPLAY 1

### BACKLIGHT



P →



Use the keys "UP" and "DOWN" to switch on or off the backlight and confirm with "P" or skip with "EXIT".

### TIME MODE



P →



In the fixed mode the display shows constantly the defined display 1 or 2. With the pushbutton "Display" it is possible to switch over between display 1 or 2.

In the alternate mode the display switches over every 7 seconds between display 1 and 2.

Use the keys "UP" and "DOWN" to select the desired mode and confirm with "P" or skip with "EXIT".

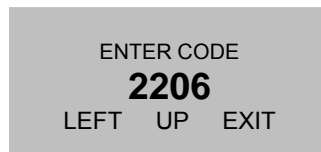
## 4.5.5 SETUP Menu

In the SETUP menu all settings can be made to adapt the meter to the individual requirements.

Select in the main menu



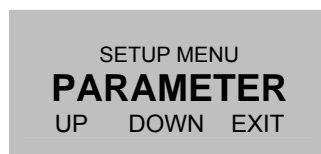
Press "P". The display shows



Change the indicated number with "LEFT" and "UP" to 2207 and confirm with "P".

If a wrong code is entered, the display shows "ERROR" for about 2s and then asks for a new input.

When the correct code is entered the display shows:



The following submenus are available:

### PARAMETER:

METER MODE	Selecting mass or volume meter mode
FLOW FILTER	Setting the filter time constant
CUT OFF	Setting the cutoff value
STEP RESP:	Adjusting the settings for fast changing flow
RESET KEY	Enable / disable the key "Reset"
FLOW-DIREC	Setting up the unit for reverse flow
K-FACTOR	Fine scaling the meter
FAULT TIME	Setting the error response time
LANGUAGE	Selecting the display language

### IN/OUTPUTS:

FREQ OUT	Configuring the frequency output
CTRL OUT	Configuring the control output
ANALOG OUT	Configuring the analog output
CTRL IN	Configuring the control input
INTERFACE	Configuring the interface

### DATA CONFIG:

SAVE DATA	Saving the actual settings as backup
RECALL DATA	recalling the last settings from the backup

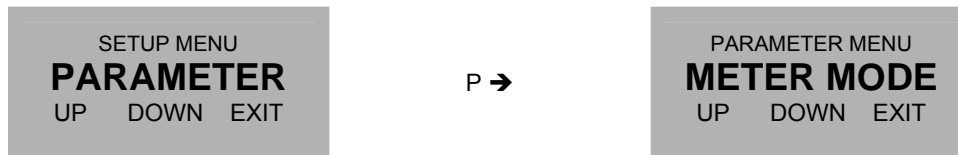
### RESET TOTAL:

Resets the total count to zero.

Use the keys "UP" and "DOWN" to select the desired submenu and confirm with "P" or skip with "E".

### 4.5.6 SETUP PARAMETER menu

In the submenu SETUP / PARAMETER all user settable internal parameter can be set for adjusting the unit for a given application.

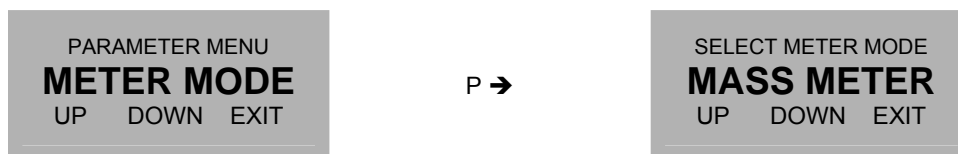


Use the keys “UP” and “DOWN” to select the desired submenu and confirm with “P” or skip with “E”.

#### 4.5.6.1 METER MODE menu

In the submenu “METER MODE” can be set, if the flow meter shall be used as a mass flow meter or a volume flow meter.

If “mass flow meter” is selected, no volume units can be displayed and vice versa.



Use the keys “UP” and “DOWN” to select the desired submenu and confirm with “P” or skip with “E”.

If the mode is changed, the display shows:



Then the following message scrolls through the display:

WARNING! CHANGING THE METER MODE WILL RESET ALL UNITS AND THE TOTAL COUNTER. DO YOU WANT TO PROCEED?

Confirm with “YES” or skip with “NO”.

The display returns to the setup parameter menu.

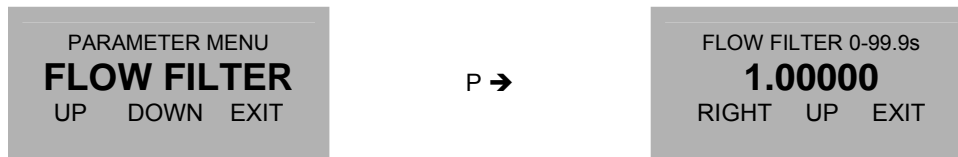
#### 4.5.6.2 FLOW-FILTER menu

In the submenu “FLOW-FILTER” the time constant for the flow filter can be set.

The time constant is the time the output needs after a jump from  $x$  to 0 to go to  $x/e = x/2.72$ .

A rough relation between the time and the filtered flow value after a jump is

Elapsed time	Remaining error (% of the step)
1 * t	30
2 * t	10
3 * t	3
4 * t	1

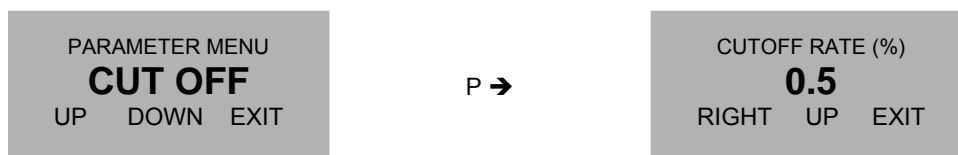


Use the keys “RIGHT” and “UP” to select the desired value and confirm with “P” or skip with “EXIT”.  
The display returns to the setup parameter menu.

#### 4.5.6.3 CUT OFF menu

In the submenu “CUT-OFF” the cutoff in percent of the full scale flow range can be set.

If the absolute value of the measured and filtered flow is below the cutoff value, the calculated flow is “0” and consequently all outputs show zero flow and the total and batch value remain unchanged.



Use the keys “RIGHT” and “UP” to select the desired value and confirm with “P” or skip with “EXIT”.  
The display returns to the setup parameter menu.

#### 4.5.6.4 RESP STEP menu

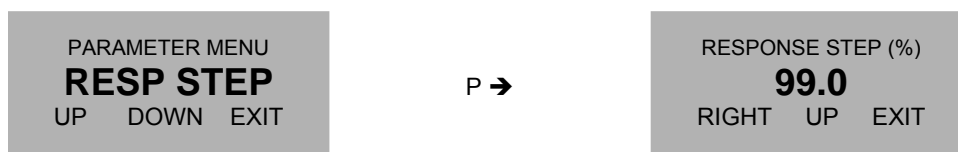
In the submenu “RESP STEP” the reaction to fast changing flows can be set.

If the difference between the measured flow and the filtered flow is smaller than the step response value, the flow filter remains active. If the difference is higher than step response, the filter is cleared and filled with the new value.

The recommended value for constant or slowly changing flow is 99% (the default value ex work). If the unit has to react to fast changing flow, the optimum value depends on the individual situation. For ON / OFF operation a value of half the ON flow is recommended, if this is less than the default 10%.

#### NOTE:

A too low value will lead to noisy measurement whereas a too high value with fast changing flow (ON /OFF operation) will lead to a too slow reaction of the meter.

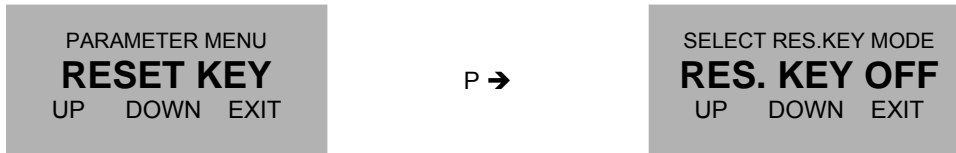


Use the keys “RIGHT” and “UP” to select the desired value and confirm with “P” or skip with “EXIT”.  
The display returns to the setup parameter menu.

#### 4.5.6.5 RESET KEY menu

In the submenu "RESET-KEY" the pushbutton "Reset" can be enabled or disabled.

If the pushbutton Reset is active, it can be used to reset the batch counter.



Use the keys "UP" and "DOWN" to enable or disable the key and confirm with "P" or skip with "EXIT".

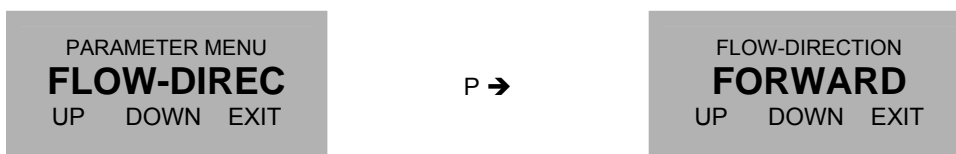
The display returns to the setup menu

#### 4.5.6.6 FLOW DIRECTION menu

In the submenu "FLOW-DIREC" the positive direction of the flow can be set.

If flow direction is "forward" (default setting), a flow through the meter in direction of the arrow on the meter will be displayed positive, the opposite flow negative.

If for technical reasons the meter must be mounted in that way, that the normal flow is against the direction of the arrow, the sign of the flow can be inverted by setting flow direction to "reverse".



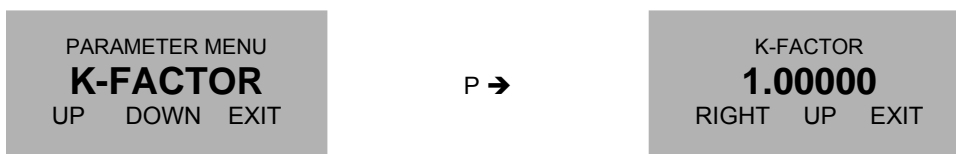
Use the keys "UP" and "DOWN" to select the positive flow direction and confirm with "P" or skip with "EXIT".

The display returns to the setup menu

#### 4.5.6.7 K-FACTOR menu

In the submenu "K-FACTOR" the k- factor for fine tuning of the flow calculation can be set.

Ex work the unit is calibrated with a k- factor of "1". If for any reasons the flow measured by the mass flow meter differs slightly from a flow measured with other means, the value calculated by the KCM8000 can be adjusted by changing the k- factor.



Use the keys "RIGHT" and "UP" to select the desired value and confirm with "P" or skip with "EXIT".

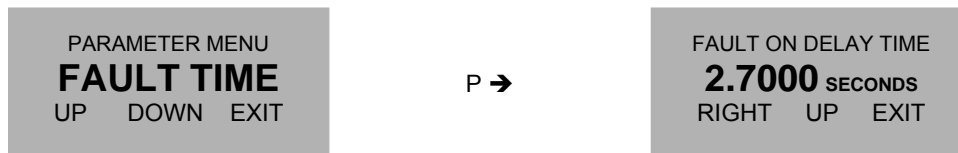
The display returns to the setup parameter menu.

#### 4.5.6.8 FAULT TIME menu

In the submenu "FAULT TIME" the reaction time of the KCE8000 in case of an error can be defined.

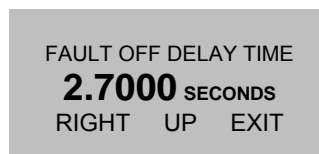
The fault on delay time is the time an error must be present, until the red LED lights up and the error output signal is activated.

The fault off delay time is the time an error signal persists on the red LED and on the control output, after the error disappeared.



Use the keys "LEFT" and "UP" to select the desired value and confirm with "P" or skip with "E".

The display shows



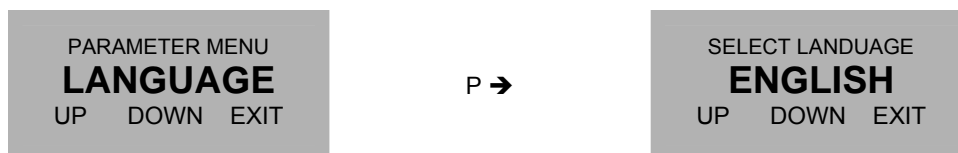
Use the keys "LEFT" and "UP" to select the desired value and confirm with "P" or skip with "E".

The display returns to the setup menu.

#### 4.5.6.9 LANGUAGE menu

In the submenu "LANGUAGE" the language used in the display can be selected.

At the time being English and Russian can be selected. If Russian is selected, only the main menu is in Russian language, the control menu remains in English.



Use the keys "UP" and "DOWN" to select the language and confirm with "P" or skip with "E".

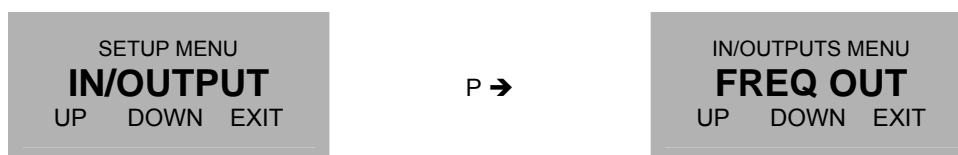
The display returns to the setup menu.

In case you cannot read the display the menu can be accessed by:

3s P/Display/Display/P/Display/P/P/Reset/P

#### 4.5.7 SETUP IN/OUTPUTS menu

In the submenu SETUP / IN/OUTPUTS the input and output ports of the KCE8000 can be configured.



Use the keys "UP" and "DOWN" to select the desired submenu and confirm with "P" or skip with "E".

#### 4.5.7.1 FREQ OUT menu

In the submenu "FREQ OUT" the frequency output can be configured.

The frequency output has 2 operating modes:

##### FREQUENCY:

A frequency proportional to the actual flow is generated.

If a negative flow must be given out as well, the control output can be used as sign.

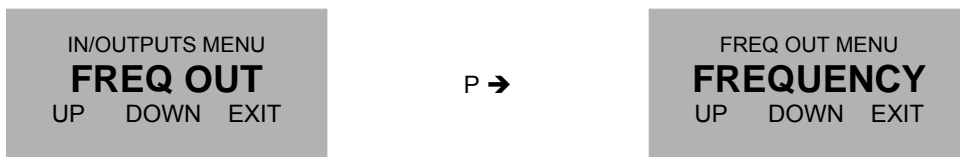
Frequencies between 2Hz and 10kHz can be generated in this mode.

##### TOTAL COUNT:

Each time the total increments by the selected total increment step, the output produces a pulse. For having a 50% duty cycle, the output changes its state each time after half the increment step.

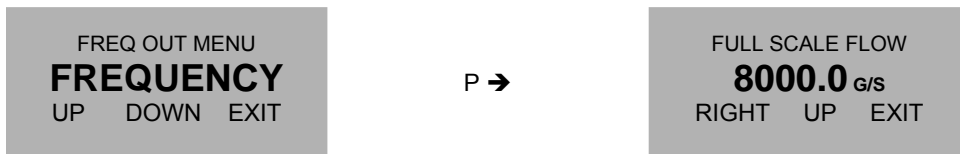
If the flow is negative in between, no pulses are generated until the following positive flow compensates for the negative flow in between. Thus the medium will not be counted twice, if in between a flow backwards occur.

The maximum output frequency which can be generated in this mode is about 50Hz.



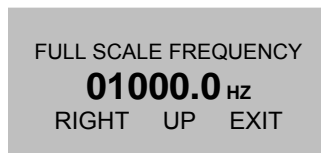
Use the keys "UP" and "DOWN" to select the desired mode and confirm with "P" or skip with "E".

##### FREQUENCY



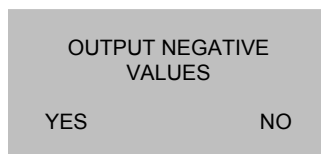
Use the keys "RIGHT" and "UP" to select the desired full scale value and confirm with "P" or skip with "EXIT".

The display shows

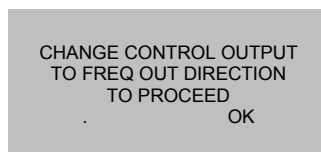


Use the keys "RIGHT" and "UP" to select the desired frequency and confirm with "P" or skip with "EXIT".

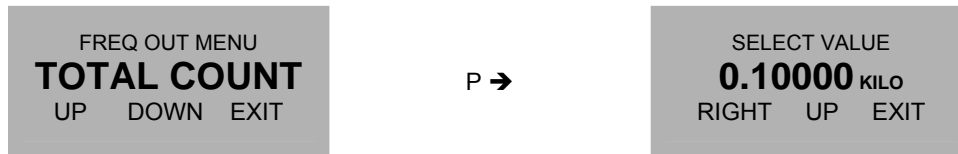
The display shows



If "YES" is selected and the control output is not configured as sign output, the display shows



Confirm with "OK" and configure the control output correspondingly if required.

**TOTAL COUNT**

Use the keys “RIGHT” and “UP” to select the desired increment step and confirm with “P” or skip with “EXIT”.

**4.5.7.2 CONTROL OUT menu**

In the submenu “CTRL OUT” the control output can be configured.

The control output has 3 operating modes:

**BATCH:**

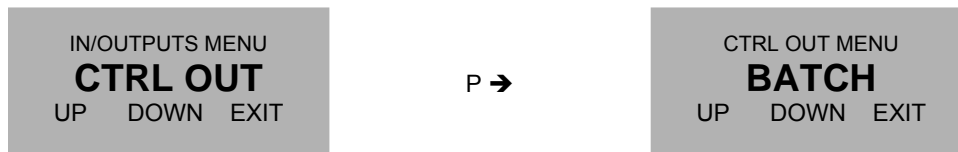
In the batch mode the KCE8000 operates as a batch counter. If the preset batch value is reached, the control output goes to the active state. With an active signal at the control input the batch counter can be reset to zero. For this mode the control input must be configured as “reset batch”.

**FAULT:**

In case of an error the control output goes high. For setting the on and off delay time refer to chapter 4.5.6.8.

**FLOW DIREC:**

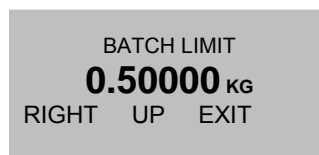
The control output is low, if a positive flow is measured, and high, if a negative flow is measured.



Use the keys “UP” and “DOWN” to select the desired mode and confirm with “P” or skip with “E”.

If FAULT or FLOW DIREC was selected, the KCE changes the settings and returns to the IN/OUTPUT menu.

If BATCH was selected, the display shows



Use the keys “RIGHT” and “UP” to select the desired batch value and confirm with “P” or skip with “EXIT”.

The display shows



Use the keys “UP” and “DOWN” to select the desired value and confirm with “P” or skip with “E”.

### 4.5.7.3 ANALOG OUT menu

In the submenu "ANALOG OUT" the 4 – 20mA outputs can be configured.

Each analog output can show one of the following 4 parameters:

FLOW:

The output current is proportional to the actual flow.

DENSITY:

The output current is proportional to the actual density.

TEMPERATURE:

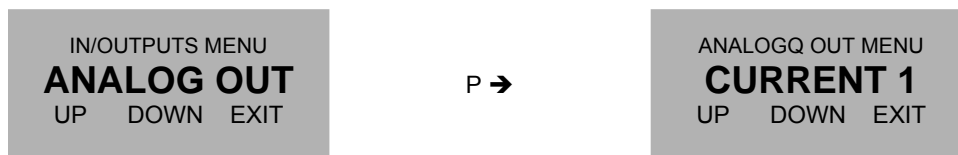
The output current is proportional to the actual temperature.

BATCH COUNT:

The output current is proportional to the actual batch value.

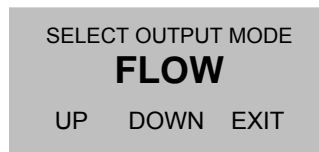
This mode is only possible, if the control input is configured as "RESET BATCH"

The value for 4mA as well as the value for 20mA can be freely selected. Thus it is possible to zoom in (e.g. temperatures from 20°C to 30°C) or to show negative values as well (e.g. flow from -10kg/min to +20kg/min).



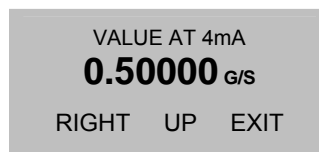
Use the keys "UP" and "DOWN" to select the desired output channel and confirm with "P" or skip with "E".

The display shows



Use the keys "UP" and "DOWN" to select the desired output value and confirm with "P" or skip with "E".

The display shows



The indicated engineering unit depends on the selected output value and the display setup.

Use the keys "RIGHT" and "UP" to select the desired value for 4 mA and confirm with "P" or skip with "EXIT".

The display shows



Use the keys "RIGHT" and "UP" to select the desired value for 20 mA and confirm with "P" or skip with "EXIT".

The display returns to the IN/OUTPUT menu.

#### 4.5.7.4 CONTROL IN menu

In the submenu "CTRL IN" the control input can be configured.

The control output has 2 operating modes:

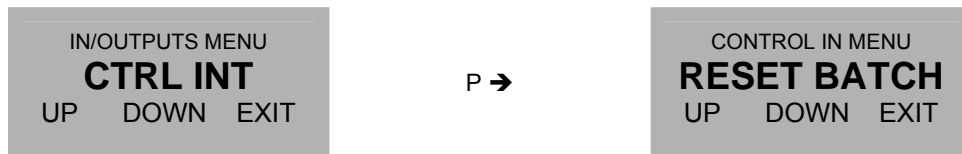
RESET BATCH:

If a high level is applied to the input, the batch counter is reset to 0.

This mode must be selected, if the control output is to be used as a batch output and / or if one of the analog outputs is to be used as batch output

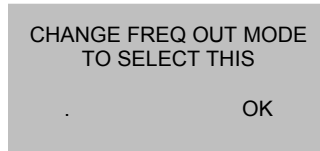
EXTERNAL ZERO:

If a high level is applied to the input, the KCE8000 starts the zero offset procedure.



Use the keys "UP" and "DOWN" to select the desired mode and confirm with "P" or skip with "E".

If "EXT: ZERO" is selected and one of the outputs is set to batch output, the display shows



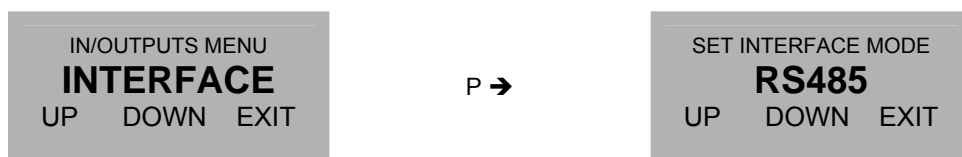
Confirm with "OK" and configure the output correspondingly if required.

#### 4.5.7.5 INTERFACE menu

In the submenu "INTERFACE" the interface can be configured.

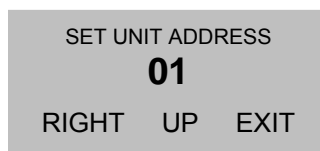
Depending on the configuration one or more of the following interfaces can be selected:

RS485  
HART  
Foundation Fieldbus



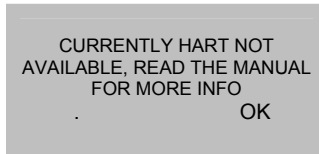
Use the keys "UP" and "DOWN" to select the desired mode and confirm with "P" or skip with "E".

If "RS485" is selected, the display shows:



Use the keys "RIGHT" and "UP" to select the desired address and confirm with "P" or skip with "EXIT".

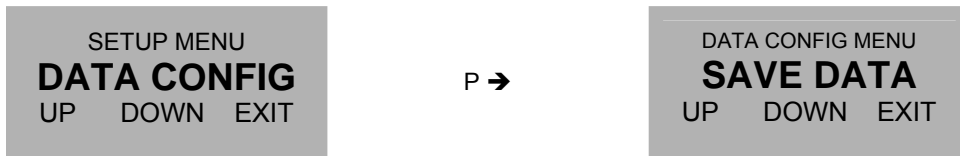
If an interface not implemented is selected, the display shows



Confirm with "OK" and select an implemented interface.

#### 4.5.8 SETUP DATA CONFIGURATION menu

In the submenu SETUP / DATA CONFIG the current setting can be stored to the backup memory and the stored settings can be recalled

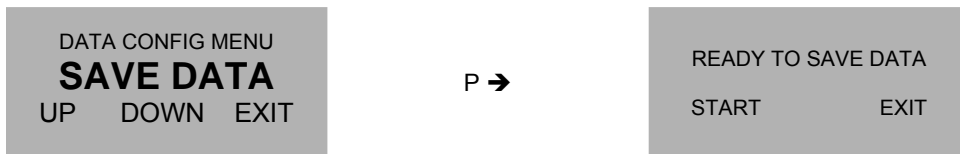


Use the keys "UP" and "DOWN" to select the desired submenu and confirm with "P" or skip with "E".

##### 4.5.8.1 SAVE DATA menu

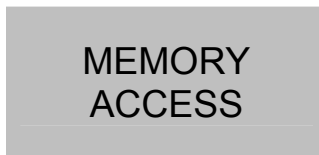
In the submenu "SAVE DATA" the current settings can be stored in the backup memory.

At each power on the KCE8000 compares the content of the setup memory and the backup memory. If the data in those 2 memories are different, the KCE8000 gives out a warning. For avoiding that warning it is recommended to make a backup as soon as the new settings are proven to be okay.



Start the backup process with "START" or skip with "EXIT".

If "START" is pressed, the display shows for some seconds



After that for about 2 seconds



The display returns to the DATA CONFIG menu.

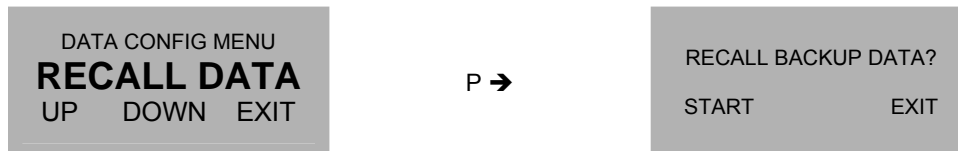
#### 4.5.8.2 RECALL DATA menu

In the submenu "RECALL DATA" the old settings are reloaded from the backup memory.

Reloading the old settings is recommended if after bigger changes in the setup the unit does not work properly any more.

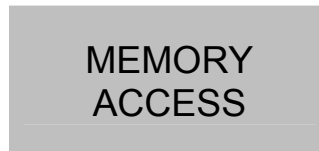
**NOTE:**

Backup data overwritten with "SAVE DATA" cannot be restored!

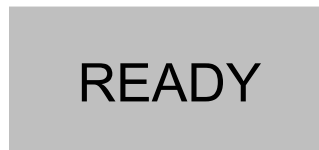


Start the recall process with "START" or skip with "EXIT".

If "START" is pressed, the display shows for some seconds



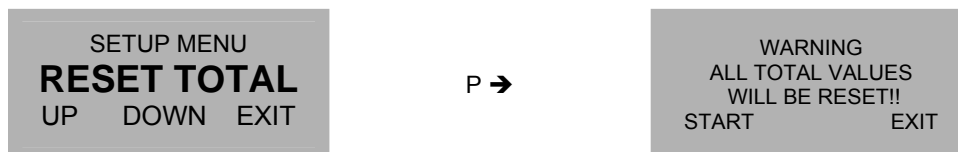
After that for about 2 seconds



The display returns to the DATA CONFIG menu.

#### 4.5.9 SETUP RESET TOTAL menu

In the submenu SETUP / RESET TOTAL the total counter can be reset to zero



Reset the total with "START" or skip with "EXIT".

The display returns to the RESET TOTAL menu.

### 4.5.10 I/O-TEST Menu

In the I/O-TEST menu all inputs and outputs can be tested.

Select in the main menu

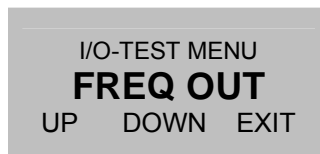


Press "P". The display shows



Change the indicated number with "LEFT" and "UP" to 2207 and confirm with "P".  
If a wrong code is entered, the display shows "ERROR" for about 2s and then asks for a new input.

When the correct code is entered the display shows:



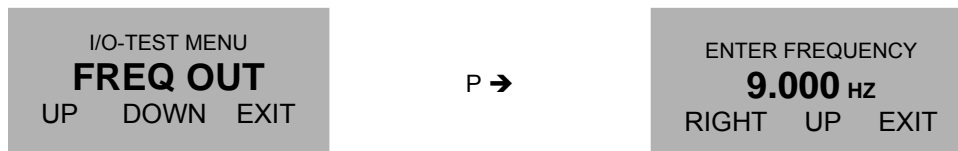
The following submenus are available:

- |            |  |
|------------|--|
| FREQ OUT   | A freely settable frequency can be applied to the output |
| CTRL OUT   | The output level can be set                              |
| ANALOG OUT | A freely settable current can be applied to the outputs  |
| CTRL IN:   | The actual level at the input is indicated               |

When the I/O-TEST menu is left, all outputs return to normal operation.

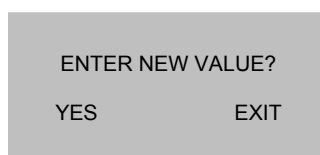
#### 4.5.10.1 FREQ OUT menu

In the submenu "FREQ OUT" a freely settable frequency between 1Hz and 9999Hz can be applied to the output.



Use the keys "RIGHT" and "UP" to select the desired value and confirm with "P" or skip with "EXIT".

If "P" was pressed the frequency is applied to the output and the display shows

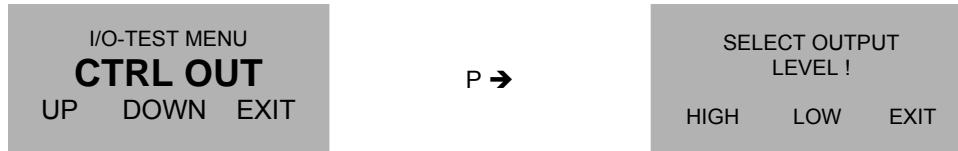


Press "YES" to enter a new value or "EXIT" to leave the menu.

If "EXIT" is pressed, the display returns to the I/O-TEST menu.

#### 4.5.10.2 CTRL OUT menu

In the submenu "CTRL OUT" a low or high level can be applied to the output.

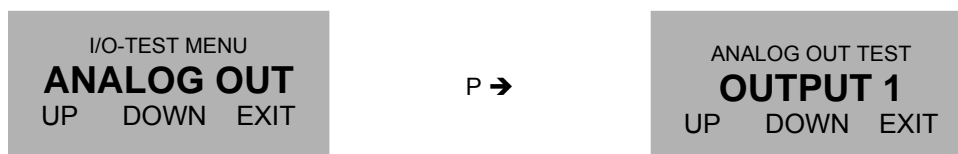


Use the keys "HIGH" and "LOW" to set the output value or leave the menu with "EXIT".

If "EXIT" is pressed, the display returns to the I/O-TEST menu.

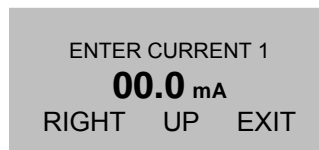
#### 4.5.10.3 ANALOG OUT menu

In the submenu "ANALOG OUT" a freely settable current between 2mA and 21mA can be applied to the output.



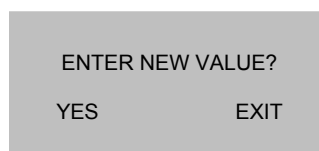
Use the keys "UP" and "DOWN" to select the desired output and confirm with "P" or skip with "E".

The display shows



Use the keys "RIGHT" and "UP" to select the desired value and confirm with "P" or skip with "EXIT".

If "P" was pressed the current is applied to the output and the display shows

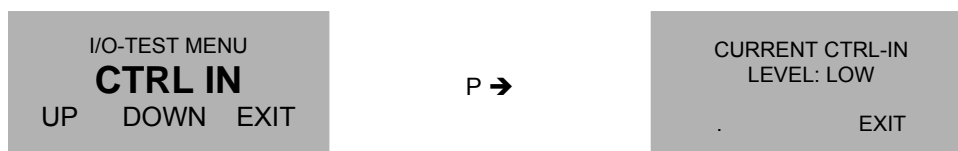


Press "YES" to enter a new value or "EXIT" to leave the menu.

If "EXIT" is pressed, the display returns to the I/O-TEST menu.

#### 4.5.10.4 CTRL IN menu

In the submenu "CTRL IN" the display shows level currently applied to the control input.



The display does not show the actual level at the input, but the level at the moment, when the CTRL IN menu was entered.

After evaluating the input press "EXIT" to return to the I/O-TEST menu.

### **4.5.11 SERVICE Menu**

The “SERVICE” menu is used to calibrate the meter and to recall the original factory settings.

For a description of the menu refer to chapter 6.4.

## 5 Remote operation

As a standard the KCE8000 is equipped with an RS-485 Interface. Optionally also a HART or Foundation Fieldbus interface is available.

### 5.1 RS485

#### 5.1.1 Electrical connection of RS-485

Prepare the KCE8000 and the cable as described in chapter 0 or 3.2.3.

Connect the signal RS-485A or RS-485+ (both names are used in the literature) to terminal 22 and RS-485- or RS-485B to terminal 21.

Terminal 20 is the ground reference pin for the interface and is connected to terminal 8 and to the supply ground of the DC supply (terminal 52)

**NOTE:**

The operating range of the data terminals (21 and 22) is -7V to +12V referred to ground (52). Voltages outside that range could damage the KCE8000.

#### 5.1.2 Ex installation of RS485

The RS-485 terminals are designed for an operating voltage of -7V to +12V and a rated voltage of 30V AC.

For connecting the interface refer to chapter 5.1.1 and 3.3.

**NOTE:**

The operating range of the data terminals (21 and 22) is -7V to +12V referred to ground (52). Voltages outside that range could damage the KCE8000.

---

**WARNING!**

Applying more than 30V DC to any of the RS-485 terminals will damage the KCE and destroy the protection of the KCM!

---

**WARNING!**

If more than 30V have been applied to any of the RS-485 terminals, the unit must be returned to KEM for repair as the safety barrier might be destroyed!

---

#### 5.1.3 RS485 Interface Protocol

The KCE8000 uses a proprietary KEM communication protocol.

The parameters for the serial communication are:

19200 bit/s  
8 data bit  
no parity bit  
1 stop bit

For setting up a communication refer to the command list available from KEM.

## 5.2 HART

### 5.2.1 Electrical connection for HART

For the HART communication the current output CURRENT 1 is used.

Connect the analog output CURRENT 1 as described in chapter 3.2.6 and connect the HART communicator in series to the analog output of the KCE.

Refer to the manual of your HART communicator for the proper connection.

### 5.2.2 Ex installation for HART

The analogue current output terminals are designed for a rated voltage of 30V AC.

The outputs are protected against wrong polarity. Voltages below 30V will not damage the outputs nor affect the Ex safety.

Refer to chapter 3.3.7

---

#### **WARNING!**

Applying more than 30V DC to the analog output terminals will damage the KCE and destroy the protection of the KCM!

---

---

#### **WARNING!**

If more than 30V have been applied to any of the analog output terminals, the unit must be returned to KEM for repair as the safety barrier might be destroyed!

---

### 5.2.3 HART Interface Protocol

For getting the newest DD file contact KEM.

## 5.3 Foundation Fieldbus

### 5.3.1 Electrical connection of Foundation Fieldbus

Prepare the KCE8000 and the cable as described in chapter 0 or 3.2.3.

Connect the signal FF+ (positive rail of the bus) to terminal 32 and FF- (negative rail of the bus) to terminal 31.

Terminal 20 is the ground reference pin for the interface and is connected to terminal 8 and to the supply ground of the DC supply (terminal 52)

### 5.3.2 Ex installation of Foundation Fieldbus

The FF terminals are designed for a rated voltage of 30V AC.

For connecting the interface refer to chapter 5.3.1 and 3.3.

---

**WARNING!**

Applying more than 30V DC to any of the FF terminals will damage the KCE and destroy the protection of the KCM!

---

---

**WARNING!**

If more than 30V have been applied to any of the FF terminals, the unit must be returned to KEM for repair as the safety barrier might be destroyed!

---

### 5.3.3 FF Interface Protocol

For getting the newest DD file contact KEM.

## 6 Service and Maintenance

### 6.1 Maintenance

The sensors of the KCM series as well as the electronics of the KCE8000 series do not require regular maintenance.

In case of abrasive or sedimenting media however it is recommended to return the measuring system to KEM after 8,000 hours of operation for re-calibration and pressure test. This interval may be shorter when the medium is extremely abrasive or sedimenting.

For best performance we recommend checking the calibration every 5 years, in harsh environments even more frequent.

If for the specific application an obligatory calibration is required, refer to the corresponding national regulations for the necessary calibration intervals.

### 6.2 Trouble shooting

In case the C-Flow does not work properly, first check the following items:

#### **No display, no LED lighting**

All cables properly connected?

→ Connect the missing cables

Power supply switched on?

→ Switch on the power supply

Display positioned properly (compact and wall mount only)?

→ Remove the display and reset it properly

Internal fuse of the KCE blown?

→ For checking and changing the fuses refer to chapter 6.3.

#### **Output frequency too high or unstable**

Most probably EMC problems

Shield and ground properly connected?

→ Connect shield properly. If necessary, try additional means of grounding and shielding

#### **Unstable flow reading with (theoretically) stable flow**

Gas bubbles or solid particles in the medium?

→ Mount the meter with the correct orientation

Strong external vibrations?

→ Decouple the meter from the vibration source

Flow or pressure slugs in the medium?

→ Decouple the meter hydraulically

#### **No frequency or current output with operating display**

Output correctly wired?

→ Correct the wiring

Output correctly configured?

→ Correct the configuration

Wrong flow direction (Flow in the display is negative)?

→ Change flow direction

## 6.3 Changing the fuses

The power supply inputs of the TCE8000 contain fuses.

With the non-Ex versions the fuses can easily be replaced by qualified personnel.

### 6.3.1 Changing the fuse with the KCE80\*\*-WG-\*-\*\* and compact version

Switch off the power supply.

Open the safety screw at the display cover of the unit with the provided Allen key.

Remove the display cover of the KCE by turning it counter clockwise.

Pull out the display

Remove the 3 screws in the PCB and pull it out carefully.

Below the ribbon cable connector you find the following fuse in the fuse holder:

Littelfuse NANO 2 375mA slow blow, ordering code 0452.375

#### **NOTE**

For your own safety replace the fuse only by the same type and rating.

Replace the fuse and reclose the unit.

### 6.3.2 Changing the fuse with the KCE80\*\*-SG-\*

Switch off the power supply.

Remove the 4 screws in the back panel and pull out the back panel carefully.

Below the ribbon cable connector you find the following fuse in the fuse holder:

Littelfuse NANO 2 375mA slow blow, ordering code 0452.375

#### **NOTE**

For your own safety replace the fuse only by the same type and rating.

Replace the fuse and reclose the unit.

### 6.3.3 Changing the fuse with the Ex versions

With the Ex versions the fuses are part of the safety barriers and must only be exchanged by KEM or by personnel authorized by KEM.

In case one of the fuses has blown, contact KEM or your nearest dealer.

---

#### **WARNING!**

The Ex versions of the KCE8000 series contain several internal fuses for protecting the intrinsically safe TCM against too high voltage and power. Those fuses are critical parts and must not be exchanged except by KEM or by service personnel authorized by KEM. If the fuses are replaced by third persons, the Ex certification for the unit will be void!

---

## 6.4 Calibration

In the calibration menu the flow, density and temperature measurement of the KCE8000 can be calibrated.

Press “P” for about 3 seconds

The display shows:

```
MAIN MENU
ZERO OFFSET
UP  DOWN  EXIT
```

Use the key “UP” or “DOWN” to select

```
MAIN MENU
SERVICE
UP  DOWN  EXIT
```

Press “P”. The display shows

```
ENTER CODE
2206
LEFT  UP  EXIT
```

Change the indicated number with “LEFT” and “UP” to 2208 and confirm with “P”.

If a wrong code is entered, the display shows “ERROR” for about 2s and then asks for a new input.

When the correct code is entered the display shows:

```
SERVICE MENU
CALIBRATION
UP  DOWN  EXIT
```

Press “P”. The display shows

```
CALIBRATION MENU
METER VAR.
UP  DOWN  EXIT
```

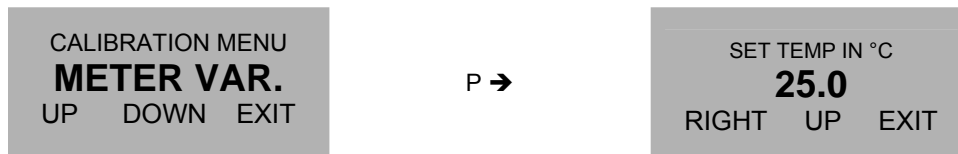
The following submenus are available:

TEMP CALIB.	Calibrating the temperature measurement
AIR CALIB.	Calibrating the density measurement at low density
WATER CALIB.	Calibrating the density measurement at high density
METER VAR.	Calibrating the flow measurement

### 6.4.1.1 Temperature Calibration

For calibrating the temperature reading of the KCE8000, the medium temperature must be well known.

Before starting the calibration make sure that the temperature reading has been stable for several minutes for making sure that the medium temperature and the temperature sensor temperature are the same.



Use the keys “RIGHT” and “UP” to set the actual medium temperature and confirm with “P” or skip with “E”.

The display returns to the CALIBRATION menu.

### 6.4.1.2 Air Density Calibration

#### NOTE

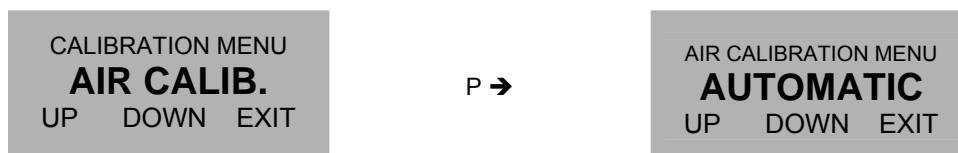
Make sure that the temperature reading is calibrated before starting the air calibration.

The low end calibration of the density measurement is normally done with empty tubes (filled with air).

In the automatic mode the unit performs an automatic calibration, assuming that the tubes are filled with normal air.

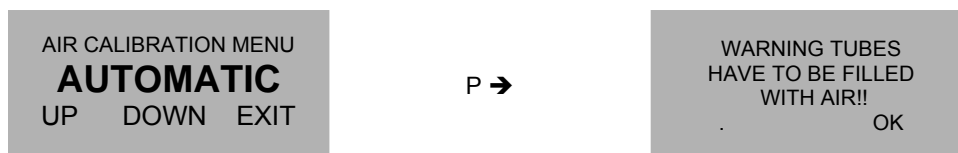
In the manual mode the three parameters temperature, tube frequency and reference density can be altered individually. This is necessary if the air calibration is performed with a gas with a density different than air. In that case make first the automatic calibration and then override in the manual calibration the density value by the density of the medium used for calibration.

Before starting an automatic calibration, make sure that the KCM is completely empty as any drop of a liquid inside will spoil the calibration result.



Use the keys “UP” and “DOWN” to select the mode and confirm with “P” or skip with “EXIT”.

#### AUTOMATIC mode



Confirm with “OK”. The display shows

DO YOU WANT TO  
PROCEED CALIBRATION?  
YES NO

Start the calibration with "YES" or skip with "NO".

When "YES" was pressed, the display shows

AIR-TEMP: 23.0°C  
FREQUENCY: 141.5 Hz  
DENSITY: 1.4 G/L  
. OK

Confirm with "OK". The display returns to the AIR CALIBRATION menu.

### MANUAL MODE

AIR CALIBRATION MENU  
**MANUAL**  
UP DOWN EXIT

P →

ENTER AIR TEMP:  
**23.0 °C**  
RIGHT UP EXIT

Use the keys "RIGHT" and "UP" to set the reference temperature and confirm with "P" or skip with "EXIT". The display shows

ENTER AIR FREQ:  
**141.52 Hz**  
RIGHT UP EXIT

This value must only be altered, if you have the data from a calibration sheet of the KCM. Skip with "EXIT". The display shows

ENTER AIR DENSITY:  
**1.407 G/L**  
RIGHT UP EXIT

Use the keys "RIGHT" and "UP" to set the reference density and confirm with "P" or skip with "EXIT".

The display returns to the AIR CALIBRATION menu.

### 6.4.1.3 Water Density Calibration

#### NOTE

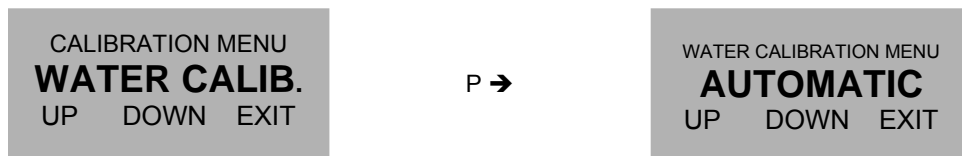
Make sure that the temperature reading is calibrated before starting the water calibration.

The high end calibration of the density measurement is normally done with tubes filled with water, but any other liquid with well-known density can be used as well.

In the automatic mode the unit performs an automatic calibration, assuming that the tubes are filled with water.

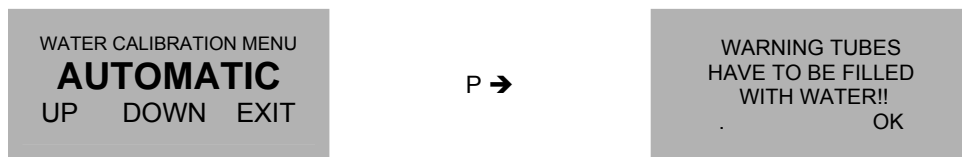
In the manual mode the three parameters temperature, tube frequency and reference density can be altered individually. This is necessary if the water calibration is performed with a liquid with a density different than water. In that case make first the automatic calibration and then override in the manual calibration the density value by the density of the medium used for calibration.

Before starting an automatic calibration, make sure that the KCM is completely filled with the test medium. Any pollution (air bubbles, solid particles or rests of other liquids) will spoil the calibration.

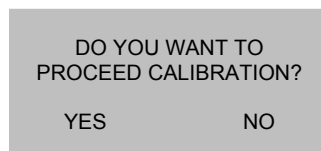


Use the keys “UP” and “DOWN” to select the mode and confirm with “P” or skip with “EXIT”.

#### AUTOMATIC mode

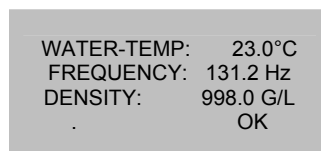


Confirm with “OK”. The display shows



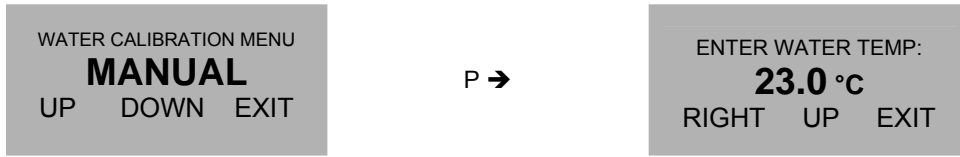
Start the calibration with “YES” or skip with “NO”

When “YES” was pressed, the display shows



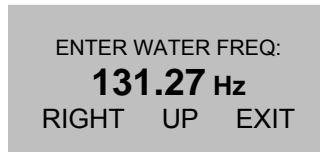
Confirm with “OK”. The display returns to the WATER CALIBRATION menu.

## MANUAL MODE

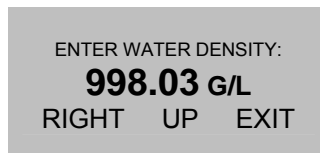


Use the keys "RIGHT" and "UP" to set the reference temperature and confirm with "P" or skip with "EXIT".

The display shows



This value must only be entered, if you have the data from a calibration sheet of the KCM. Skip with "EXIT". The display shows



Use the keys "RIGHT" and "UP" to set the reference density and confirm with "P" or skip with "EXIT".

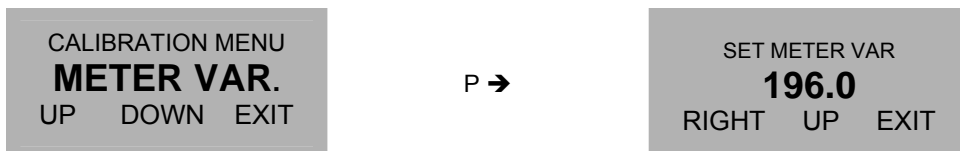
The display returns to the WATER CALIBRATION menu.

### 6.4.2 Flow Calibration

#### NOTE

Make sure that the temperature reading is calibrated before starting the flow calibration.

The flow can be calibrated by comparing the flow or batch reading of the KCE8000 to the reading of a more precise and calibrated reference meter.



The new meter variable can be calculated as:

$$\text{METER\_VAR}_{\text{new}} = \text{METER\_VAR}_{\text{old}} * \text{Reference\_reading} / \text{KCE8000\_reading}$$

Use the keys "RIGHT" and "UP" to set the calculated meter variable and confirm with "P" or skip with "EXIT".

The display returns to the CALIBRATION menu.

## 6.5 Service

The KCE8000 does not contain any user serviceable parts except the fuses.

In case of malfunction, please contact your nearest dealer or directly KEM.

For the addresses see chapter 7.7.

## 6.6 Reloading Factory Settings

In case the unit has been completely misadjusted for any reason, the unit can be reset to the original settings ex work.

Press "P" for about 3 seconds. The display shows:

```
MAIN MENU
ZERO OFFSET
UP  DOWN  EXIT
```

Use the key "UP" or "DOWN" to select

```
MAIN MENU
SERVICE
UP  DOWN  EXIT
```

Press "P". The display shows

```
ENTER CODE
2206
LEFT UP  EXIT
```

Change the indicated number with "LEFT" and "UP" to 2208 and confirm with "P".

If a wrong code is entered, the display shows "ERROR" for about 2s and then asks for a new input.

When the correct code is entered the display shows:

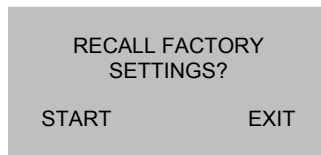
```
SERVICE MENU
CALIBRATION
UP  DOWN  EXIT
```

Use the key "UP" or "DOWN" to select RECALL FACT. The display shows:

```
SERVICE MENU
RECALL FACT
UP  DOWN  EXIT
```

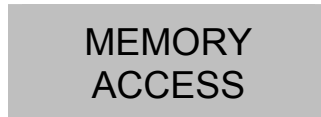
Select with "P" or skip with "EXIT".

The display shows.

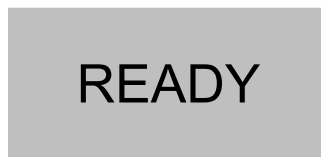


Start the recall process with "START" or skip with "EXIT".

If "START" is pressed, the display shows for some seconds



After that for about 2 seconds.



The display returns to the RECALL FACT menu.

## 7 Listings

### 7.1 Warranty

KEM warrants material and production for a period of 12 months after installation and start up, max. 18 months from delivery date.

### 7.2 Certifications and compliances

Category	Standards or description	
EC Declaration of Conformity - EMC	Meets intent of Directive 2004 / 108 / EEC for Electromagnetic Compatibility. Compliance is given to the following specifications as listed in the Official Journal of the European Communities:	
	EN 61326 / 2006	EMC requirements for Class A electrical equipment for measurement, control and laboratory use, including Class A radiated and Conducted Emissions <sup>1</sup> and Immunity <sup>1</sup> .
	IEC 61000-4-2 / 2009	Electrostatic Discharge Immunity (Performance criterion B)
	IEC 61000-4-3 / 2008	Radiated RF Electromagnetic Field Immunity (Performance criterion B)
	IEC 61000-4-4 / A1-2009	Electrical Fast Transient / Burst Immunity (Performance criterion B)
	IEC 61000-4-5 / 2007 <sup>2</sup>	Power Line Surge Immunity (Performance criterion B)
	IEC 61000-4-6 / 2009	Conducted RF Immunity (Performance criterion B)
	IEC 61000-4-11 / 2005 <sup>2</sup>	Voltage Dips and Interruptions Immunity (Performance criterion B)
Australia / New Zealand Declaration of Conformity- EMC	Complies with the Radiocommunications Act and demonstrated per EMC Emission standard <sup>1</sup>	
	AS/NZS 2064	Industrial, Scientific, and Medical Equipment: 1992
FCC EMC Compliance	Emissions comply with the Class A Limits of FCC Code of Federal Regulations 47, Part 15, Subpart B <sup>1</sup> .	

<sup>1</sup> Compliance demonstrated using high-quality shielded interface cables

<sup>2</sup> Applies only to units with AC mains supply instead of or additional to the SELV supply

Category	Standards or description	
EC Declaration of Conformity – Low Voltage	Compliance is given to the following specification as listed in the Official Journal of the European Communities: Low Voltage Directive 2006/95/EEC	
	EN 61010-1 / 2002	Safety requirements for electrical equipment for measurement control and laboratory use.
U.S. Nationally Recognized Testing Laboratory Listing	UL 61010-1 / 2004	Standard for electrical measuring and test equipment.
Canadian Certification	CAN/CSA C22.2 no. 61010-1-4 / 2008	Safety requirements for electrical equipment for measurement, control, and laboratory use.
Additional Compliance	IEC61010-1 / 2002	Safety requirements for electrical equipment for measurement, control, and laboratory use.
Equipment Type	Test and measuring	
Safety Class	Class 1 (as defined in IEC 61010-1, Annex H) – grounded product	
ATEX	<b>II 2G Ex d [ia] IIC T4 Gb</b>  <b>II (2)G [Ex ia Gb] IIC</b> <b>II 2G Ex ia IIC T4 Gb</b>	KCE800*-WE-*-*-Ex KCM0300 ... 3000-*****-Ex KCE800*-SE-*-*-Ex KCM0300 ... 3000

## 7.3 Technical Data

### 7.3.1 Technical Data KCM Transducer

	KCM0300	KCM0600	KCM1500	KCM3000
Max. flow (kg/h)	300	600	1500	3000
Min. flow (kg/h)	3	6	15	30
Max. flow (lb/min)	11.0	22.0	55.0	110
Min. flow (lb/min)	0.11	0.22	0.55	1.10
Basic Accuracy (% of flow)	0.1			
Zero Stability (% of f. s.)	0.01			
Zero Drift (% f.s. per °C)	0.001			
Repeatability (% of flow)	0.1			
Density meas. range	0 - 4500 kg/m <sup>3</sup>			
Density accuracy	±0.002 kg/ltr.			
Temperature accuracy	±1°C ±0.5% of reading			
Process and Ambient				
Process connections	female thread 1/2" adaptors for flanges, diary and tri-clamp			
Max. pressure	200 bar			
Max. pressure (Option)	350 bar			
Pressure Drop at max. flow H <sub>2</sub> O	see diagram			
Operating Density range	500 - 2500 kg/m <sup>3</sup>			
Process temperature	-100 ... +150°C (different ranges)			
Ambient temperature	-20 ... +70°C			
Storage temperature	-40 ... +100°C			
El. connections remote	screw type terminals			
El. connections compact.	none (internally connected to the electronics)			
Ingress Protection	IP67			
General				
Tube arrangement	2 serial	2 parallel	2 serial	2 parallel
Tube inner diameter	4mm	4mm	8mm	8mm
Tube material	stainless steel DIN 1.4571			
Housing material	stainless steel DIN 1.4571			
Dimensions	see drawings			

### 7.3.2 Ex Data KCM Transducer

	All KCM types
Driver coil	
Vmax (V)	35
I <sub>max</sub> (mA)	100
P <sub>max</sub> (W)	0.5
R <sub>i</sub> (Ohm)	55
L (mH)	2.77
C (nF)	<< 1
Sensor coil	
Vmax (V)	35
I <sub>max</sub> (mA)	100
P <sub>max</sub> (W)	0.5
R <sub>i</sub> (Ohm)	55
L (mH)	2.77
C (nF)	<< 1
Pt1000	
Vmax (V)	12
I <sub>max</sub> (mA)	60
P <sub>max</sub> (W)	0.2
R <sub>i</sub> (Ohm)	> 900
L (mH)	<< 0.1
C (nF)	<< 1

### 7.3.3 Technical Data KCE 8000 Transmitter

<b>General</b>	
Display:	Graphic, 132 x 32 dot
Supply voltage:	24 VDC, $\pm 20\%$
Programming:	via front keyboard
Interface:	RS 485, option HART or Foundation Fieldbus
EMC:	according to EN 50 081-2 and EN 50 082-2
Power consumption:	max. 4 W
<b>Exd housing:</b>	
Dimensions:	see drawing
Connections:	internal screw type terminals 1/2" female NPT cable gland
Material:	aluminum diecast
Protection class	IP 65
Weight:	approx. 2 kg
Temperature:	operating: - 20 up to 50°C storage and transport: -20 up to 70°C
<b>Panel-mounted housing:</b>	
Dimensions:	see drawing
Connections:	rear screw type terminals
Material:	Noryl
Protection class:	front: IP 60, rear: IP 30
Weight:	approx. 500g
Temperature:	operation: 0 to 50°C storage and transport: -20 up to 70°C

<b>Analog Outputs</b>	
Two current outputs:	4-20 mA passive, two-wire, isolated
Resolution:	14 bit
Linearity:	± 0.05% of full scale
Temperature drift:	0.05% per 10K
Load:	< 620 Ω (at 24V supply)
Output value:	flow rate, job total, density or temperature
<b>Pulse Output</b>	
Frequency range:	0.5 -10,000 Hz
Output signal:	active push pull output of flow rate and / or cycle output
<b>Digital I/O</b>	
Status output type	push pull
Low / high level	1V / 23V @ 24Vsupply, 10kΩ load
Allowed load current	20mA max.
Output signal	Programmable
Control input type	Active high
Threshold voltage	6.5V
Input current	0.1mA @ 6.5V, 0.2mA @ 24V Vin
Input signal	Programmable

### 7.3.4 Ex Data KCE Transmitter

#### Barrier output

Driver coil hot side	
Vmax (V)	7
I <sub>max</sub> (mA)	100
P <sub>max</sub> (W)	0.42
Driver coil cold side	
Vmax (V)	1
I <sub>max</sub> (mA)	100
P <sub>max</sub> (W)	0.1
Sensor coil	
Vmax (V)	1.8
I <sub>max</sub> (mA)	23
P <sub>max</sub> (W)	0.08
Pt1000 driver	
Vmax (V)	5
I <sub>max</sub> (mA)	58
P <sub>max</sub> (W)	0.25 (< 0.028W @ R(Pt1000) > 900 Ohm)

### 7.3.5 Dimensional Drawings (mm)

#### Compact versions

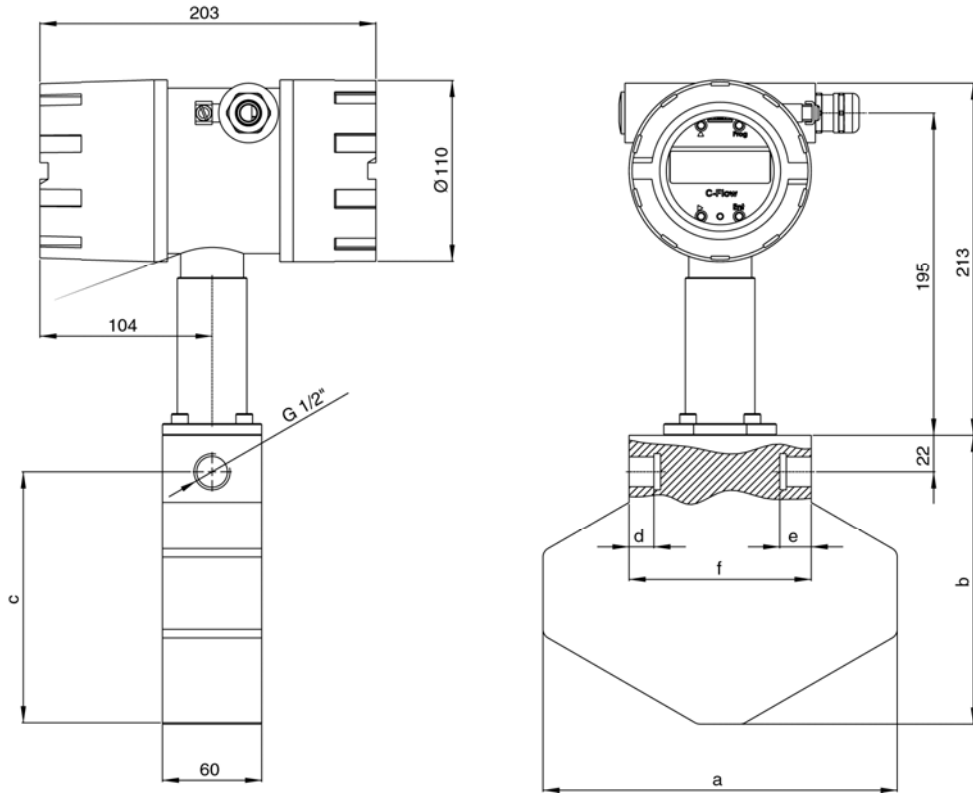


Fig. 20: Dimensions KCM0300-C\*-\*\*\*\*\* through KCM3000-C\*-\*\*\*\*\*

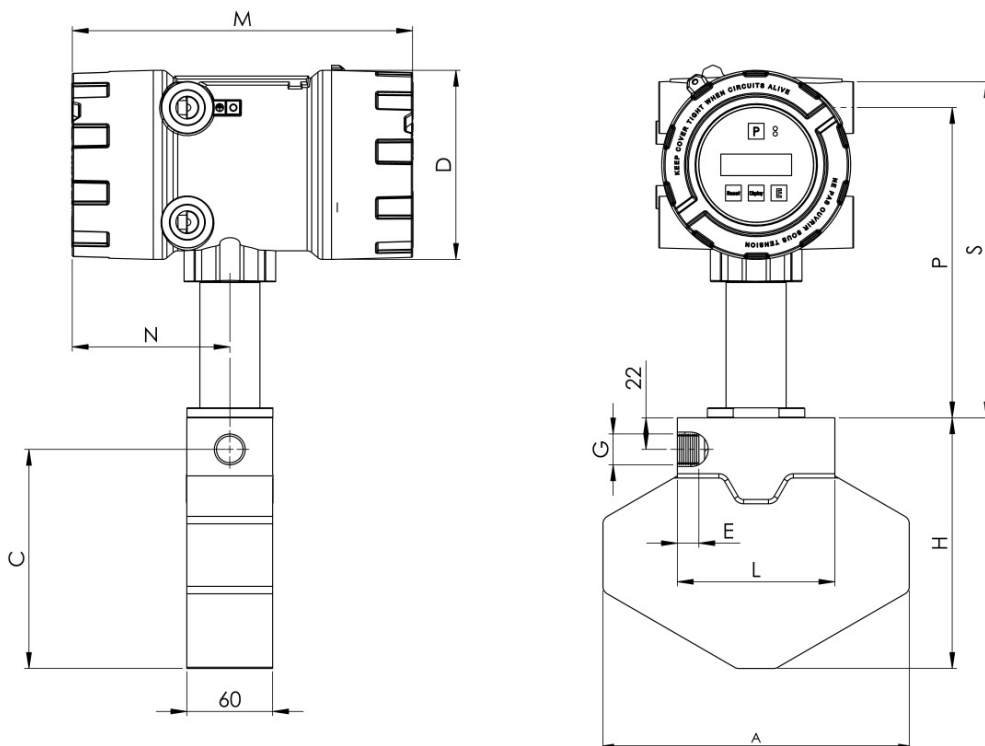


Fig. 21: Dimensions KCM0300-D\*-\*\*\*\*\* through KCM3000-D\*-\*\*\*\*\*

**Sensor Dimensions**

Type	A	H	C	E	L	G
KCM 0300	214	182	160	15	110	½"
KCM 0600	214	182	160	15	87	½"
KCM 1500	350	280	258	18	140	½"
KCM 3000	350	280	258	18	140	½"

**Electronics Dimensions**

Type	D	M	N	P	R
Housing "C"	110	205	118	188	218
Housing "E"	130	240	111	217	243

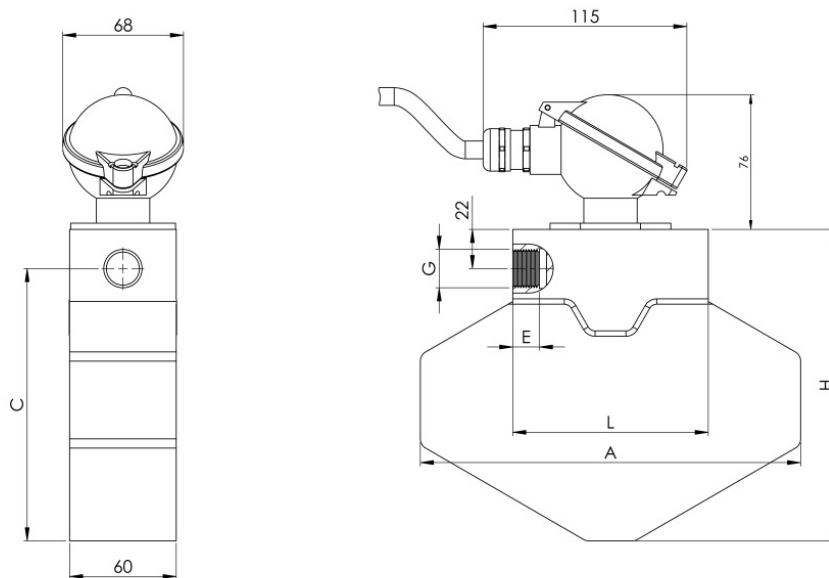
**Remote meter**

Fig. 22: Dimensions KCM\*\*\*\*-0 or KCM\*\*\*\*-1

Remote wall-mounted electronics

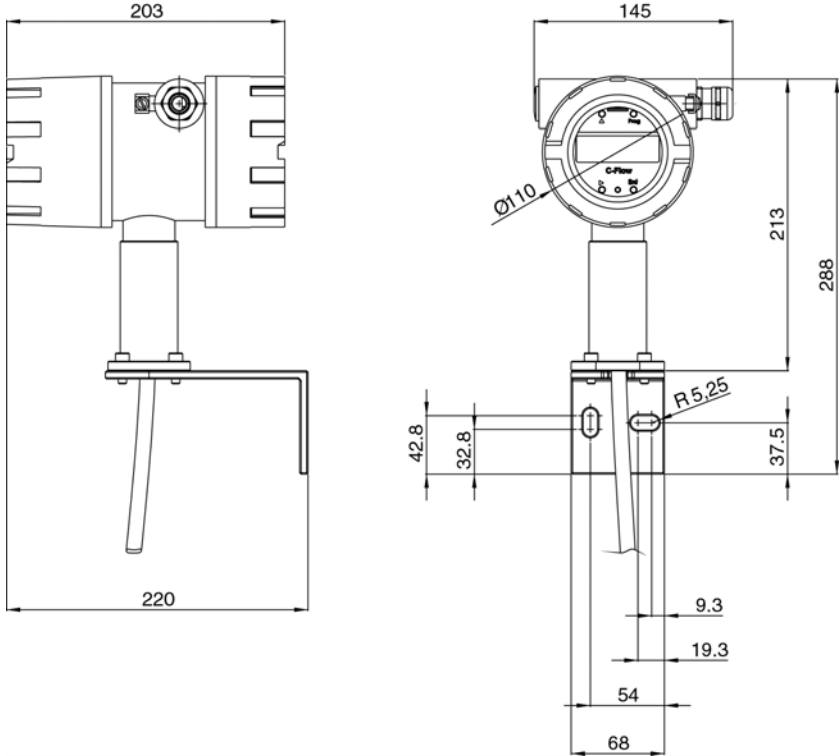


Fig. 23: Dimensions KCE80xx-WG

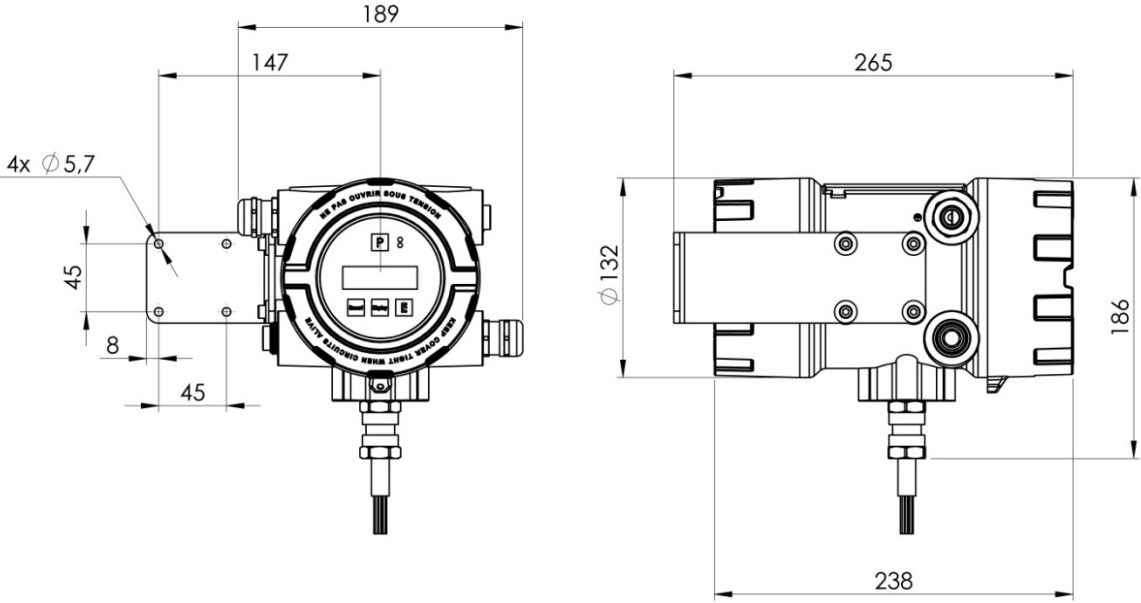


Fig. 24: Dimensions KCE80xx-WE

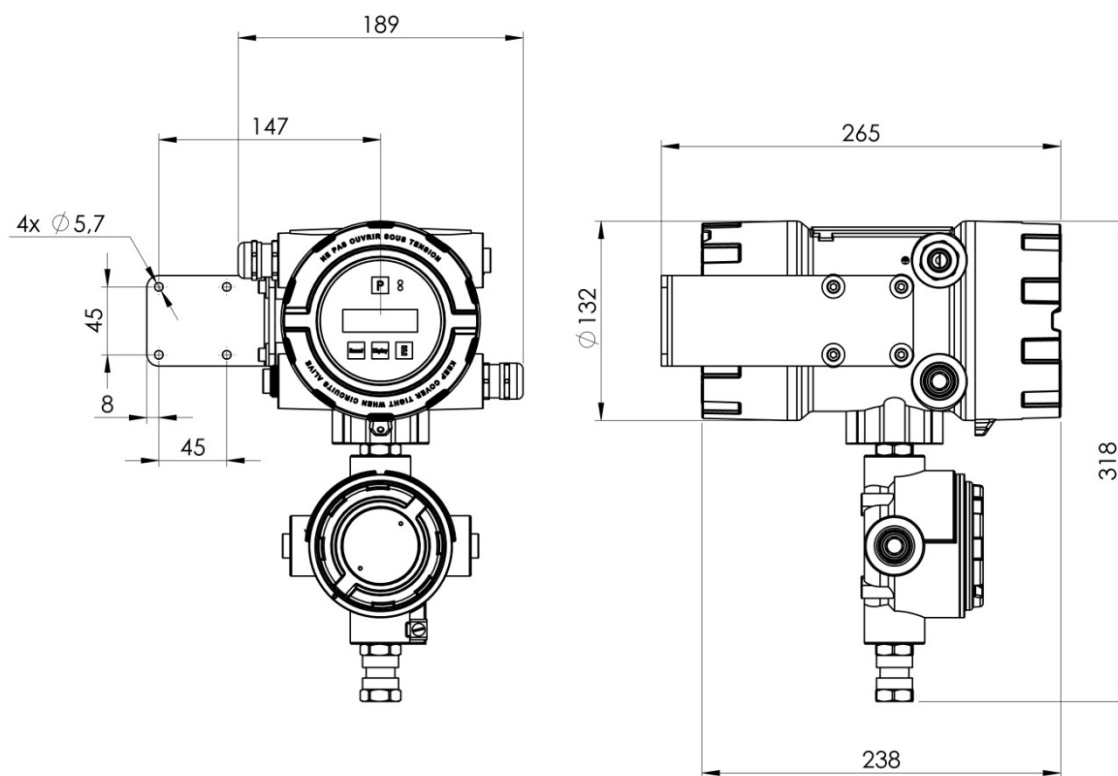
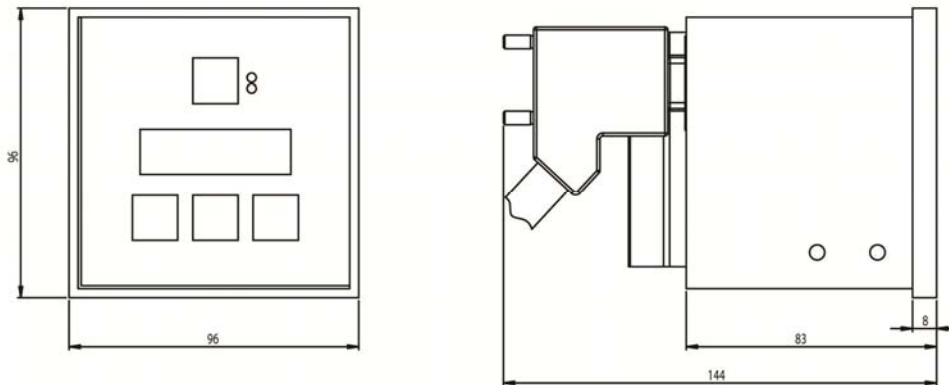


Fig. 25: Dimensions KCE80xx-WE with junction box

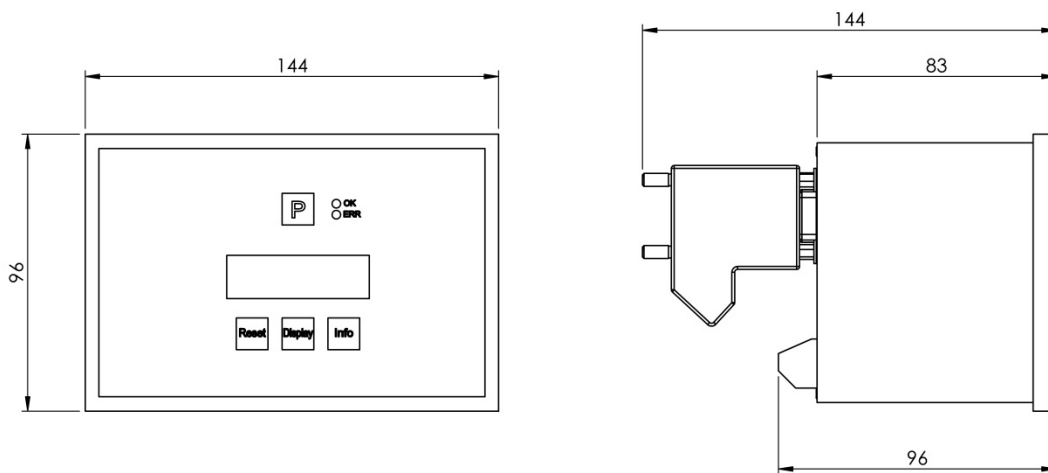
**Remote panel-mounted housing**



**Fig. 26: Dimensions KCE80xx-WE**

The required cutout for the panel is 92mm +0.8/-0mm x 92mm +0.8/-0mm.

The maximum thickness of the panel is 2mm.



**Fig. 27: Dimensions KCE80xx-WE**

The required cutout for the panel is 138mm +1.0/-0mm x 92mm +0.8/-0mm.

The maximum thickness of the panel is 2mm.

## 7.4 WEEE and RoHS

The unit described herein is not subject to the WEEE directive and the corresponding national laws.

At the end of life forward the unit to a specialized recycling company and do not dispose it off as domestic waste.

The unit described herein fully complies with the RoHS directive.

## 7.5 List of figures

FIG. 1: COMPACT VERSION .....	7
FIG. 2: SEPARATE VERSIONS, WALL MOUNT (LEFT) AND PANEL MOUNT (RIGHT) .....	7
FIG. 3: FLECTIONS OF THE TUBES WITH AND WITHOUT FLOW .....	12
FIG. 4: OPERATING ELEMENTS OF KCE80XX-WG AND COMPACT VERSION .....	14
FIG. 5: OPERATING ELEMENTS OF KCE80XX-SG .....	15
FIG. 6: OPERATING ELEMENTS OF TCE80XX-SE-* -EX .....	15
FIG. 7: OPERATING ELEMENTS KCM .....	16
FIG. 8: ELECTRICAL TERMINALS KCE80XX-WG AND COMPACT VERSION .....	17
FIG. 9: ELECTRICAL TERMINALS TCE80XX-E-* -EX AND COMPACT VERSION .....	19
FIG. 10: ELECTRICAL TERMINALS KCE80XX-SG .....	21
FIG. 11: ELECTRICAL TERMINALS KCE80XX-SG-* -EX .....	23
FIG. 12: RECOMMENDED HORIZONTAL INSTALLATION .....	28
FIG. 13: VERTICAL INSTALLATION .....	28
FIG. 14: INSTALLATION IN A DROP LINE .....	29
FIG. 15: CRITICAL INSTALLATIONS .....	29
FIG. 16: WIRING DIAGRAM FOR POWER CONNECTIONS, DC OPERATION .....	34
FIG. 17: WIRING DIAGRAM FOR POWER CONNECTIONS, AC OPERATION .....	35
FIG. 18: WIRING DIAGRAM FOR DIGITAL I/O CONNECTIONS .....	36
FIG. 19: WIRING DIAGRAM FOR 4-20MA CURRENT LOOP .....	37
FIG. 20: DIMENSIONS KCM0300-C*_***** THROUGH KCM3000-C*_***** .....	88
FIG. 21: DIMENSIONS KCM0300-D*_***** THROUGH KCM3000-D*_***** .....	88
FIG. 22: DIMENSIONS KCM****-0 OR KCM****-1 .....	89
FIG. 23: DIMENSIONS KCE80XX-WG .....	90
FIG. 24: DIMENSIONS KCE80XX-WE .....	90
FIG. 25: DIMENSIONS KCE80XX-WE WITH JUNCTION BOX .....	91
FIG. 26: DIMENSIONS KCE80XX-WE .....	92
FIG. 27: DIMENSIONS KCE80XX-WE .....	92

## 7.6 List of tables

TAB. 1: CONNECTIONS KCMXXXX .....	32
TAB. 2: ERROR CODES .....	45
TAB. 3: LIST OF SERVICE PARAMETERS .....	46
TAB. 4: LIST OF UNIT INFO .....	46

## 7.7 Addresses

### Headquarter

KEM  
Küppers Elektromechanik GmbH  
Liebigstraße 5  
DE-85757 Karlsfeld  
Germany

Tel.: +49 8131 593910  
[info@kem-kueppers.com](mailto:info@kem-kueppers.com)  
[www.kem-kueppers.com](http://www.kem-kueppers.com)

# Contact

## KEM Headquarter

Liebigstraße 5  
85757 Karlsfeld  
Germany

T. +49/8131/ 59 39 1-0

F. +49/8131/ 92 60 4

[info@kem-kueppers.com](mailto:info@kem-kueppers.com)

## KEM Service & Repairs

Wetzeller Straße 22  
93444 Bad Kötzing  
Germany

T. +49/9941/ 94 23 0

F. +49/9941/ 94 23 23

[info@kem-kueppers.com](mailto:info@kem-kueppers.com)

*More distributors & partners can be found at:  
[www.kem-kueppers.com](http://www.kem-kueppers.com)*

Your local partner:



[www.kem-kueppers.com](http://www.kem-kueppers.com)

[info@kem-kueppers.com](mailto:info@kem-kueppers.com)