

FLOW SENSOR FHKU
THE ALL-ROUNDER
MADE BY DIGMESA

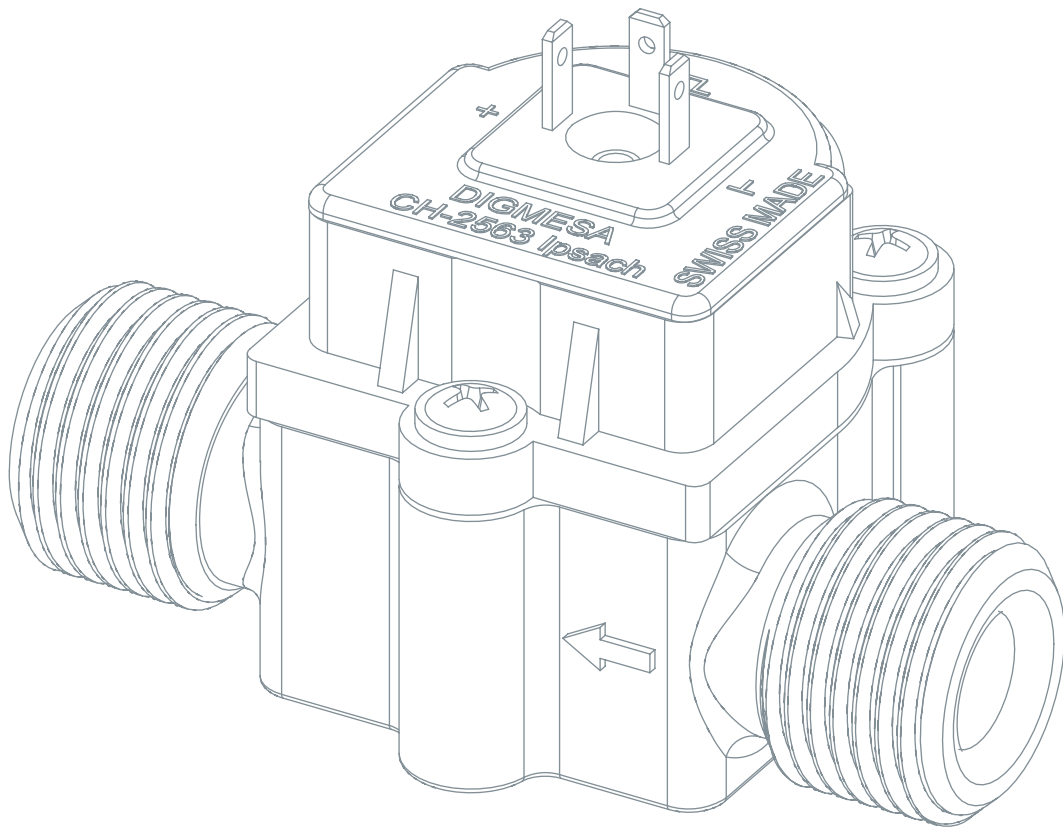

FLOW SENSOR FHKU LCD
COMPACT EVALUATION
MADE BY DIGMESA

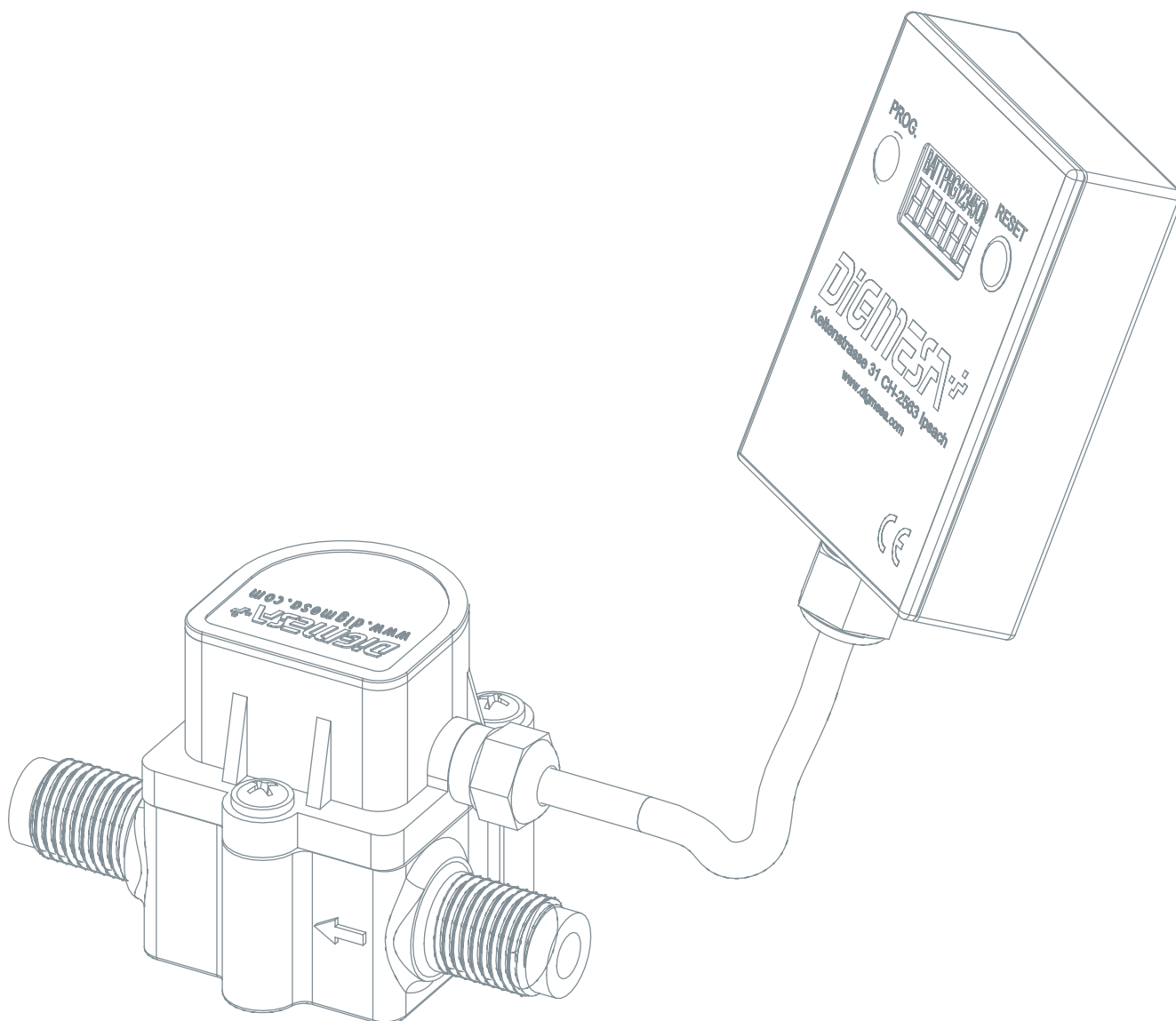

The Classicline FHK and FHKU are also available with a display to enable simple, direct monitoring of the flowing medium. This display can be integrated into the upper part of the device, or it can be delivered separately and connected via a cable. This device is ideal for applications such as checking for compliance with maintenance cycles in water filters due to its many functions, such as count-down, count-up, display of instantaneous flow rate, timed control and data storage.

FLOW SENSOR FHKU TECHNICAL INFORMATION

Flow Rate l/min		
Nozzle	Min	Max
1.0 mm	0.04	0.60
1.2 mm	0.05	0.80
2.0 mm	0.10	2.40
2.5 mm	0.15	3.80
5.6 mm	0.30	9.30
7.0 mm	1.40	18.00
10.0 mm	3.00	30.00

Output Signal
Pulse

Material
Arnite, PPS (Ryton), PA (Grivory), PVDF

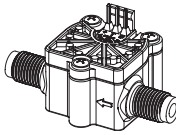
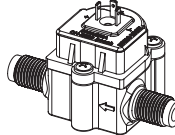
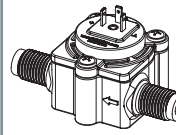
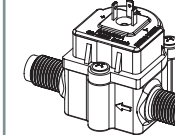
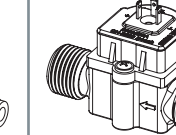
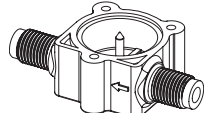
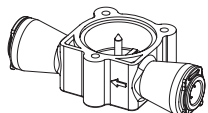
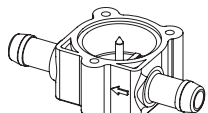
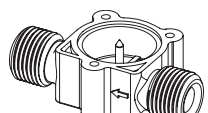
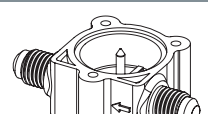

Application examples
Chemistry, Industry, Semiconductor Industry, Beverage

The universal Classicline FHK or FHKU is used in practically every imaginable field, such as in the food-stuffs, chemical, industrial and semiconductor sectors. The two versions differ in the position of their connections: In the FHK, they are side by side, while in the FHKU, they are opposite each other. This flow sensor is available in many different configurations and can easily be adapted to meet special customer requirements. The newly developed ceramic bearing is also suitable for applications requiring continuous day-and-night operation.

	FHKUC	FHKU	FHKU flat	FHKU Chemistry	FHKU HighFlow
					
Housing Material					
PBT (Arnite)	STD	STD	STD	-	STD
PPS (Ryton)	•	•	-	-	•
PA (Grivory)	•	•	-	-	•
PVDF	-	-	-	STD	•
Process Connection					
 G 1/4" male	STD	STD	STD	STD	STD
 John Guest	•	•	•	-	•
 hose nipple 7mm	•	•	•	-	•
 G 1/2" male 10mm	•	•	•	•	•
 Cola	•	•	•	-	•

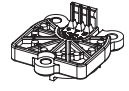
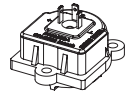
customer specific on request

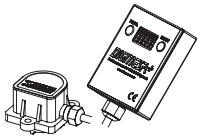
	FHKC	FHK	FHK flat	FHK Chemistry	FHK HighFlow
EI. Connection					
 Pancon Mas-Con	STD	-	-	-	-
 3 pin amp	-	STD	STD	STD	STD
Resistor 1.2k	•	•	•	•	•
3 pin amp LED	-	•	-	•	•
3 pin amp PNP	-	•	-	•	•

	FHKC	FHK	FHK flat	FHK Chemistry	FHK HighFlow
3 pin amp PNP/LED	-	•	-	•	•
cable	-	•	•	•	•
empty detection	-	•	-	-	-
Thermo	-	-	-	•	-
 Display extl.	-	•	-	•	•
 Display intl.	-	•	-	-	•

O-Ring						
Silicone		STD	STD	STD	-	STD
EPDM		•	•	•	•	•
Viton		•	•	•	STD	•
Kalrez		-	-	-	on request	-

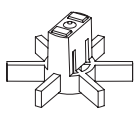
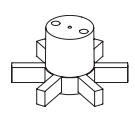
Turbine						
FT 36 2M		STD	STD	STD	-	-
Chem. 2M		•	•	•	STD	STD
Chem. 4M		•	•	•	•	•

Bearing Pin						
Inox 1. 4305		STD	STD	STD	-	-
Inox 1. 4571		•	•	•	-	-
PCTFE		-	-	-	STD	-
Ceramic		-	-	-	-	STD

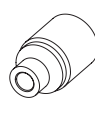
Nozzle						
1.0 mm		•	•	•	•	•
1.2 mm		•	•	•	•	•
2.0 mm		•	•	•	•	•
2.5 mm		•	•	•	•	•
5.6 mm		STD	STD	STD	STD	STD
7.0 mm		•	•	•	•	•
10.0 mm		•	•	•	•	•