

Delivery address: Mackenrodtstraße 14,
36039 Fulda, Germany
Postal address: 36035 Fulda, Germany
Phone: +49 661 60 03-0
Fax: +49 661 60 03-6 07
E-mail: mail@jumo.net
Internet: www.jumo.net

JUMO House
Temple Bank, Riverway
Harlow, Essex CM20 2TT, UK
Phone: +44 12 79 63 55 33
Fax: +44 12 79 63 52 62
E-mail: sales@jumo.co.uk

885 Fox Chase, Suite 103
Coatesville PA 19320, USA
Phone: 610-380-8002
1-800-554-JUMO
Fax: 610-380-8009
E-mail: info@JumoUSA.com
Internet: www.JumoUSA.com



Pressure transmitter JUMO dTRANS p02 DELTA

Type 404382

General application

The JUMO dTRANS p02 DELTA pressure transmitter measures the differential pressure in both corrosive and non-corrosive gases, vapors and liquids. The pressure transmitter makes use of the piezo-resistive effect to make the measurement. The output signal is a DC current which is linearly proportional to the input pressure. With flow-through measurements, it is possible to set up the output signal to be proportional to the square-root of the input pressure.

In the version with Protection EEx ia IIC, the transmitter can be mounted within the hazardous area Zone 1, for connection to Zone 0.

A wide spectrum of pressure separators is available for special applications such as level measurements, or for corrosive media.

Display options:

- pressure with choice of 13 different units, measurement in % or scaled with freely selectable dimensional unit, output current in mA
- sensor temperature in °C or °F
- measurement error, out-of-range measurement
- minimum and maximum pressures (peak-reading pointer)
- pressure and sensor temperature can be shown simultaneously (2 lines)

Setting options via keys:

- start and end of measurement with pressure input
- start and end of measurement without pressure input (blind setting)
- damping or time constant
- current generator function
- output signal on error
- key inhibit
- reset min. and max. measured value (peak-reading pointer)
- square-root characteristic (adjustable starting point), or linear
- density correction for different measurement media
- display of temperature of medium in °C or °F

The JUMO dTRANS p02 DELTA pressure transmitter can also be used with a HART® communicator or a PC in conjunction with a HART® modem and the JUMO setup program running under Windows®.

Accessories

Setup program

Sales No. 40/00365072.

The setup program for all instruments of the JUMO dTRANS p02 series has been created according to the VDI/VDE 2187-user interface. Together with the HART® modem, the program enables easy operation and parameter setting of the pressure transmitter from a PC.

HART® modem

Sales No. 40/00345666

The HART® modem provides the link between the JUMO dTRANS p02 transmitter and the serial interface of a PC.

Bracket for wall and pipe mounting

Sales No. 40/00314729

Triple valve block

Sales No. 40/00308191
to DIN 19 213, stainless steel
other valve types on request.

Oval flange 1/2" NPT

Sales No. 40/00398914
to DIN 19 213, stainless steel.
Set of 2, with M10 screws.
Other flange types on request.

Supply isolator for Ex applications, HART® capable

Sales No. 40/00389710,
see Data Sheet 40.4757

Pressure separators

for adaptation to special applications, whenever conventional pressure connection cannot be used.
See Data Sheets 40.9770 to 40.9786



Technical data

Explosion protection

to EN 50 014 and EN 50 020
(CENELEC)
tested to Directive 94/9/EC
(ATEX 100a)
Protection EEx ia IIC T4-T6,
Category 1/2G (use in Zone 1, connection to Zone 0)
PTB 98 ATEX 2194

The supply must be intrinsically safe and must not exceed the following maximum values:

U_i = 30V DC
I_i = 100mA
P_i = 750mW

Reference conditions

as per DIN 16 086 and IEC 770/5.3

Nominal input range

see Order details

Range setting

The measurement range can be set from the transmitter keys, by using the setup program or a HART® communicator as described below:

Start and end of the measurement range can be continuously adjusted within the nominal range.

The span should not go below 10% of the nominal range.

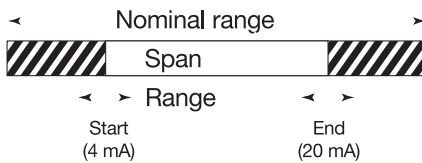

Displayable units

mH₂O, inH₂O, inHg, ftH₂O, mmH₂O, mm Hg, psi, bar, mbar, kg/cm², kPa, Torr, MPa; Measurement:

% or scaled with freely adjustable unit

Output current:

mA

Additional displays

indication of sensor temperature, minimum pressure, maximum pressure.

Indication on overrange and on error.

Density correction

adjustable within the range from 0.100 to 5.000 kg/dm³

Nominal pressure

PN 160

option: PN 420

Parts in contact with medium

as standard:

stainless steel, Mat. Ref. 1.4401, 1.4404

flanges: stainless steel, Mat. Ref. 1.4408

O ring: FPM (Viton®)

option: see Order details

Pressure connection

see Order details

Output

4 – 20 mA burden $\leq (U_B - 11.5 \text{ V}) / 0.022 \text{ A}$
burden with HART® max. 1100 Ω, min. 250 Ω

with HART® protocol V 5.3.

Complies with the Directives of the HCF (HART® Communication Foundation)

Characteristic

linear or square-root. Adjustable starting point with square-root characteristic (ex-factory is linear up to 9.4%).

Burden error

< 0.1%

Zero offset / adjustment accuracy

≤ 0.01 mA

Effect of static pressure

zero: ≤ 0.015%/10 bar

span: ≤ 0.020%/10 bar

Ambient temperature error

within range -20 to +85°C

(compensated temperature range)

zero: ≤ 0.005% per °C typical,

≤ 0.01% per °C max.

span: ≤ 0.005% per °C typical,

≤ 0.01% per °C max.

Deviation from characteristic

limit point adjustment:

≤ 0.1% of full scale of nominal range;

as per DIN 16 086

Hysteresis

≤ 0.02% of full scale; as per DIN 16 086

Reproducibility

≤ 0.02% of full scale; as per DIN 16 086

Response time

150 msec approx., no damping

Damping

adjustable from 0 – 100 sec

Stability per year

≤ 0.1% of full scale (for nominal range at reference conditions as per IEC 770)

Supply

11.5 – 36V DC

11.5 – 30V DC (for intrinsically safe version)

Supply unit for output signal transmission with or without HART® communication, in intrinsically safe version, see Data Sheet 40.4757.

Note:

Minimum 17V DC (250Ω) for communication via HART® protocol.

Supply voltage error

≤ 0.1% of full scale per 10 V change

(nominal supply voltage 24 V DC)

Permissible ambient temperature

-40 to +85°C; as per DIN 16 086

(the LCD display may not be readable at temperatures below -20°C)

With intrinsically safe version:

+85°C with temperature class T4

+75°C with temperature class T5

+60°C with temperature class T6

Storage temperature

-40 to +85°C

Permissible temperature of medium

-40 to +100°C

(with halogenized filling oil -10 to +100°C)

Electromagnetic compatibility (EMC)

as per EN 61 326

Mechanical shock

50g/11 msec

Mechanical vibration

5g max. at 10 – 2000Hz

Protection

with connecting cable

IP65 to EN 60 529

Insulation resistance

100 MΩ; 50 V DC

Breakdown strength

≥ 500 V_{eff}.

Housing

aluminium die-casting GDAISI12

Flange screws

steel, yellow-chromed

option: stainless steel

Climatic conditions

≤ 80% rel. humidity with condensation, annual mean

Electrical connection

clamping case with screw cover, 2-pole and earthing terminal, plastic cable gland M20 x 1.5 for cable diameters 6 to 12 mm

Nominal position

ex-factory: upright vertical

(pressure cell below)

any operating position

Weight

3.9 kg approx.

HART® communication

between PC and pressure transmitter

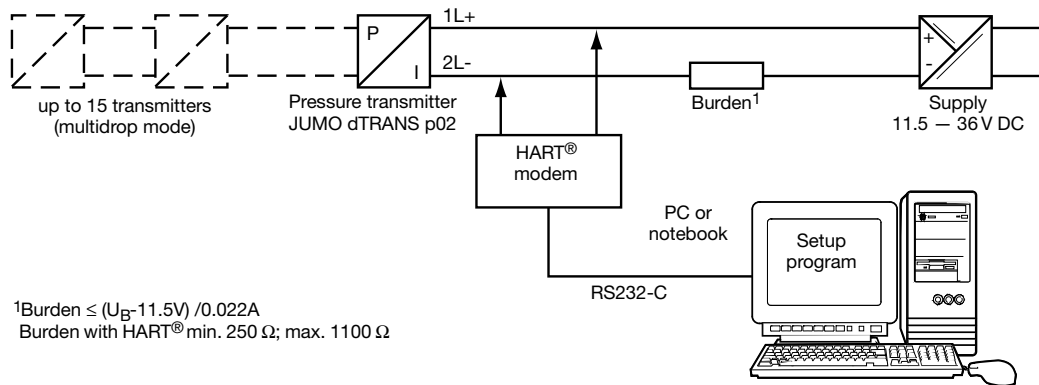



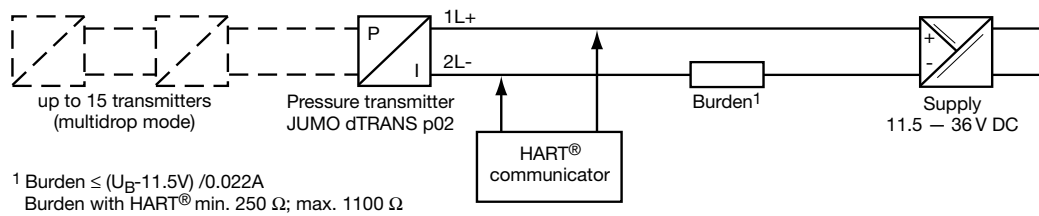

between HART® communicator and pressure transmitter

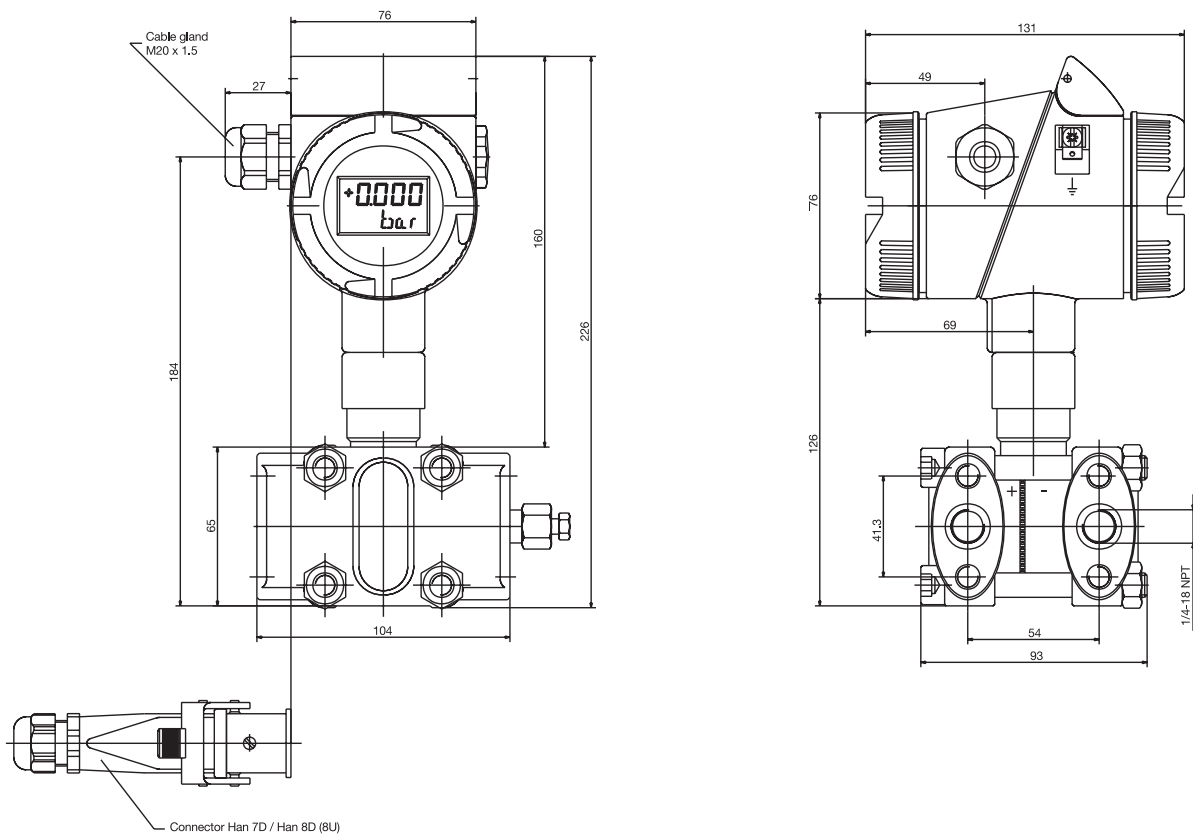

Dimensions



Electrical connection

Connection		Terminals
Supply 11.5 — 36 V DC		1 L+ 2 L-
Output 4 — 20 mA 2-wire		1 L+ proportional current 4 — 20 mA 2 L- in supply
Test connection for current output	internal resistance of ammeter ≤ 10 Ω	TEST + TEST -
Test connection for HART®	burden must be present!	TEST + HART®
Potential equilibration (for intrinsically safe circuit)		
Shielding		

Caution:
Earth instrument!
(pressure connection and shielding)

Terminal assignment

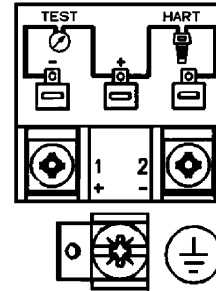

Order details

404382	Basic type pressure transmitter dTRANS p02 DELTA
	Basic type extension
0	none
1	Protection EEx ia II C (PTB 98 ATEX 2194)
5	increased nominal pressure PN 420
	Nominal input range
413	60 mbar differential pressure
451	250 mbar differential pressure
454	1 bar differential pressure
457	4 bar differential pressure
461	25 bar differential pressure
	Output
405	4 — 20 mA with HART® protocol
	Process connection
511	2 x pressure connection 1/4-18 NPT, DIN 837
998	suitable for connection to diaphragm-type pressure separators
	Material for process connection
20	stainless steel, Mat. Ref. 1.4401, 1.4404, flange Mat. Ref. 1.4408
82	Hastelloy® C276 + Mat. Ref. 2.4819, flange Mat. Ref. 1.4408
83	Monel, Mat. Ref. 2.4360, flange stainless steel Mat. Ref. 1.4408
	Fastening thread
113	M10 ¹ (standard)
117	M12 (PN 420)
152	7/16-20 UNF
	Seals
601	FPM (Viton®)
603	PTFE (Teflon®, suitable for comestibles)
604	FFPM (Kalrez®)
	Meas. system filling medium
1	silicone oil
2	halogenized filling oil for oxygen applications
	Flange screws
1	steel, yellow-chromed
2	stainless steel ²
404382 / [] - [] - 405 - [] - [] - [] - [] - [] - [] - []	Order code

Factory setting:

Please specify the measurement range to be set and the dimensional unit in plain text.

¹ not for "increased nominal pressure PN420" (404382/5-....)

² in conjunction with "increased nominal pressure PN420" (404382/5-....), only up to PN315