

FE8B Series

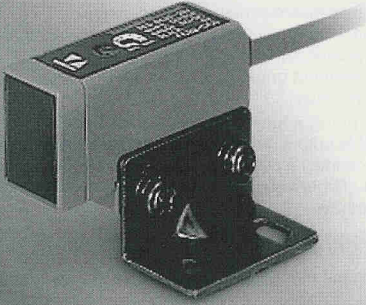

Rugged housing, IP67 seal, self-diagnostic output and external diagnostic functions.



- Compact 16 x 21 x 45mm size
- Rugged die-cast zinc ultraminiature housing
- IP67 seal
- Light quantity drop and optical-axis shift can be prevented by use of the self-diagnostic indication and output function (thru scan models)
- Photoelectric sensors can be checked at start-up of line by use of external diagnostic function (thru scan)
- Lens is protected by glass



ORDER GUIDE

Standard type (2m cable)

Appearance	Detection method	Scanning distance	Power supply	Output mode	Operating mode						Catalog listing		
					Light-operated	Dark-operated	Selectable	Sensitivity adjustment	Self-diagnostic indication	Self-diagnostic output		External diagnostics	
Horizontal 	Thru scan	5m	10 to 28Vdc	NPN open collector			●	●				FE8B-TC6	
		7m			●						FE8B-TC6G		
	Retroreflective	0.1 to 2m					●	●	●	●			FE8B-TA6P
		0.3m					●						FE8B-TMC6
	Diffuse scan	0.3m					●	●	●				FE8B-RC6
		0.5m					●	●	●				FE8B-DC6
Vertical 	Thru scan	5m					●	●				FE8B-DLC6	
		7m			●	●	●					FE8B-TC6V	
	Retroreflective	0.1 to 2m			●			●	●			FE8B-TC6VG	
		0.3m			●			●	●			FE8B-TA6VP	
	Diffuse scan	0.3m			●			●	●			FE8B-TMC6V	
		0.5m			●			●	●			FE8B-RC6V	
							●	●			FE8B-DC6V		
							●	●			FE8B-DLC6V		

- PHOTOELECTRIC SENSORS
- MEASUREMENT SENSORS
- PROXIMITY SENSORS
- LIMIT SWITCHES
- SAFETY INTERLOCK SWITCHES
- BASIC SWITCHES
- MANUAL SWITCHES
- HP100
- HPJ
- HPA
- HLA
- HLB
- FHDK10
- FE8B
- FE7D
- HPV
- FE8V
- FE7W

ACCESSORIES (sold separately)

Name	Appearance	Details	Catalog listing	Compatible sensor
Small reflector for polarized retroreflective model		A small reflector used when mounting space for the reflector is limited. Not included with the FE8B.	FE-RR15	FE8B Polarized retroreflective model
Reflector for polarized retroreflective model		Not included with the FE8B.	FE-RR8	

SPECIFICATIONS

Detection method	Thru scan		Retroreflective	Diffuse scan	
Catalog listing	FE8B-TC6(G) FE8B-TC6V(G) FE8B-TA6P FE8B-TA6VP	FE8B-TMC6 FE8B-TMC6V	FE8B-RC6 FE8B-RC6V	FE8B-DC6 FE8B-DC6V	FE8B-DLC6 FE8B-DLC6V
Supply voltage	10 to 28Vdc				
Current consumption	Max 30mA (35mA for products with the self-diagnostic function)				
Scanning distance	5m	7m	0.1 to 2m (reflector: FE-RR8)	0.3m	0.5m
Target object	9mm dia. min. (opaque material)		50 x 50mm min. (opaque)	Transparent and opaque materials	
Standard target object	—		—	White paper 20 x 20cm	
Operation angle	Both emitter and receiver: 3 to 20°		Sensor: 2 to 10°	—	
Differential	—		—	20% max. of scanning distance	
Output mode	NPN transistor (open collector)				
Control output	Output switching current: max. 100mA (resistive load). Output dielectric strength: max. 30V. Voltage drop: max. 1V (at 100mA switching current).				
Self-diagnostic output	Operation mode: output transistor ON when incoming light is insufficient. Output mode: NPN transistor/open collector. Output switching current: max. 50mA (resistive load). Voltage drop: max. 1V (at 50mA switching current).				
External diagnostic function	When an input control terminal is connected to the plus terminal of the power supply, the light emitter stops emitting light.				
Response time	ON/OFF time 5ms max.	ON/OFF time 30ms max.	ON/OFF time 5ms max.		
Light emitter	Infrared LED				
Indicators	Light-ON (light input OK: green; light input insufficient: red), OFF when light blocked, thru scan emitter power indicator (red).				
Ambient light resistance	Incandescent lamp: 3,000 lux max. Sunlight: 10,000 lux max.				
Storage temperature	-20 to +60°C				
Temperature	-40 to +70°C				
Humidity range	35 to 85% RH (non-condensing)				
Insulation resistance	Min. 20MΩ (with 500Vdc megger)				
Dielectric strength	500Vac for one minute				
Vibration resistance	1.5mm double amplitude, 10 to 55Hz, 2 hours each in X, Y and Z directions				
Shock resistance	490m/s ² 10 times each in X, Y and Z direction				
Protective structure	IP67 (IEC standard)				
Wiring type	Preleaded				
Cable	4.2mm dia., 0.2mm ² (11/0.16) cross-sectional area, 2m long. 3 cores. Sheath color gray (thru scan model: 2 cores, black sheath).				
Material	Case: Die-cast zinc. Lens: PMMA resin (protected by glass).				
Weight	Approx. 105g (thru scan, for both emitter and receiver), body only with cable				
Circuit protection	Reverse power connection protection, false operation protection at power supply (approx. 70ms), output short-circuit protection.				

PHOTOELECTRIC
SENSORSMEASUREMENT
SENSORSPROXIMITY
SENSORSLIMIT
SWITCHESSAFETY
INTERLOCK
SWITCHESBASIS
SWITCHESMANUAL
SWITCHES

HP100

HPJ

HPA

HLA

HLB

FHDK10

FE8B

FE7D

HPV

FE8V

FE7W

DIE-CAST IP67 SEAL

A-156

SELF-DIAGNOSTIC INDICATION

Indicator lights up red when the incoming light quantity is in the unstable zone.

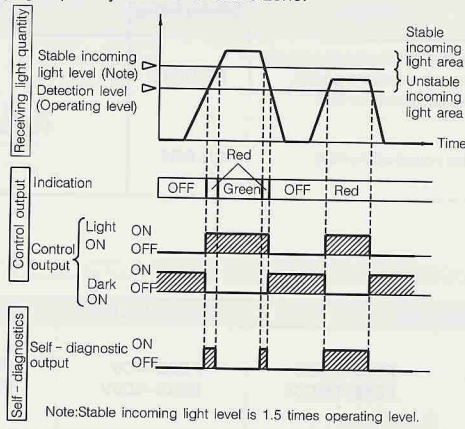

CHARACTERISTICS (typical)

● Excess gain (light received over required level)

Thru scan

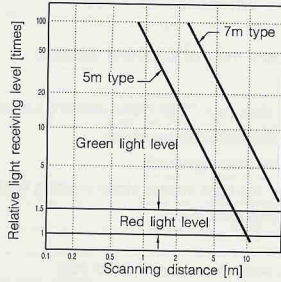

Retroreflective

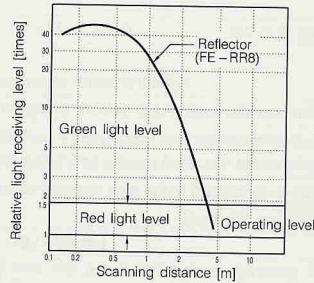

Diffuse scan

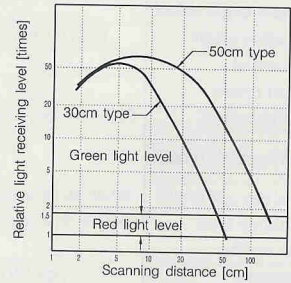

● Parallel displacement

Thru scan

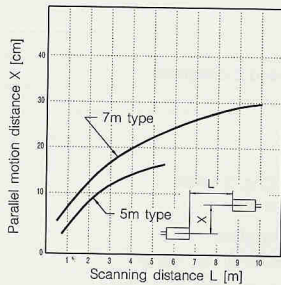

Retroreflective

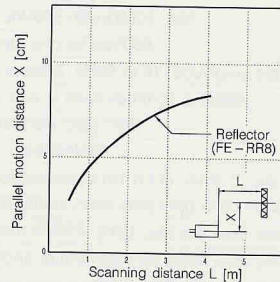

● Detection area

Diffuse scan

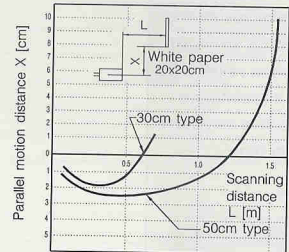

● Scanning distance vs. target object size

Diffuse scan

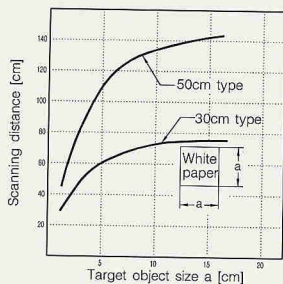

EXTERNAL DIMENSIONS

● Horizontal model

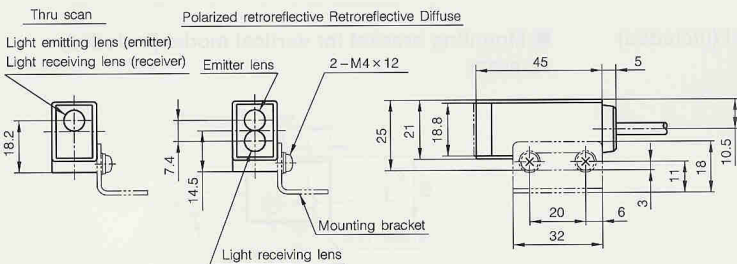
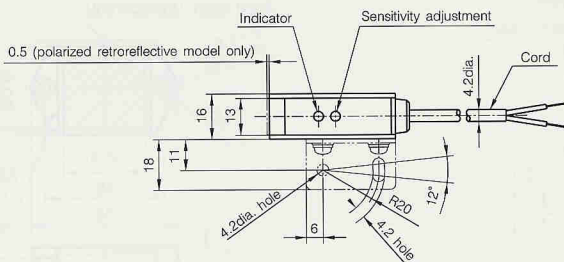

Notes: Mounting bracket, screws and screwdriver are provided.
 Lens effective diameter: 9dia.
 Products which have sensitivity adjustment feature have a sensitivity level adjustment pot. A screwdriver is provided for adjusting the pot.

● Vertical model

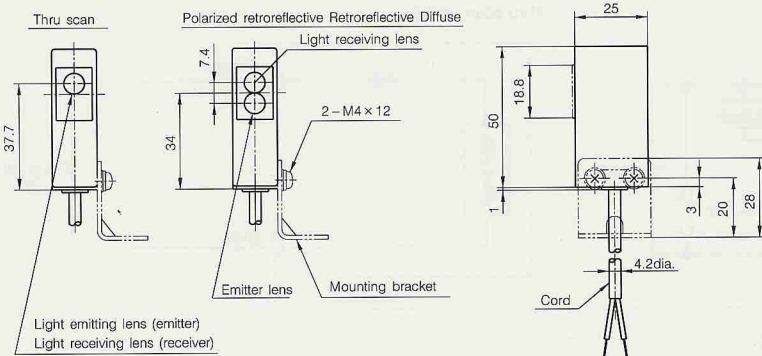
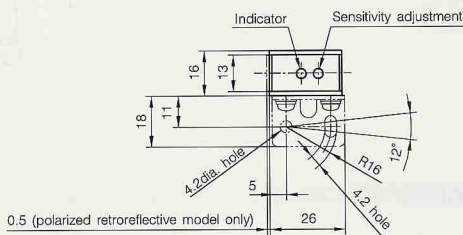

Notes: Mounting bracket, screws and screwdriver are provided.
 Lens effective diameter: 9dia.
 Products which have sensitivity adjustment feature have a sensitivity level adjustment pot. A screwdriver is provided for adjusting the pot.

SELF-CONTAINED

PHOTOELECTRIC SENSORS

MEASUREMENT SENSORS

PROXIMITY SENSORS

LIMIT SWITCHES

SAFETY INTERLOCK SWITCHES

BASIC SWITCHES

MANUAL SWITCHES

HP100

HPJ

HPA

HLA

HLB

FHDK10

FE8B

FE7D

HPV

FE8V

FE7W

DIE-CAST IP67 SEAL

● Reflector (optional)

FE-RR8

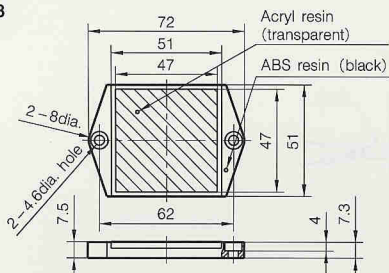

FE-RR15

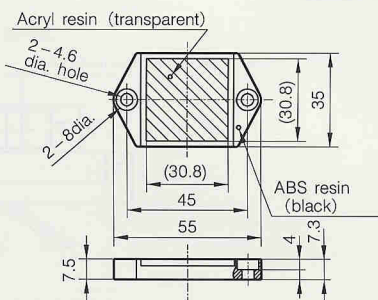

● Mounting bracket for horizontal model (included)

FE-PA8B1

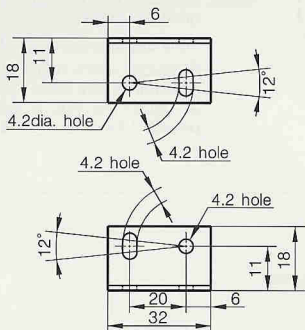

● Mounting bracket for vertical model (included)

FE-PA8B2

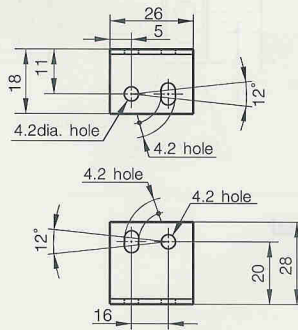

OUTPUT CIRCUIT DIAGRAMS

● Models with selectable operation mode

Emitters (except thru scan)

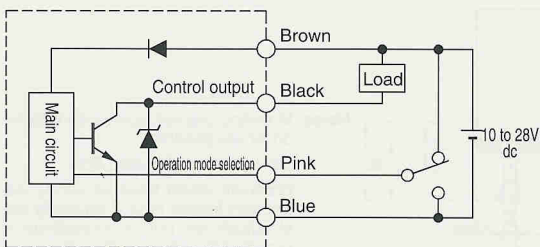

Thru scan emitter

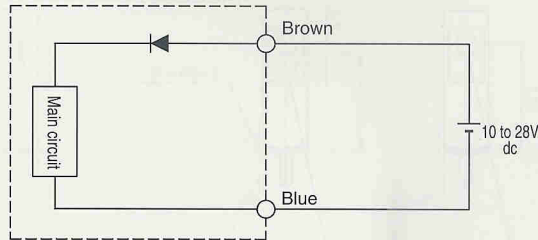

● Models with self-diagnostic output

Emitters (except thru scan)

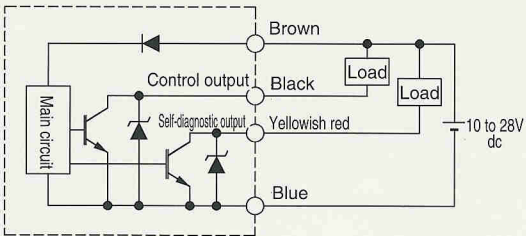

Thru scan emitter

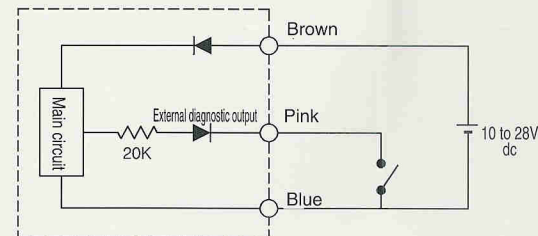

BASIC PRECAUTIONS**1. Optical axis adjustment for thru scan models and (polarized) retroreflective models**

Align the emitter and receiver (the main unit and the reflector for retroreflective models) vertically and horizontally in the center of the zone in which the indicator lights up.

2. Sensitivity adjustment for diffuse scan models

The scanning distance of diffuse scan models depends on the size, material, and reflectance of the target object. Adjust the sensitivity using the following procedure:

- (1) With no target object present, gradually lower the sensitivity from the maximum. The position where the indicator LED goes out is A. If the indicator does not light up even when the sensor is set to the maximum, the maximum position is A.
- (2) Introduce a target object and gradually raise the sensitivity from the minimum. The position where the indicator lights up is B.
- (3) Set the sensitivity at C, equidistant from A and B.

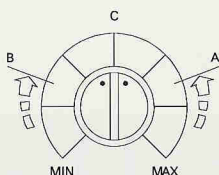

! Note: Do not turn up the sensitivity too far. If it is turned beyond the scale range, adjustment is impossible.

3. Handling

- Do not swing the photoelectric sensor by its cable.
- Do not pull the cable with too much force. The maximum pullout strength is 49N.
- Do not strike or scratch the lens or body.
- Do not expose to water or oil. Do not use outdoors or in an environment where chemicals are used (e.g., organic solvent, acid, alkali).
- Tighten connectors firmly by hand.
- The bend radius (R) of the cable is 30mm.

4. Wiring

- Do not put photoelectric sensor leads in the same conduit with high voltage or power cables. Surge and electrical noise can cause damage or malfunction.
- If extending the cable, use at least 0.3mm² wire. The length should not be over 100m.
- If a commercial switching regulator is used, ground its frame. Otherwise, switching noise may cause malfunction.
- If the load generates an inrush current (like a capacitive load or a lamp load), insert a current-limiting resistor between the load and the output. Otherwise the output short-circuit protection may be activated.

PHOTOELECTRIC SENSORS

MEASUREMENT SENSORS

PROXIMITY SENSORS

LIMIT SWITCHES

SAFETY INTERLOCK SWITCHES

BASIC SWITCHES

MANUAL SWITCHES

HP100

HPJ

HPA

HLA

HLB

FHDK10

FE8B

FE7D

HPV

FE8V

FE7W

DIE-CAST IP67 SEAL