

**DCP551 Mark II
Digital Control Programmer
User's Manual**



WARRANTY

The Honeywell device described herein has been manufactured and tested for correct operation and is warranted for a period of one year.

TECHNICAL ASSISTANCE

If you encounter a problem with your unit, please review all the configuration data to verify that your selections are consistent with your application; (i.e. Inputs, Outputs, Alarms, Limits, etc.). If the problem persists after checking the above parameters, you can get technical assistance by calling the following:

In the U.S.A. 1-800-423-9883

In Europe Your local branch office

Safety Precautions

■ About Symbols

Safety precautions are for ensuring safe and correct use of this product, and for preventing injury to the operator and other people or damage to property. You must observe these safety precautions, which are indicated by various symbols in this manual. Read the safety precautions first and make sure you understand them before you read the rest of the manual.

WARNING

Warnings indicate a situation which, if not avoided, could result in death or serious injury.

CAUTION

Cautions indicate a situation which, if not avoided or handled correctly, may result in injury or property damage.

■ Example of Symbols

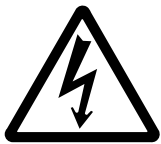

Equilateral triangles alert the user to a possible danger “WARNING” or “CAUTION” that may be caused by wrongful operation or misuse of this product. The symbol inside the triangle graphically represent the actual danger. (The example on the left warns the user of the danger of electric



White circles with a 45° slash angled downward from upper left to lower right notifies the user that specific actions are prohibited to prevent possible danger. The symbol inside the circle is a graphical representation of the actual prohibited action. (The example on the left notifies the user that disassembly is prohibited.)

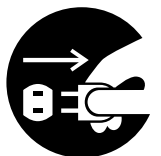

Black filled-in circles instruct the user to carry out a specific obligatory action to prevent possible danger. The symbol inside the circle is a graphical representation of the actual action to be carried out. (The example on the left instructs the user to remove the plug from the outlet.)

WARNING



Be sure to turn off the power supply when you are installing or removing the controller.
Failure to heed this warning may lead to electric shock.



Do not disassemble the controller as this could lead to electric shock or malfunction.



Connect the FG terminal to ground with a ground resistance of maximum 100 before connecting other equipment and external control circuits.
Failure to do so may cause electric shock or fire.



Be sure to turn off the power supply when you connect the controller.
Failure to do so may lead to electric shock or fire.



Do not touch a live part such as a power terminal.
This may result in electric shock.

CAUTION



Be sure to follow the operating requirements (regarding temperature, humidity, voltage, vibration, shock, mounting direction, atmosphere, etc.) as stated in the specifications of the controller.
Failure to heed this caution may lead to fire or malfunction.



Do not block ventilation openings.
Failure to heed this caution may lead to fire or malfunction.



Make sure that wire scraps, chips or water do not enter inside the case of the controller.
Failure to heed this caution may lead to fire or malfunction.



Do not use pointed objects such as mechanical pencils or pins to press the keys on the controller.
This may result in malfunction.



Connect the controller as specified using designated cables and connection procedures.
Failure to heed this caution may lead to electric shock, fire or malfunction.



Current applied to current input terminals (55), (56) and (58), (59) must meet the specified range.
Failure to heed this caution may lead to fire or equipment breakdown.



All terminal screws shall be tightened to specified torque.
Improperly tightened screws may lead to electric shock or fire.

CAUTION



Do not use unused terminals on the instrument as relay terminals for other equipment. Failure to heed this caution may lead to electric shock, fire or equipment breakdown.



Attaching the terminal covers after completing the controller connections is highly recommended. Failure to heed this caution may lead to fire or malfunction. (Terminal covers are supplied with the controller.)



Use induced lighting surge preventive device Non if there is a risk of power surges caused by lighting. Failure to do so may cause fire or malfunction.



Be sure to turn off the power supply when you are replacing the batteries. Failure to heed this warning may lead to electric shock.



Be sure not to touch internal components during battery replacement or just after the power has been turned. This may result in burn injuries.



- Make sure that the batteries are inserted with the plus(+) and minus(-) poles correctly oriented.
- Do not use damaged batteries or batteries that leak.
- Do not throw batteries into a fire, recharge, disassemble or expose them to heat.
- Store batteries in a cool, dry place.

Failure to heed these cautions may result in burns or battery leakage.



Batteries should be kept out of reach of children, since they may swallow them. Should a child swallow a battery, contact a doctor immediately.



When disposing of used batteries at the user site, observe local bylaws.



Before you touch internal components, be sure to discharge any static electricity on your body by touching a metal ground connector. Failure to heed this caution may lead to equipment damage.

HANDLING PRECAUTIONS

After turning on the DCP551 mark II, leave it for at least 10 seconds to let it stabilize before you start using it.



Unpacking

Check the following when removing the DCP551 from its package.

1. Check the model No. to make sure that you have received the product that you ordered.
2. Check the DCP551 for any apparent physical damage.
3. Check the contents of the package against the Package List to make sure that all accessories are included in the package.

After unpacking, handle the DCP551 and its accessories taking care to prevent damage or loss of parts.

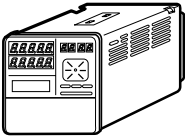
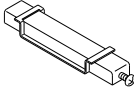
If an inconsistency is found or the package contents are not in order, immediately contact your dealer.

Name	Model No.	Q'ty	Remarks
Body 		1	See 1-5 Model Number Configuration, page 1-5.
Mounting bracket 	81446044-001	1set (2pcs.)	
User's Manual 	EN11-6186 (CP-UM-5024E)	1	This manual
Engineering unit indicator label		1	
Terminal cover 	81446176-001	1	Power supply terminal cover

Organization of This User's Manual

This manual is organized as follows.

Chapter 1. PRODUCT OUTLINE

This chapter gives this product uses, characteristic, basic function block and this product model numbers.

Chapter 2. NAMES AND FUNCTIONS OF PARTS

This chapter gives the names and functions of parts of this product, and input type and range number.

Chapter 3. INSTALLATION AND MOUNTING

This chapter describes the mounting procedure for this product to the operation panel. We strongly urge persons responsible for device design on the DCP551 read this chapter.

Chapter 4. WIRING

This chapter describes the wiring procedure and precautions required for installing this product.

We strongly urge persons responsible for device design and wire on the DCP551 read this chapter.

Chapter 5. FUNCTIONS

This chapter explains detailed functions of this product.

We strongly urge persons responsible for control design on the DCP551 read this chapter.

Chapter 6. OPERATION

This chapter gives the selections of the basic display, program selection, operation, and others.

We strongly urge persons responsible for device design and operation on the DCP551 read this chapter.

Chapter 7. PARAMETER SETUP

This chapter gives the parameter setting method to this product and the meaning of a setting.

Chapter 8. PROGRAM SETUP

This chapter gives the program setting method to this product and the meaning of a setting.

Chapter 9. MEMORY CARD OPERATION

This chapter gives the using method to this product.

Chapter 10. TROUBLESHOOTING

This chapter describes checkpoints and countermeasures when this product is not operating normally.

Chapter 11. SPECIFICATIONS

This chapter gives the general specifications, performance specifications and the external dimensions of this product.

Chapter 12. CALIBRATION

This chapter describes calibration procedures for the functions of the DCP551.

Contents

Safety Precautions

Unpacking

Organization of This User's Manual

Conventions Used in This Manual

Chapter 1. PRODUCT OUTLINE

1-1	Features.....	1-1
1-2	Basic Function Block Diagram.....	1-2
1-3	Data Configuration Overview.....	1-3
1-4	System Configuration.....	1-4
	■ CPL communications network-based configuration.....	1-4
1-5	Model Number.....	1-5

Chapter 2. NAMES AND FUNCTIONS OF PARTS

2-1	Structure.....	2-1
2-2	Console.....	2-2
	■ Basic display status.....	2-2
	■ Display.....	2-2
	■ Key pad.....	2-4
	■ Key chord functions.....	2-6
	■ Loader jack.....	2-7
2-3	Input Type and Range Number.....	2-8
	■ Input.....	2-8

Chapter 3. INSTALLATION AND MOUNTING

3-1	Before Installation.....	3-1
	■ Mounting position.....	3-1
	■ Sources of electrical interference and countermeasures.....	3-2
	■ Dust proof cover.....	3-2
3-2	Installation.....	3-3
	■ Panel cutout dimension.....	3-3
	■ Installation procedures.....	3-4

Chapter 4. WIRING

4-1	Precautions on Wiring.....	4-1
4-2	Recommended Cables.....	4-3
4-3	Making Terminal Connections.....	4-4
4-4	Terminal Array.....	4-5
4-5	Power Supply and Grounding.....	4-6
	■ Power supply.....	4-6
	■ Grounding.....	4-6
4-6	PV Input (Analog Input) Connection.....	4-7
	■ PV input CH1 connection.....	4-7
	■ PV input CH2 connection.....	4-7

4-7	Control Output Connection	4-9
	■ Current output	4-9
	■ Voltage output	4-9
	■ Open collector output	4-9
4-8	Auxiliary Output (Output CH1, CH2) Connection.....	4-10
	■ Auxiliary output CH1 connection	4-10
	■ Auxiliary output CH2 connection	4-10
4-9	Event Output (Open Collector Output) Connection.....	4-11
4-10	External Switch Input Connection	4-12
4-11	Communication Connection.....	4-13
	■ RS-485 connection.....	4-13
	■ RS-232C connection	4-16
	■ Connection to ST221	4-17
4-12	Isolation Between Input and Output.....	4-18

Chapter 5. FUNCTIONS

5-1	Data	5-1
	■ Data types	5-1
5-2	Program Pattern.....	5-2
	■ Pattern.....	5-2
	■ Events	5-5
	■ PID group selection.....	5-16
	■ Selection of output limiter group.....	5-16
	■ G.SOAK (Guarantee soak)	5-17
	■ PV shift.....	5-18
	■ Repeat.....	5-19
	■ PV start	5-20
	■ Cycle	5-21
	■ Pattern link	5-22
	■ Tag.....	5-23
5-3	Mode.....	5-24
	■ Mode types.....	5-24
	■ Mode transitions.....	5-26
	■ Mode transition operations.....	5-27
	■ Mode transition restrictions	5-28
5-4	Controllers and programmers	5-29
5-5	Input Process Functions	5-30
	■ PV input 1 channel model	5-30
	■ PV input 2 channel model	5-31
	■ Channel switching (PV input 2 channel model).....	5-32
5-6	Output Processing Functions.....	5-37
	■ Control output.....	5-37
	■ SP output	5-39
	■ Auxiliary output.....	5-39

Chapter 6. OPERATION

6-1	Power Supply On	6-1
6-2	Basic Display Selection.....	6-2
	■ Program run mode displays	6-3
	■ Constant value control mode	6-6
6-3	Selecting Programs.....	6-7
	■ Selecting program numbers	6-7
6-4	External Switch Operation	6-8
	■ External switch input	6-8
	■ Selecting programs	6-9
	■ Read timing	6-11
6-5	Manual Operation and Auto-Tuning.....	6-12
	■ Manual operation	6-12
	■ Auto-tuning (AT)	6-12

Chapter 7. PARAMETER SETUP

7-1	Parameter Setup	7-1
	■ Selecting parameter settings groups.....	7-1
	■ Progression of individual items in parameter settings.....	7-1
	■ Modifying individual items and exiting the setting mode	7-2
7-2	Parameter Setting List	7-4
	■ Variable parameter setting	7-5
	■ Detailed information on variable parameters	7-9
	■ Event configuration data settings	7-12
	■ Settings by event type.....	7-13
	■ PID parameter setting	7-18
	■ Setup data setting	7-21
	■ Detailed descriptions of setup data settings.....	7-28
	■ Constant value control data setting.....	7-33

Chapter 8. PROGRAM SETUP

8-1	Program Setup	8-1
	■ Selecting number of program to operate.....	8-1
	■ Starting programming.....	8-2
	■ State transition	8-2
	■ Programming map.....	8-4
	■ Display items	8-5
	■ Setting pattern items	8-5
	■ Setting event items.....	8-7
	■ Setting PID groups and output limiter group number items	8-12
	■ Setting G.SOAK (Guarantee soak) items.....	8-13
	■ Setting PV shift items	8-14
	■ Setting repeat items	8-15
	■ Setting PV start items.....	8-16
	■ Setting cycle items	8-17
	■ Setting pattern link items.....	8-18

■ Setting tag items	8-19
■ Deleting programs	8-20
■ Inserting and deleting segments	8-21
8-2 Copying Programs	8-23
■ Program copy procedures	8-23
8-3 General Reset	8-24
■ General reset procedures	8-24

Chapter 9. MEMORY CARD OPERATIONS

9-1 Memory Card Type and Functions	9-1
9-2 Save Procedures	9-2
■ Save menu	9-2
■ Procedures for formatting cards	9-3
■ Procedures for saving single programs	9-3
■ Procedures for saving all programs	9-4
■ Procedures for saving setup data	9-4
■ Procedures for saving variable parameters	9-4
■ Procedures for saving PID parameters	9-5
■ Procedures for saving event configuration data	9-5
■ Procedures for saving all parameters	9-5
9-3 Load Procedures	9-6
■ Load menu	9-6
■ Card battery alarm panel	9-7
■ Procedures for loading individual programs	9-7
■ Procedures for loading all programs	9-8
■ Procedures for loading setup data	9-8
■ Procedures for loading variable parameters	9-8
■ Procedures for loading PID parameters	9-8
■ Procedures for loading event configuration data	9-9
■ Procedures for loading all parameters	9-9
9-4 Autoload	9-10
■ key operated autoload procedure	9-10
■ Auto load using external switch inputs	9-11
9-5 Error Message List	9-12

Chapter 10. TROUBLESHOOTING

10-1 Self-Diagnostic Functions and Alarm Code Displays	10-1
■ Power ON self-diagnostic routines	10-1
■ Self-diagnostic routines performed each sampling cycle	10-1
■ Self-diagnostic routines performed continuously during operation	10-1
■ Alarm code display	10-2
■ Alarm classification	10-2
10-2 Key Input Related Problems	10-3
■ Normal display mode problems	10-3
■ Parameter setting related problems	10-6
■ Program setting related problems	10-6

10-3 When the BAT LED Flashes	10-8
■ BAT LED flashes	10-8
■ Replacing the battery	10-8

Chapter 11. SPECIFICATIONS

11-1 Specifications	11-1
■ Attachment/auxiliary devices list	11-7
11-2 External Dimensions	11-8
■ DCP551	11-8
■ Soft dust-proof cover set (option)	11-8

Chapter 12. CALIBRATION

■ Precautions before calibration	12-1
■ Equipment needed	12-1
12-1 Quick Reference Table for Calibration Items	12-2
12-2 Calibration Procedures	12-7
■ Enter calibration mode	12-7
■ Function test	12-8
■ PV calibration	12-11
■ Cold junction sensor calibration	12-14
■ Current output calibration	12-15
12-3 Set Up	12-17

Program Work Sheet

Parameter Work Sheet

SAFETY REQUIREMENTS

Conventions Used in This Manual

The following conventions are used in this manual.

 **HANDLING PRECAUTIONS**

: HANDLING PRECAUTIONS indicate items that the user should pay attention to when handling the DCP551.

 **NOTE**

: Notes indicate useful information that the user might benefit by knowing.

(1), (2), (3)

: The numbers with the parenthesis indicate steps in a sequence or indicate corresponding parts in an explanation.

>>

: Controller state after an operation

DISP key, **↑ key** : Indicate this product's keys. These icons represent keys on the DCP551's console.

FUNC+PROG key : Combinations of icons like this indicate that **PROG key** must be pressed while holding **FUNC key** down.

PA01, **C21**

: Indicate the 7 segments display of display panel 1 and display panel 2 on this product.

PV SHIFT

: Indicates the display of the message display on this product.

Chapter 1. PRODUCT OUTLINE

1-1 Features

The DCP551 is a general purpose single-loop control programmer for controlling temperature, pressure, flow rate and other parameters. The program provides a total of 99 patterns and up to 99 segments can be set for each pattern. Note, however, that the maximum number of segments is 2000 or less and that the maximum number of subfunctions for setting events is 4000 or less.

- **High accuracy in multi-range inputs**

Featuring a multi-range format, the user can select thermocouple, resistance temperature detector, DC voltage or DC current. Accuracy is $\pm 0.1\%$ FS ± 1 digit, the sampling cycles is 0.1 sec and some model numbers allow PV2 channel switching.

- **Multi-control output types**

Selection at setup allows the user to choose from among current proportional setting output, current proportional output, voltage time proportional output and open collector time proportional output.

- **Multi-communications**

Selection at setup enables the user to switch between RS-485 and RS-232C on the rear panel terminal base.

At setup it is also possible to switch the communications port from the rear panel terminal base to the front panel loader jack. A special cable is required to use to loader jack on the front panel.

- **Improved PLC support**

The programmer is equipped with 16 external switch inputs and 16 event outputs for flexible support of PLC based automatic systems.

- **Simple operation**

The optional plug-in memory card makes it easy to achieve program and parameter settings for later reuse. Also, the optional smart loader package allows you to make program and parameter settings from a PC.

1-2 Basic Function Block Diagram

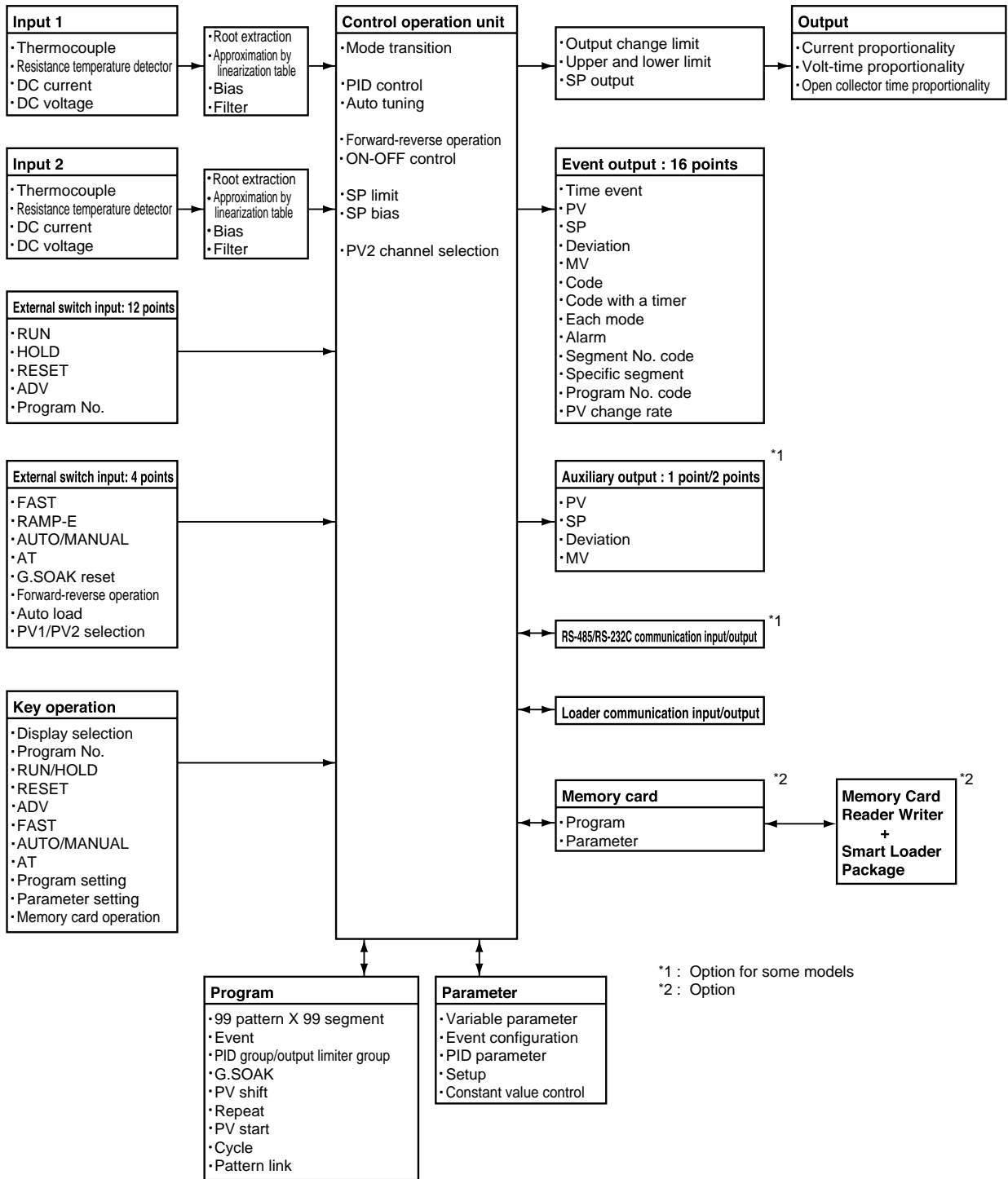

1-3 Data Configuration Overview

Data is comprised of parameters and the program.

Parameters are used to set the functions of the DCP551 while the program is the software that operates the controller at run time.

● **A total of 99 patterns**

The program can record up to 99 patterns.

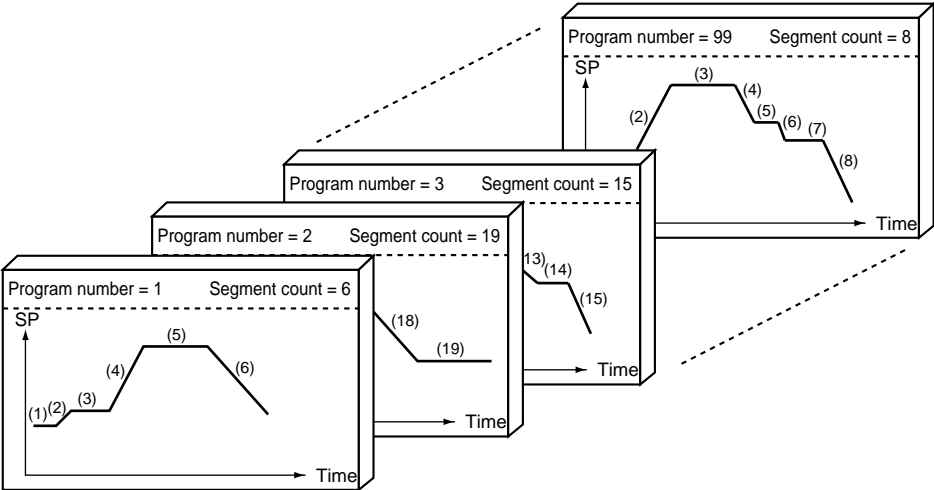

● **Parameters**

Five types of patterns are provided: variable parameters, event configuration data, PID parameters, setup data and constant value control data.

Variable parameter
Event configuration data
PID parameter
Setup data
Constant value control data

1-4 System Configuration

■ CPL communications network-based configuration

Models equipped with the optional communications interface can be connected as a slaved controller to a communications network. In this case, the user can employ as the master station a personal Computer.

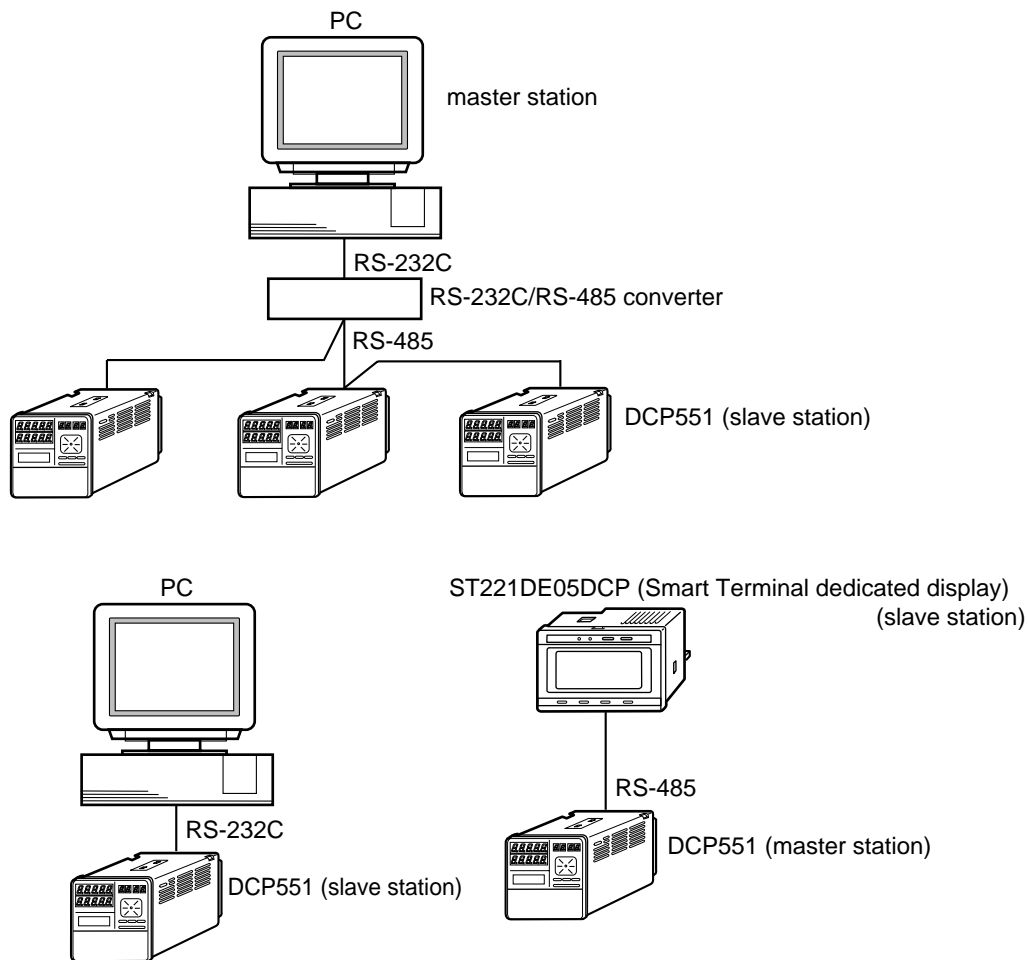

1-5 Model Number

Model number : DCP551E□0□□□

Basic model number		PV input count	Additional number	Option	Additional processing	Contents
DCP551						Digital programmable controller (1-roop control)
	E					Mark II
		1				PV input 1 channel
		2				PV input 2 channel
			0			Fixed 0
				0		Not provided
				1		Auxiliary output 1 channel
				2		Auxiliary output 2 channel, communication
					00	Not provided

Chapter 2. NAMES AND FUNCTIONS OF PARTS

2-1 Structure

The DCP551 consists of a main unit, console, case, and terminal base.

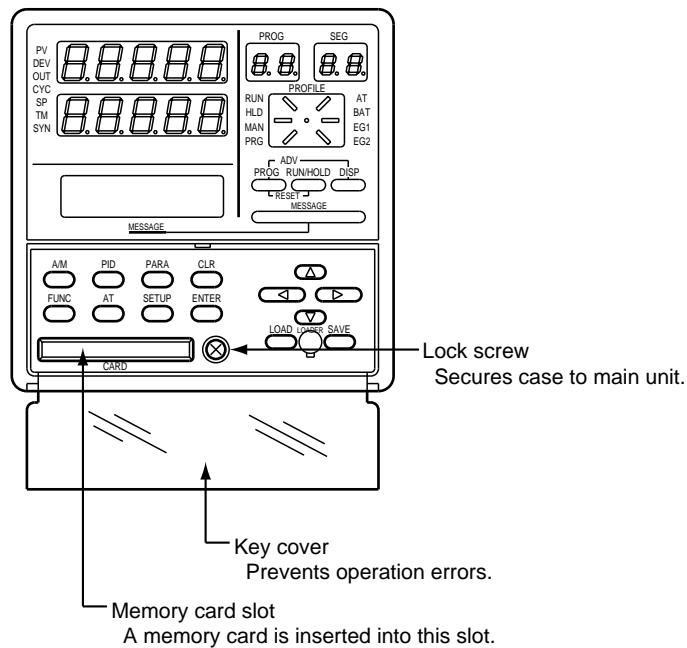
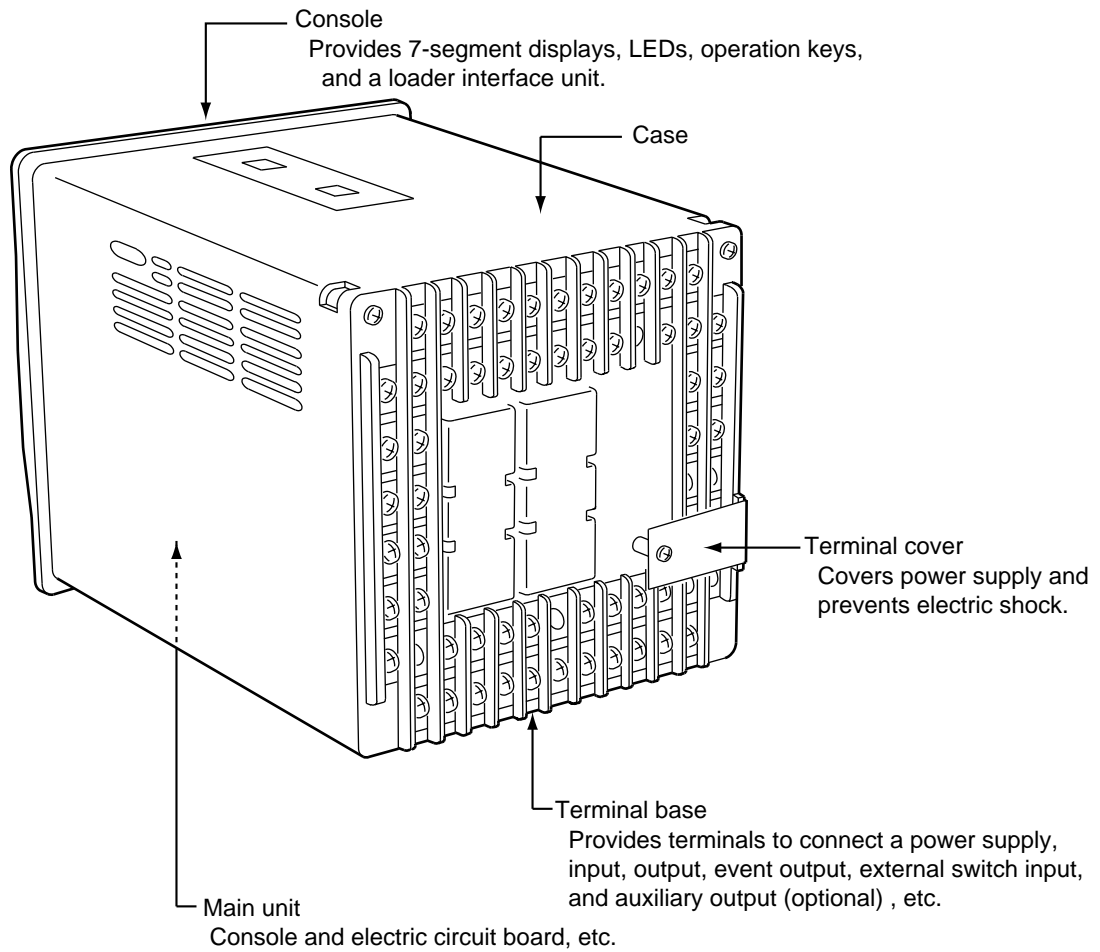

2-2 Console

The console consists of the operation keys, displays and LEDs (light emitting diodes).

■ Basic display status

Basic display status shows the running condition of the DCP551 on the console. The basic display status is invoked when the DCP551 is powered up (power on). Key operations make it possible to change from the basic display status to parameter setting status, program setting status, program copy status, memory card operation status and general reset status.

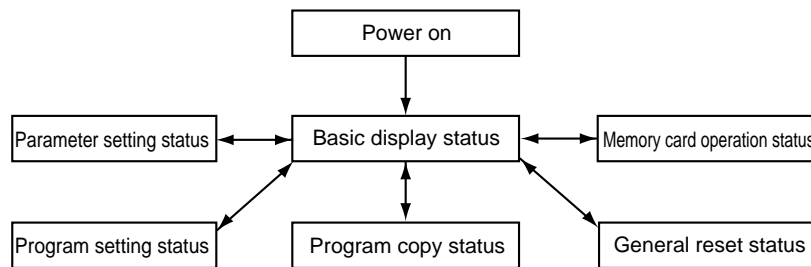

Key operations can also be used to return to the basic display status.

■ Display

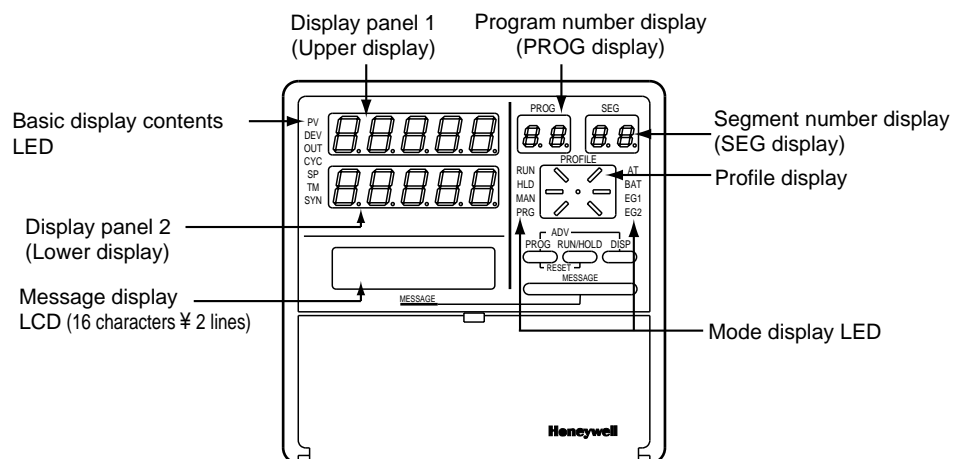

● Basic display contents LED

- PV : Lights during PV display, otherwise off.
- DEV : Lights during deviation display, otherwise off.
- OUT : Lights during output display, otherwise off.
- CYC : Lights during cycle display, otherwise off.
- SP : Lights during SP display, otherwise off.
- TM : Lights during time display, otherwise off.
- SYN : Off

- **Display panel 1**

Indicates PV and other data in basic display status.

Indicates item codes in parameter setting status.

Indicates set values and item codes in program setting status.

- **Display panel 2**

Indicates SP, time, output and other data in basic display status.

Indicates set values in parameter setting status.

Indicates set values in program setting status.

- **Message display**

Indicates output graph, deviation graph, running progress graph, event status, program tag and other data in basic display status.

Displays reference messages in parameter setting status.

Displays tag settings and reference messages in program setting status.

Indicates selected operation and operation results during memory card operation.

- **Program number display**

Indicates a selected program number in basic display status.

Indicates a set program number in program setting status.

Off during constant value control.

Indicates the alarm code "**AL**" when an alarm occurs in basic display status.

- **Segment number display**

Indicates a selected segment number in basic display status.

Indicates a set segment number in program setting status.

Off during constant value control.

Indicates an alarm code number when an alarm occurs in basic display status.

- **Mode display LED**

RUN, HLD : Indicates the RUN, HOLD, FAST, END, and READY FAST modes (see the table below).

LED \ Mode	READY	RUN	HOLD	FAST	END	READY FAST
RUN	OFF	Lights	OFF	Flicker	OFF	Lights
HLD	OFF	OFF	Lights	OFF	Flickers	Lights

MAN : Lights in MANUAL mode. Off in AUTO mode.

PRG : Lights in program setting status, otherwise off.

AT : Flickers during auto tuning execution, otherwise off.

BAT : Flickers when battery voltage is too low, otherwise off.

EG1, EG2 : Lights when an event number output set by **PA41** or **PA42** is set to ON setting. Off when set to OFF.

- **Profile display**

Indicates the rising, soaking, and falling trends of a program pattern.

Flickers during G.SOAK wait and lights continuously after power on.

■ Key pad

! CAUTION



Do not use pointed objects such as mechanical pencils or pins to press the keys on the controller. This may result in malfunction.

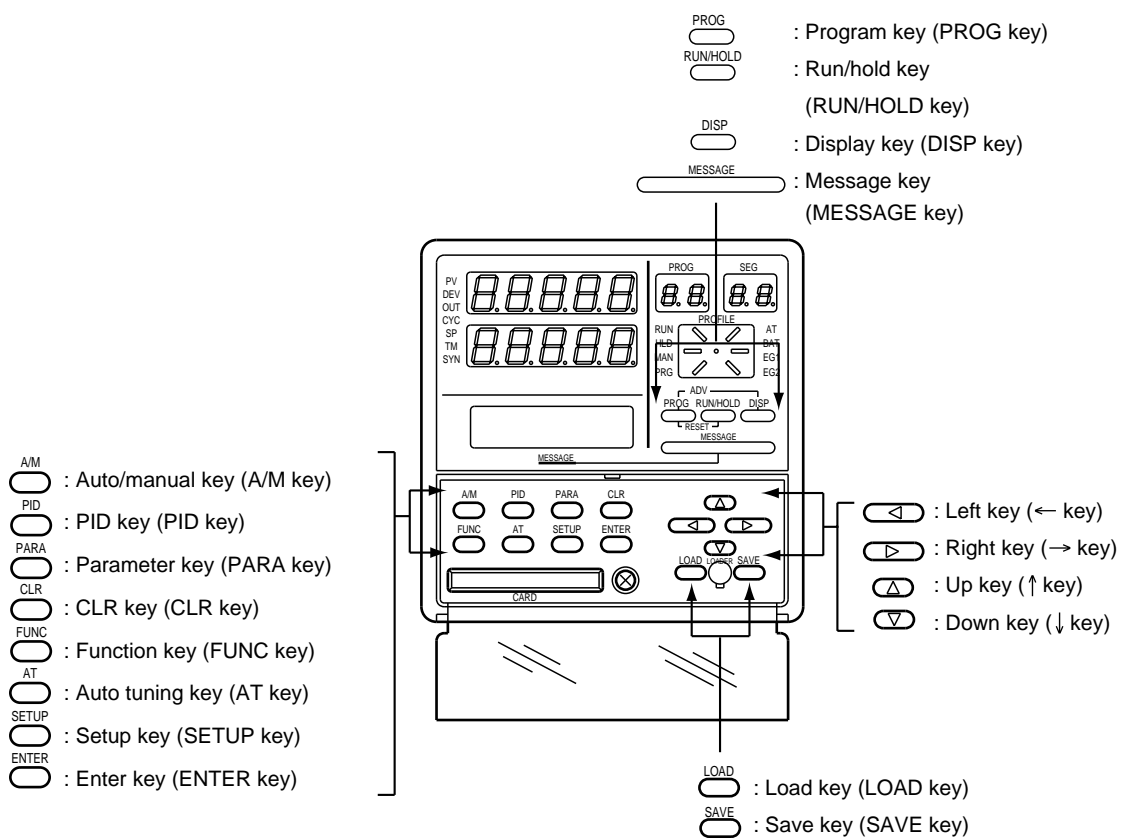

() : Denotes key term used in this manual.

Classification	Function	Key operation
Basic display status	Changes the display contents.	DISP
	Changes the display contents on the message display.	MESSAGE
	Changes set program numbers in ascending order. (In READY mode)	PROG
	Performs RUN operation. (In READY, HOLD, FAST, or READY FAST mode)	RUN/HOLD
	Performs HOLD operation. (In RUN mode)	
	Performs RESET operation. (In RUN, HOLD, FAST, END, or READY FAST mode)	PROG + RUN/HOLD
	Performs ADV operation. (In RUN, HOLD, FAST, or READY FAST mode)	PROG + DISP
	Performs FAST operation. (In RUN, HOLD, or READY mode)	FUNC + →
	Performs MANUAL operation. (In AUTO mode)	A/M
	Performs AUTO operation. (In MANUAL mode)	
	Starts auto tuning. (When auto tuning is not in operation.)	AT
	Interrupts auto tuning (When auto tuning is in operation.)	
	Changes numerics during MANUAL operation. (When the MV or SV display flickers.)	↑ ↓ ← →
	Changes program numbers or segment numbers. (When the program number or segment number flickers.)	
Parameter setting	Starts the variable parameter setting. (In basic display status)	PARA
	Starts the event configuration setting. (In basic display status)	FUNC + PARA
	Starts the PID parameter setting. (In basic display status)	PID
	Starts the setup setting. (In basic display status)	SETUP
	Starts the constant value control setting. (In basic display status)	FUNC + PID
	Shifts each item.	↑ ↓ ← →
	Enters set values.	
	Completes a change in a set value. (When a set value flickers.)	↑ ↓ ← →
	Changes each item's set point. (When a set value flickers.)	
	Stops each item's set point. (When a set value flickers.)	
	Ends parameter setting.	DISP
Program setting	Starts the program setting (programming). (In basic display status)	FUNC + PROG
	Shifts to program item or segment number.	↑ ↓ ← →
	Enters set values.	
	Completes a change in a set values. (When a set value flickers.)	↑ ↓ ← →
	Changes each item's set point. (When a set value flickers.)	

Classification	Function	Key operation
Program setting	Erases or resets a set value. (When a set value flickers.)	FUNC + CLR
	Cancels change in set value. (When a set value flickers.)	DISP
	Inserts or delete a segment when a pattern SP setting is started.	FUNC + ENTER
	Changes RAMP-X ↔ RAMP-T or RAMP-X ↔ RAMP-E when a pattern SP setting is completed.	
	Starts a program number change.	FUNC + PROG
	Ends program setting.	DISP
Program copy	Starts program copy. (In basic display status)	↑ + PROG
	Changes program number at copy destination.	↑ ↓
	Executes the copy. (When a set value flickers.)	ENTER
	Ends program copy.	DISP
Memory card operation	Starts a data write operation to the memory card. (In basic display status)	SAVE
	Writes data to the memory card.	
	Starts a data read operation from the memory card. (In basic display status)	LOAD
	Reads data from the memory card.	
	Changes selected memory card operation.	↑ ↓
	Enters memory card operation.	ENTER
	Interrupts memory card operation.	DISP
General reset	Returns a check status of the general reset. (In basic display status)	FUNC + CLR + MESSAGE
	Executes a general reset.	ENTER
	Interrupts a general reset.	DISP

■ Key chord functions

PROG + RUN/HOLD : Reset key

Press the **RUN/HOLD key** while holding down the **PROG key** in basic status display to perform a RESET.

The READY mode is invoked when a reset is performed in the RUN, HOLD, FAST, END, or READY FAST modes. This RESET operation does not work in the READY mode.

PROG + DISP : Advance key

Press the **DISP key** while holding down the **PROG key** in the program run mode in basic status display to perform an ADV (advance) operation. The next segment is displayed when this action is performed in the RUN, HOLD, FAST, END, or READY FAST modes. This ADV operation does not work in the READY mode.

FUNC + → : Fast key

Press the **→ key** while holding down the **FUNC key** in the program run mode in basic status display to perform a FAST operation.

The system changes from the RUN or HOLD mode to the FAST mode. If the system is in the READY mode, it goes to the READY FAST mode.

-
- FUNC + PARA** : Event configuration setting key
Press the **PARA key** while holding down the **FUNC key** in basic status display to switch to the event configuration setting status.
- FUNC + PID** : Constant value control setting key
Press the **PID key** while holding down the **FUNC key** in basic status display to switch to the event configuration setting status.
- FUNC + PROG** : Program setting (programming) key
Press the **PROG key** while holding down the **FUNC key** in the program run mode in basic status display to go to the program setting (programming) status.
When the **PROG key** is pressed while holding down the **FUNC key** in the program setting status, allows you to change the number of the program to be set.
- FUNC + CLR** : Program delete key
Press the **CLR key** while holding down the **FUNC key** during registration in the program setting status to delete a setting or return to a default value.
- FUNC + ENTER** : Segment insert/remove/RAMP/selection key
Press the **ENTER key** while holding down the **FUNC key** to go to the segment insert/delete panel during SP and time setting in the program setting status.
Pressing the **ENTER key** while the **FUNC key** is held down during SP registration in the program setting status allows you to switch between RAMP-X and RAMP-T as well as RAMP-X and RAMP-E.
- ↑ + PROG** : Program copy key
Press the **PROG key** while holding down the **↑ key** in program run READY mode in basic display status to go to the program copy panel.
- FUNC + CLR + MESSAGE** : General reset key
Press the **CLR** and **MESSAGE keys** simultaneously while holding down the **FUNC key** in the READY AUTO mode in the basic display status to go to the general reset verification panel.

■ Loader jack

This jack allows the connection of a loader.
Do not insert plugs other than loader plugs.
The loader jack is not isolated from internal digital circuits.
When not in use, always replace the cap.

2-3 Input Type and Range Number

■ Input

● Thermocouple

Input type			Input range (FS)		Accuracy (under standard conditions)	
Symbol	Code	Range No.	°C	°F		
K (CA)	K46	16	-200.0 to +200.0	-300.0 to +400.0	±0.1%FS	
K (CA)	K09	0	0.0 to 1200.0	0 to 2400	±0.1%FS	
K (CA)	K08	1	0.0 to 800.0	0 to 1600	±0.1%FS	
K (CA)	K04	2	0.0 to 400.0	0 to 750	±0.1%FS	
E (CRC)	E08	3	0.0 to 800.0	0 to 1800	±0.1%FS	
J (IC)	J08	4	0.0 to 800.0	0 to 1600	±0.1%FS	
T (CC)	T44	5	-200.0 to +300.0	-300 to +700	±0.1%FS	±0.3%FS at -200 to -45°C
B (PR13)	B18	6	0.0 to 1800.0	0 to 3300	±0.1%FS	±4.0%FS at 0 to 260°C, ±0.15%FS at 260 to 800°C
R (RR13)	R16	7	0.0 to 1600.0	0 to 3100	±0.1%FS	
S (PR10)	S16	8	0.0 to 1600.0	0 to 3100	±0.1%FS	
W (WRe5-26)	W23	9	0.0 to 2300.0	0 to 4200	±0.1%FS	
W (WRe5-26)	W14	10	0.0 to 1400.0	0 to 2552	±0.1%FS	
PR40-20	D19	11	0.0 to 1900.0	0 to 3400	±0.2%FS	±0.9%FS at 0 to 300°C, ±0.5%FS at 300 to 800°C
N	U13	12	0.0 to 1300.0	32 to 2372	±0.1%FS	
PL II	Y13	13	0.0 to 1300.0	32 to 2372	±0.1%FS	
Ni-Ni • Mo	Z13	14	0.0 to 1300.0	32 to 2372	±0.1%FS	
Gold, iron, chromel	Z06	15	0.0 to 300.0K (K : Kelvin)		±0.4%FS	

● Resistance temperature detector (RTD)

Input type			Input range (FS)		Accuracy (under standard conditions)	
Symbol	Code	Range No.	°C	°F		
JIS'89Pt100 (IEC Pt100 Ω)	F50	64	-200.0 to +500.0	-300.0 to +900.0	±0.1%FS	
	F46	65	-200.0 to +200.0	-300.0 to +400.0	±0.1%FS	
	F32	66	-100.0 to +150.0	-150.0 to +300.0	±0.1%FS	
	F36	67	-50.0 to +200.0	-50.0 to +400.0	±0.1%FS	
	F33	68	-40.0 to +60.0	-40.0 to +140.0	±0.15%FS	
	F01	69	0.0 to 100.0	0.0 to 200.0	±0.15%FS	
	F03	70	0.0 to 300.0	0.0 to 500.0	±0.1%FS	
	F05	71	0.0 to 500.0	0.0 to 900.0	±0.1%FS	
JIS'89Pt100	P50	96	-200.0 to +500.0	-300.0 to +900.0	±0.1%FS	
	P46	97	-200.0 to +200.0	-300.0 to +400.0	±0.1%FS	
	P32	98	-100.0 to +150.0	-150.0 to +300.0	±0.1%FS	
	P36	99	-50.0 to +200.0	-50.0 to +400.0	±0.1%FS	
	P33	100	-40.0 to +60.0	-40.0 to +140.0	±0.15%FS	
	P01	101	0.0 to 100.0	0.0 to 200.0	±0.15%FS	
	P03	102	0.0 to 300.0	0.0 to 500.0	±0.1%FS	
	P05	103	0.0 to 500.0	0.0 to 900.0	±0.1%FS	

●DC current, DC voltage

Input type			Input range (FS)		Accuracy (under standard conditions)	
Symbol	Code	Range No.				
mA (Linear)	C01	48	4 to 20mA	Programmable range -19999 to +20000 (Decimal point position is variable.)	±0.1%FS	
	Z51	52	2.4 to 20mA		±0.1%FS	
mV	M01	49	0 to 10mV		±0.1%FS	
	L02	50	-10 to +10mV		±0.1%FS	
		51	0 to 100mV		±0.1%FS	
mA (Linear)	C01	128	4 to 20mA		±0.1%FS	
	Z51	134	2.4 to 20mA		±0.1%FS	
V (Linear)		129	0 to 1V		±0.1%FS	
		130	-1 to +1V		±0.1%FS	
	V01	131	1 to 5V		±0.1%FS	
		132	0 to 5V	±0.1%FS		
		133	0 to 10V	±0.1%FS		

! HANDLING PRECAUTIONS

- The unit for code Z06 is "K" (kelvin).
- Code F50 and P50 do not generate the PV lower bound alarm.
- The number of decimal digits for DC current and DC voltage is programmable from 0 to 4.

Chapter 3. INSTALLATION AND MOUNTING

3-1 Before Installation

WARNING



Be sure to turn off the power supply when you are installing or removing the controller.

Failure to heed this warning may lead to electric shock.



Do not disassemble the controller as this could lead to electric shock or malfunction.

CAUTION



Be sure to follow the operating requirements (regarding temperature, humidity, voltage, vibration, shock, mounting direction, atmosphere, etc.) as stated in the specifications of the controller.

Failure to heed this caution may lead to fire or malfunction.



Do not block ventilation openings.

Failure to heed this caution may lead to fire or malfunction.



Make sure that wire scraps, chips, or water do not enter inside the case of the controller.

Failure to heed this caution may lead to fire or malfunction.

■ Mounting position

Do not install the DCP551 in locations:

- exposed to high or low temperature or humidity.
- exposed to direct sunlight or to the elements such as outside.
- exposed to water, oil or chemicals.
- exposed to corrosive or inflammable gas.
- exposed to dust or smoke.
- exposed to vibrations or shocks.
- exposed to strong electric or magnetic fields.
- exposed to electric noise such as ignition devices or welding machines.

■ Sources of electrical interference and countermeasures

- The following noise generation sources are generally presumable.
 - (1) Relays and contacts
 - (2) Solenoid coils and valves
 - (3) Power lines (especially those carrying more than 90VAC)
 - (4) Inductive loads
 - (5) Inverters
 - (6) Motor rectifiers
 - (7) Phase angle control SCR
 - (8) Wireless communications equipment
 - (9) Welding machines
 - (10) High voltage ignition devices
- If the source of noise cannot be removed, take the following measures.
 - Use a CR filter to suppress fast-rising noise.
Recommended CR filter: No. 81446365-001
 - Use a varistor to suppress high-amplitude interference.
Recommended varistors:
No. 81446366-001 (for 110 to 120V)
81446367-001 (for 200 to 240V)

HANDLING PRECAUTIONS

Varistors must be handled carefully as they become defective if they are short-circuited.

■ Dust proof cover

Use the soft dust proof cover when the DCP551 is used in locations where there is a lot of dust.

3-2 Installation

This section describes installation procedures.

■ Panel cutout dimension

Use 2mm thick steel panels in setting up the DCP551.

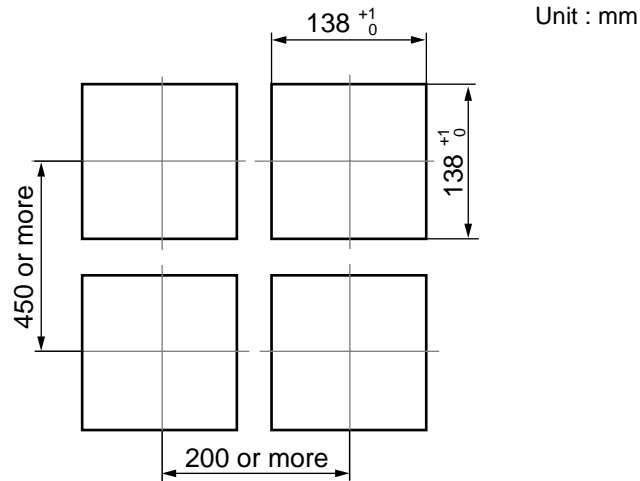

! HANDLING PRECAUTIONS

Install the DCP551 in a location where the lower panel is not exposed to temperatures that exceed the operating temperature range (0 to 50°C). Make sure that the temperatures above and below the controller meet specified requirements.

■ Installation procedures

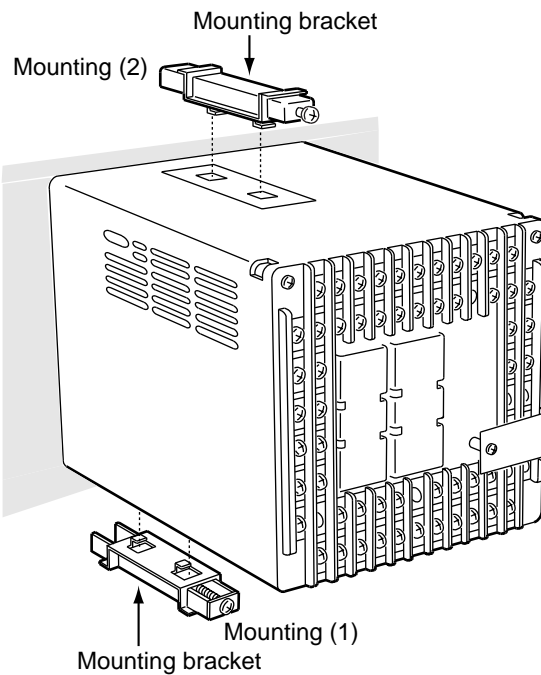

- Use the provided mounting bracket to firmly secure the upper and lower panels.
- Assemble the instrument before carrying out mounting (1).

! HANDLING PRECAUTIONS



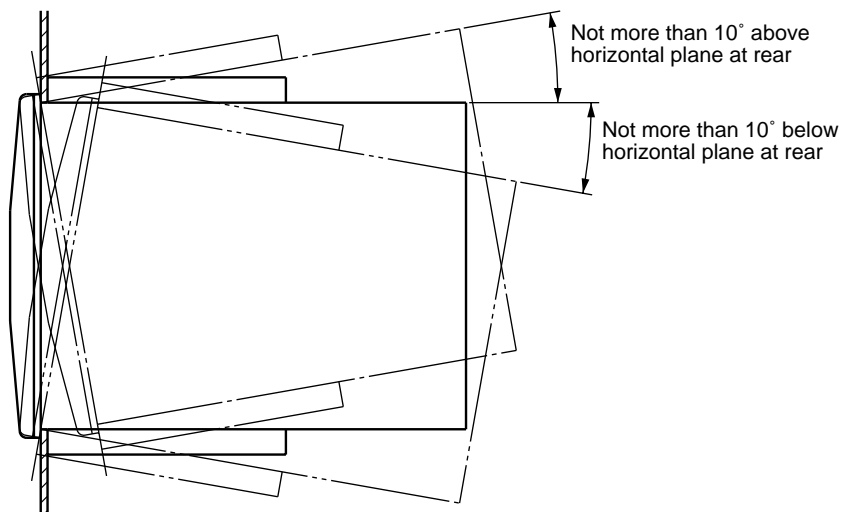

When the provided mounting brackets are firmly secured and there is no looseness, turn the screws only one full turn. Over-tightening the screws of the brackets can deform or damage the case.









- The rear of the instrument must not be more than 10° above or below the horizontal plane.



Chapter 4. WIRING

4-1 Precautions on Wiring

 WARNING	
	Connect the FG terminal to ground with a ground resistance of maximum 100Ω before connecting other equipment and external control circuits. Failure to do so may cause electric shock or fire.
	Be sure to turn off the power supply when you connect the controller. Failure to do so may lead to electric shock or fire.
	Do not touch a live part such as a power terminal. This may result in electric shock.

 CAUTION	
	Connect the controller as specified using designated cables and connection procedures. Failure to heed this caution may lead to electric shock, fire or malfunction.
	Make sure that wire scraps, chips or water do not enter inside the case of the controller. Failure to heed this caution may lead to fire or malfunction.
	Current applied to current input terminals (55), (56) and (58), (59) must meet the specified range. Failure to heed this caution may lead to fire or equipment breakdown.
	All terminal screws shall be tightened to specified torque. Improperly tightened screws may lead to electric shock or fire.
	Do not use unused terminals on the instrument as relay terminals for other equipment. Failure to heed this caution may lead to electric shock, fire or equipment breakdown.
	Attaching the terminal covers after completing the controller connections is highly recommended. Failure to heed this caution may lead to fire or malfunction. (Terminal covers are supplied with the controller.)
	Use induced lightning surge preventive device Non if there is a risk of power surges caused by lightning. Failure to do so may cause fire or malfunction.

! HANDLING PRECAUTIONS

- Before connecting the lines, verify the model number and terminal numbers on the label affixed to the side panel of the DCP551. After completing, always double check to ensure all wiring has been performed correctly before turning on the power.
- The I/O signal lines and the communications lines shall maintain at least 50 cm between them and the power supply line and power supply cables. Do not route these cables through the same conduit or duct.
- Make sure that no crimp-style solderless wire connectors are touching an adjacent terminal or connector.
- When connecting a thermocouple input of the DCP551 to another instrument, make sure the instrument's input impedance totals at least $1\text{M}\Omega$. If less than $1\text{M}\Omega$, the DCP551 may not be able to detect sensor disconnection.
- Cautions when using data input devices in combination
Input of the DCP551 input or output (connected in parallel for input) to an A/D converter, analog scanner, etc., may cause dispersion of the read data. To prevent such occurrence, take one of the following corrective measures.
 - (1) Use a low-speed integral A/D converter.
 - (2) Insert an isolator with no switching power supply between the DCP551 and the A/D converter.
 - (3) Perform averaging with a personal computer when the data is read.
 - (4) If the device permits, insert an input filter.
- Devices and systems to be connected to this unit must have the basic insulation sufficient to withstand the maximum operating voltage levels of the power supply and input/output parts.

4-2 Recommended Cables

To perform thermocouple input, connect a thermocouple element to the terminals. When the wiring distance is long or when connecting the thermocouple without the element to the terminals, connect via shielded compensating lead wires.

- For I/O other than thermocouple, use JCS4364 instrument cable or equivalent (is commonly called twisted shielded cable for instrument use).

The following cable are recommended:

Fujikura Ltd.	2-wire	IPEV-S-0.9mm ² × 1P
	3-wire	ITEV-S-0.9mm ² × 1T
Hitachi Cable Ltd.	2-wire	KPEV-S-0.9mm ² × 1P
	3-wire	KTEV-S-0.9mm ² × 1T

- A shielded multicore microphone cord (MVVS) may be used, if electromagnetic induction is comparatively low.

4-3 Making Terminal Connections

To connect a line to the terminals, use crimp-style solderless wire connectors that fit an M3.5 screw.

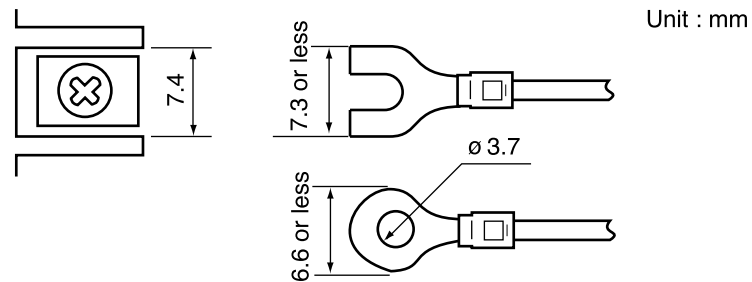

! HANDLING PRECAUTIONS

- If the DCP551 is mounted in a location subject to noticeable vibration or impact, be sure to use round crimp-style solderless wire connectors to prevent lines from becoming disconnected from the terminals.
- Be careful not to allow any of the crimp-style solderless wire connectors to touch adjacent terminals or connectors.
- The terminal screws shall be tightened to 0.78 to 0.98 N·m torque.

4-4 Terminal Array

Wires are connected to the terminal base according to the layout shown below.

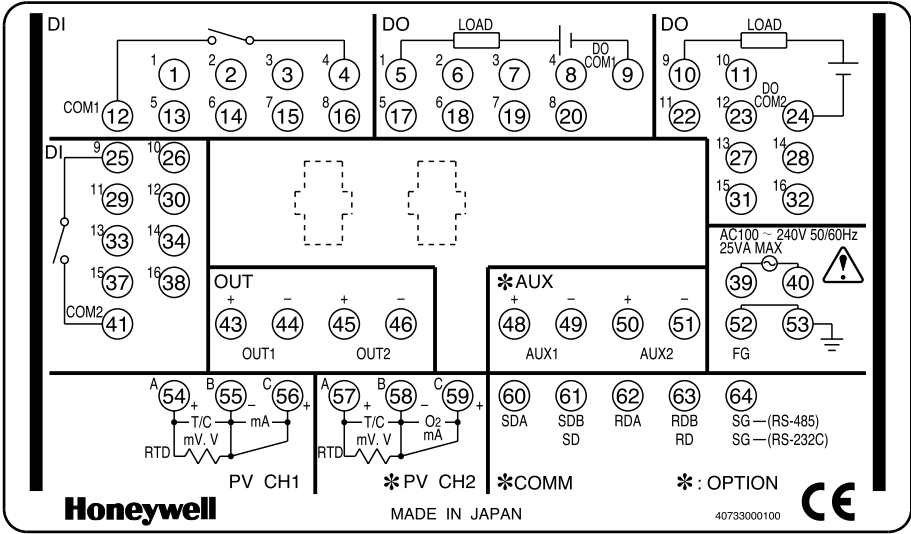

4-5 Power Supply and Grounding

■ Power supply

To supply power to the DCP551, use an instrument-dedicated single-phase power supply subject to minimal electrical interference.

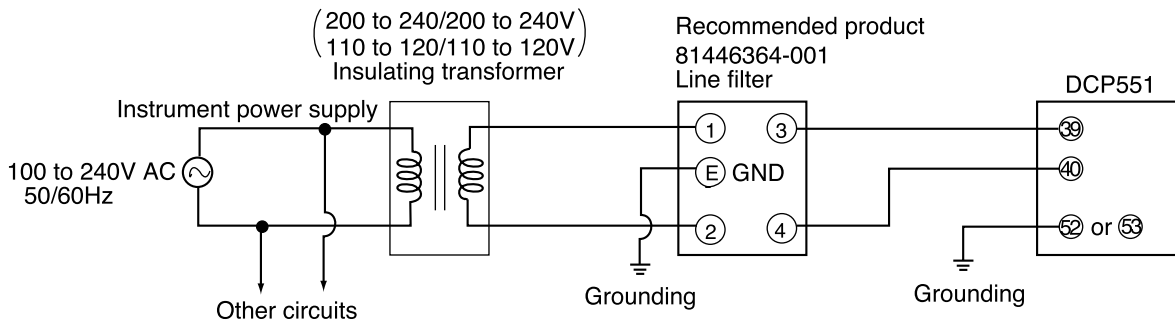

! HANDLING PRECAUTIONS

- If electrical interference proves excessive, we recommend adding an insulating transformer and/or using a line filter.
model No.: **81446364-001**
- After carrying out interference reducing measures, do not bundle the primary and secondary power supply coils together or insert them in the same conduit or duct.

■ Grounding

If grounding the shield wire or other lines proves difficult, ground them separately to a grounding terminal block.

Type : Less than 100Ω

Conductor : Annealed copper wire, min. 2mm² (AWG14)

Max. Length : 20m

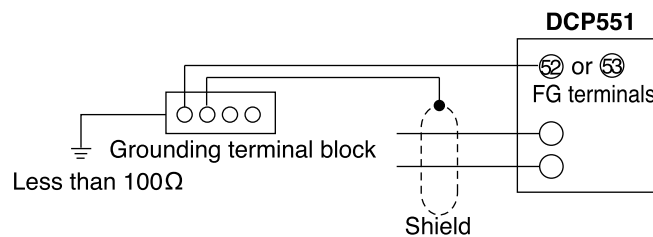

! HANDLING PRECAUTIONS

To ground the DCP551, connect the FG terminal (terminal (52) or (53) to a single ground point without jumpering.

4-6 PV Input (Analog Input) Connection

⚠ CAUTION



Current applied to current input terminals (55), (56) and (58), (59) must meet the specified range.
Failure to heed this caution may lead to fire or equipment breakdown.

■ PV input CH1 connection

PV input CH1 is a multi-input type input for sensors. Connect as shown below, according to the type of sensor being used.

• Thermocouple input

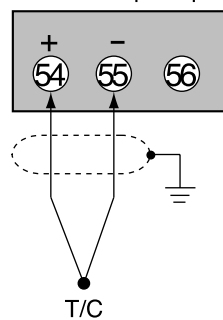

• Resistance temperature detector input

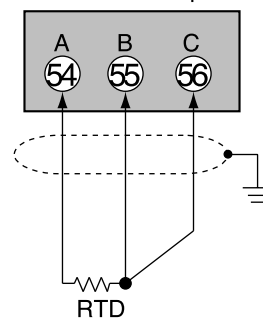

• DC voltage input

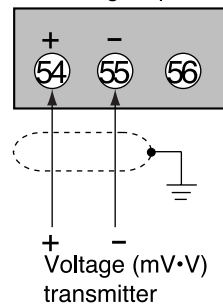

• DC current input

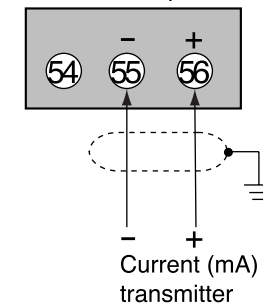

■ PV input CH2 connection

PV input CH2 is a multi-input type input for sensors. Connect as shown below, according to the type of sensor being used.

• Thermocouple input

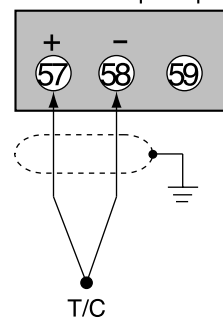

• Resistance temperature detector input

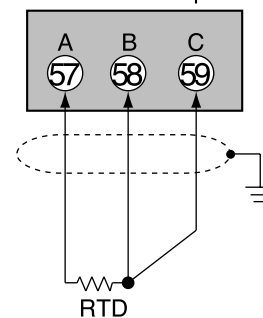

• DC voltage input

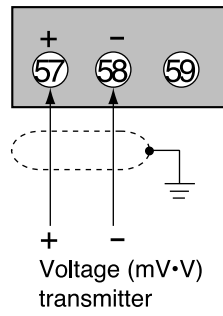

• DC current input

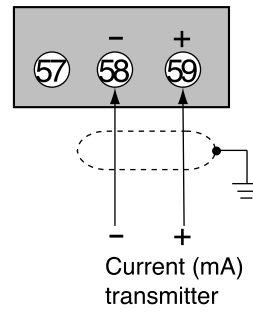

! HANDLING PRECAUTIONS

- Be careful to connect the input polarities correctly.
- Use shielded cable to connect the input.

4-7 Control Output Connection

⚠ WARNING



Be sure to turn off the power supply when you are installing or removing the controller. Failure to heed this warning may lead to electric shock.

■ Current output

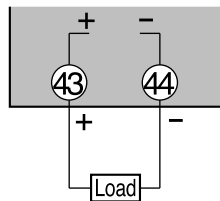

4 to 20mA DC
Load resistance less than 600Ω

■ Voltage output

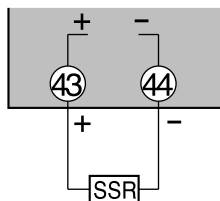

2 to 22mA DC
With current value adjustment function
(Setup data C95)

ⓘ HANDLING PRECAUTIONS

The voltage output is a constant current circuit inside. The SSR used is set to an optimum voltage to meet the requirements of the load. Enter the value in the setup data. A normal SSR voltage has been set at the factory before shipment.

■ Open collector output

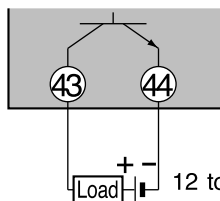

Max. load current : 100mA
Leakage current when off : less than 0.1mA

12 to 24V DC

ⓘ HANDLING PRECAUTIONS

- Do not short-circuit the positive (+) terminal of the external power supply to terminal (43) on the DCP551. Doing so causes the open collector outputs to malfunction. (There is no short circuit preventing circuit inside.)
- When connecting a semiconductor load such as a programmable controller (sequencer), select a module in which the current directions match. Use one made inoperative by the leakage current produced when the digital outputs are shut off.

4-8 Auxiliary Output (Output CH1, CH2) Connection

WARNING



Be sure to turn off the power supply when you connect the controller. Failure to do so may lead to electric shock or fire.

■ Auxiliary output CH1 connection

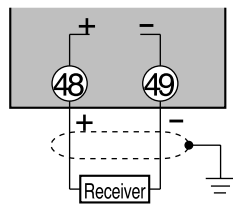

4 to 20mA DC
Load resistance less than 600Ω

■ Auxiliary output CH2 connection

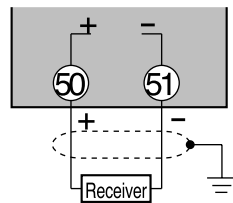

4 to 20mA DC
Load resistance less than 600Ω

4-9 Event Output (Open Collector Output) Connection

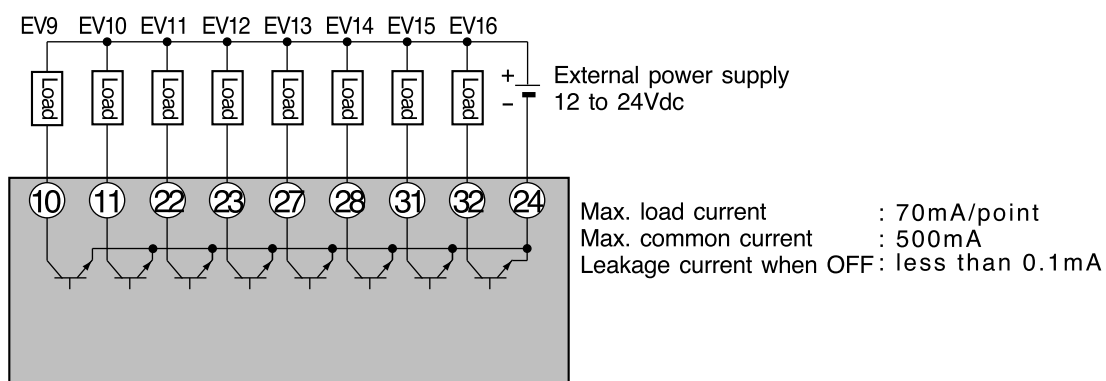
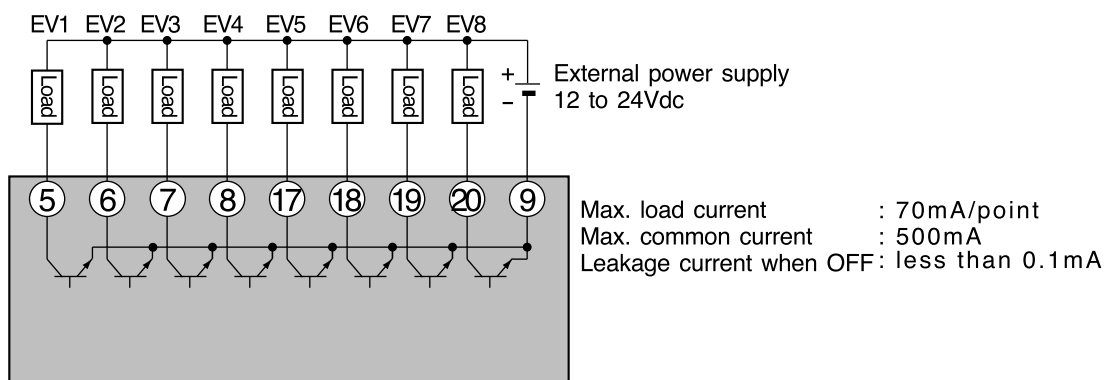

! HANDLING PRECAUTIONS

- Do not short-circuit the positive (+) terminal of the external power supply to terminals (5) to (8), (17) to (20), (10), (11), (22), (23), (27), (28), (31), and (32) on the DCP551. Doing so causes the open collector outputs to malfunction. (There is no short circuit preventing circuit inside.)
- When connecting a semiconductor load such as a programmable controller (sequencer), select a module in which the current directions match. Use one made inoperative by the leakage current produced when the digital outputs are shut off.

4-10 External Switch Input Connection

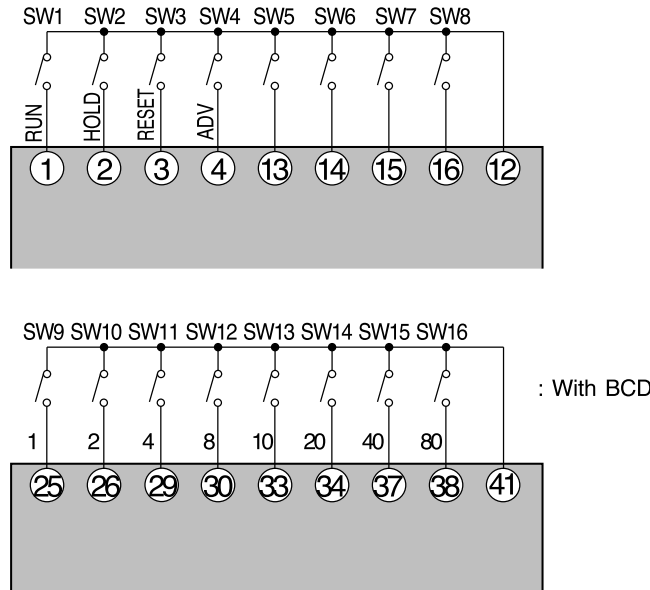

● Internal circuit diagram of the DCP551 connecting external switch input

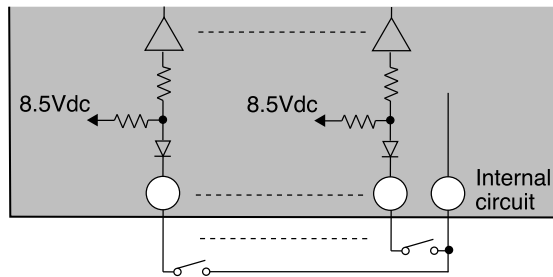

! HANDLING PRECAUTIONS

- The inputs of the DCP551 unit are provided with a built-in power supply (open voltage type, 8.5V DC). Always use no-voltage contacts externally.
- For the no-voltage contacts, use gold contacts or other relays that switch on small currents. Other types of relay contacts may not switch. Use contacts that have ample margin over the minimum switching capacity with respect to the current and open voltage ratings of contacts provided on the DCP551.
- If using semiconductors (open collectors, etc.) as no-voltage contacts, use one that maintains a potential of no more than 2V across the contacts when actuated, and a leakage current of no more than 0.1mA when shut off.
- Common terminals (12) and (41) of the external switch input are connected internally.

4-11 Communication Connection

■ RS-485 connection

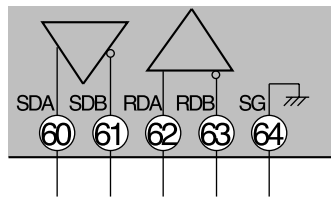

! HANDLING PRECAUTIONS

- The slave station can be connected in a multi-drop configuration.
- Always set a unique address to each slave station.
- Attach terminating resistances (a total of four when connecting a 5-wire system) to the ends of the communications lines. Use 1/2W or greater terminating resistances of $150\Omega \pm 5\%$.
- If connecting three lines, short-circuit terminals (60), (62) and (61), (63).
- Do not short-circuit the RDA to RDB and SDA to SDB terminals. Doing so may cause the DCP551 to malfunction.

● 5-wire system RS-485 connection diagram

Attach 1/2W or greater terminating resistances of $150\Omega \pm 5\%$ at each end of the communications lines. Ground the shield FGs at one end in one location, not at both ends.

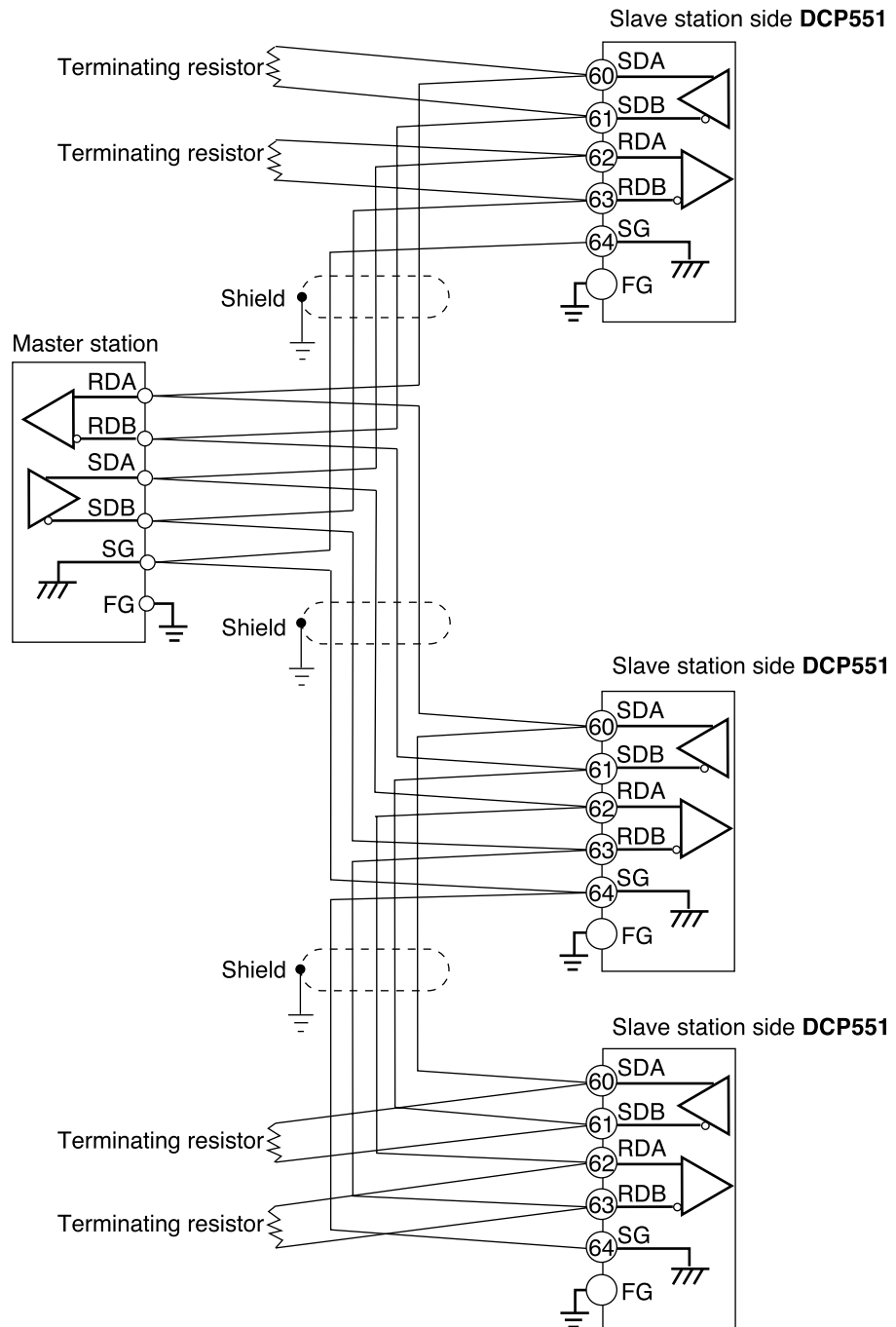

! HANDLING PRECAUTIONS

- Be sure to connect SG terminals each other. Failure to do so might cause unstable communications.

● 3-wire system RS-485 connection diagram

Attach 1/2W or greater terminating resistances of $150\Omega \pm 5\%$ at each end of the communications lines. Ground the shield FGs at one end in one location, not at both ends. When only three RS-485 terminals are provided, the areas designated with an asterisk (*) are connected internally.

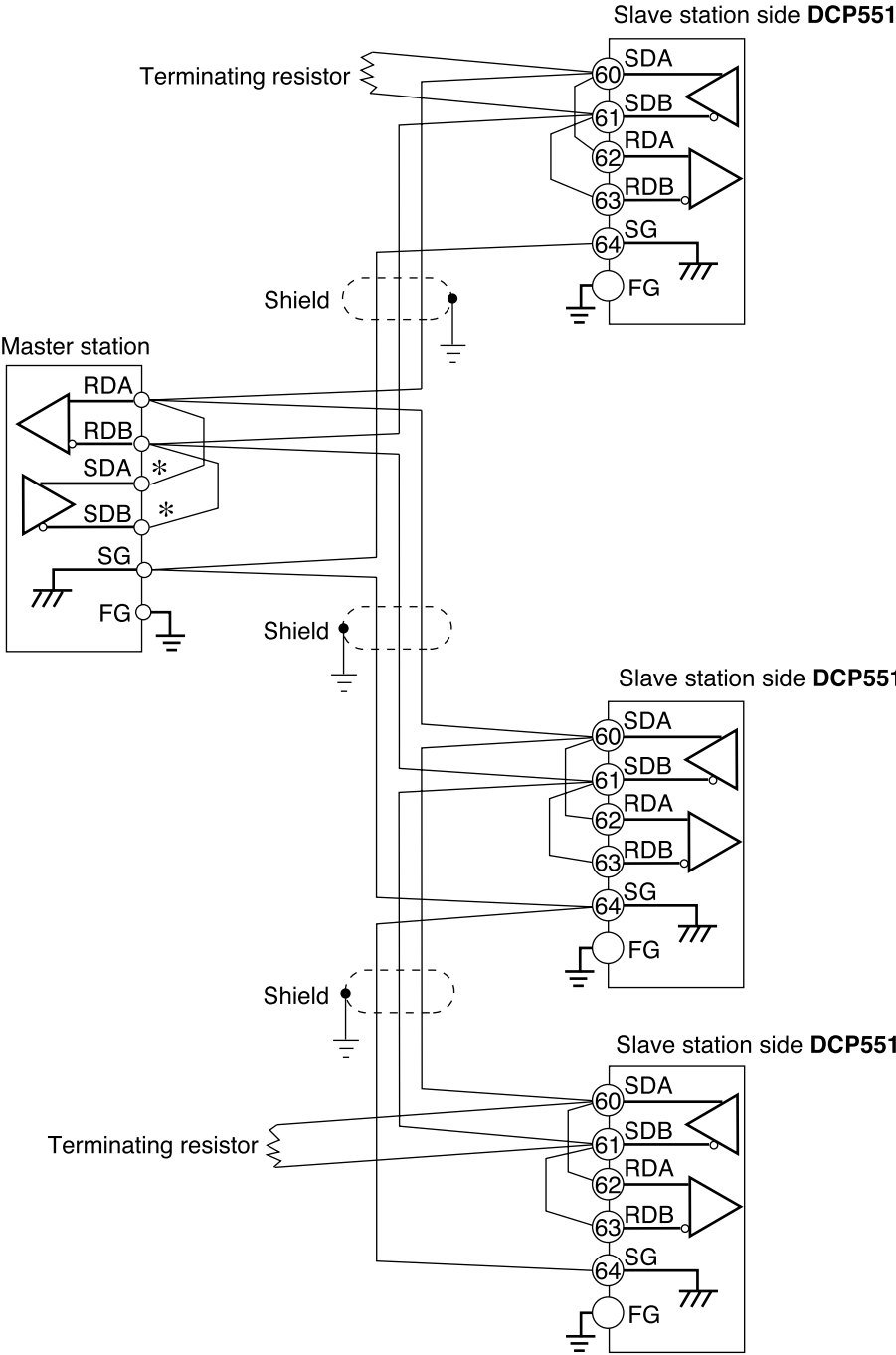

! HANDLING PRECAUTIONS

- Be sure to connect SG terminals each other. Failure to do so might cause unstable communications.

■ RS-232C connection

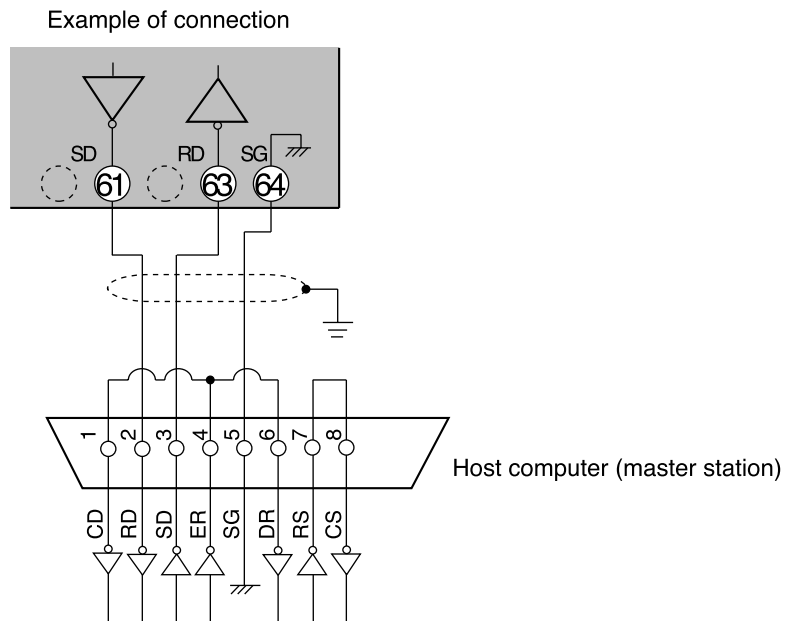

! HANDLING PRECAUTIONS

- Connect the slave station to the master station in a single-drop (point-to-point) configuration.
- There are three (SD, RD and SG) communications terminals on the RS-232C interface on the master station which may not output data if not short-circuited as shown above.

NOTE RS-232C connector signals (9 pins)
Example : IBM and compatibles

Pin No.	Name	Signal direction	
		Host	Instrument
1	DCD		←
2	RxD		←
3	TxD	→	
4	DTR	→	
5	GND		
6	DSR		←
7	RTS	→	
8	CTS		←

■ Connection to ST221

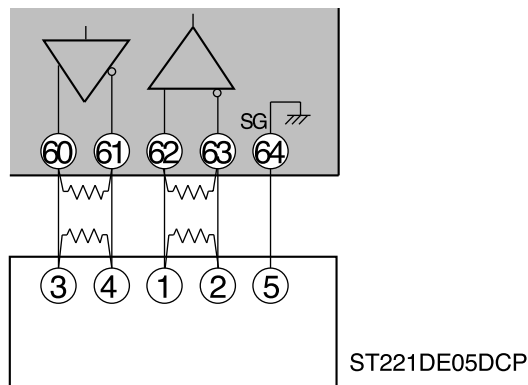

! HANDLING PRECAUTIONS

- Attach 1/2W or greater terminating resistances of $150\Omega \pm 5\%$ at each end of the communications lines.
- The DCP551 operates as a master station when connected to an ST221 during communications.

4-12 Isolation Between Input and Output

Isolation between inputs and outputs are shown below. In this figure, the solid lines enclose mutually-isolated sections. Those sections bounded by dashed lines are not isolated.

PV input CH1	Digital circuit	Control output
PV input CH2		Auxiliary output CH1
Loader communication		Auxiliary output CH2
External switch input		
Communication		Event output
Memory card input		

! HANDLING PRECAUTIONS

The loader jack is not isolated from internal digital circuits.
When not in use, always replace the cap.

Chapter 5. FUNCTIONS

5-1 Data

■ Data types

The data types are listed below.

For further information on data types, see “**Chapter 7. PARAMETER SETUP**” and “**Chapter 8. PROGRAM SETUP**”.

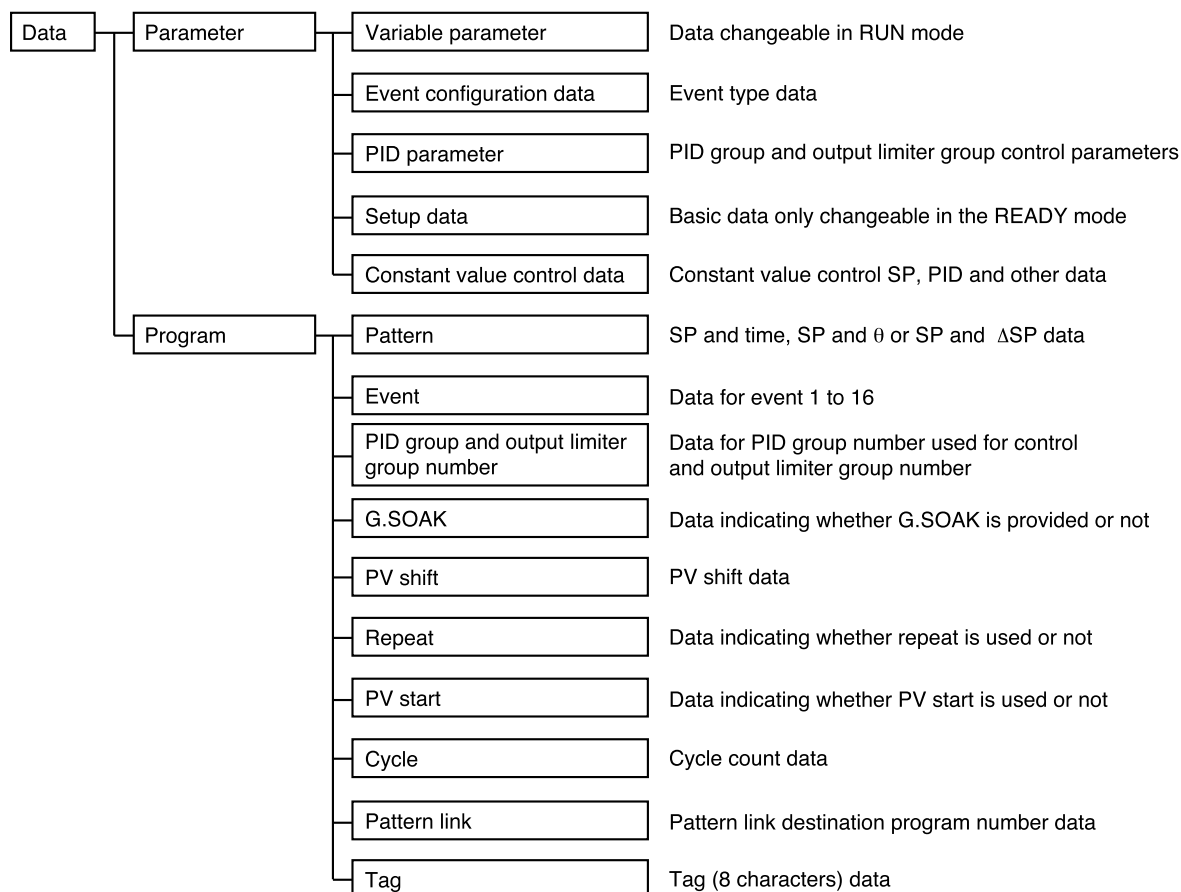

5-2 Program Pattern

■ Pattern

Three systems for selecting programs are provided: RAMP-X, RAMP-T and RAMP-E. The first segment of each program is always RAMP-X, but the other segments can be any system and all three types can be used in one program.

● RAMP-X system

This system, sets a segment of a pattern using SP and time, is called RAMP-X.

SP setting : within the upper and lower SP limiter range

Time setting : 0 hours 00 minutes to 500 hours 00 minutes

0 minutes 00 seconds to 500 minutes 00 seconds or

0.0 seconds to 3000.0 seconds

(Time units are selected using the **C62** setup data setting.)

SP is a point on the elapsed time axis in the current segment, which is a straight line connecting the start point, the SP set value in the previous segment, and the end point, the SP set value in the current segment. Segments are classified as follows.

- Rising RAMP (or rising slope)
Previous segment SP setting < current segment SP setting
- Falling RAMP (or descending slope)
Previous segment SP setting > current segment SP setting
- SOAK (soaking)
Previous segment SP setting = current segment SP setting

The start and end points of the first segment are also the SOAK segment of the SP set value for the first segment.

SP calculation (other than first segment)

$$\begin{aligned} \text{SP} = & (\text{current segment SP set value} - \text{previous segment SP set value}) \\ & \times (\text{current segment elapsed time} \div \text{current segment time setting}) \\ & + \text{previous segment SP setting.} \end{aligned}$$

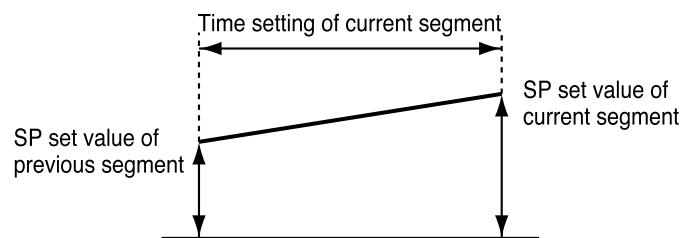

●RAMP-T system (θ setting)

In the RAMP-T system, a segment is set using SP and ramp θ (theta).

SP setting: within the upper and lower SP limiter range

θ setting : 1 to 10000 (SPU/hour, SPU/min, SPU/sec)

(Time units are selected using the **C62** setup data setting.)

SP is a point on the elapsed time axis in the current segment which is an extended straight line, the ramp set value of the current segment when the SP set value in the previous segment is the start point.

The end point is the point where this line reaches the SP setpoint of the current segment.

Note that the RAMP-T system cannot be used in the first segment.

SP calculation: $SP = \theta \text{ set value} \times \text{segment elapsed time} + \text{previous segment SP}$.

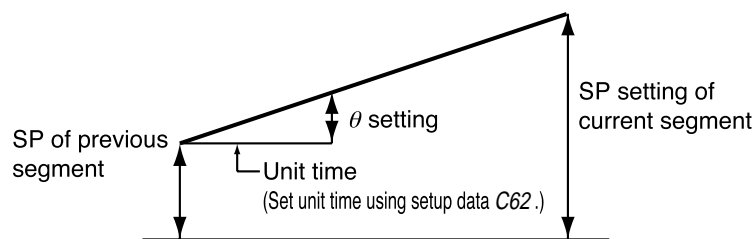

●RAMP-E system (SP setting)

In the RAMP-E system, segments are set using SP and Δ SP (digital SP) for each external switch input pulse.

SP setting: within the upper and lower SP limiter range

Δ SP setting: 1 to 10000 SPU

The start point is the SP set value in the previous segment.

SP is a value resulting from adding a multiple of the external switch input count to the SP set value when the SP in the previous segment is the start point.

The segment ends when this SP reaches the SP setting in the current segment and the current segment SP is more than the previous segment SP or when current segment SP is less than the previous segment SP.

SP calculation: when current segment SP is more than the previous segment SP, $SP = \Delta \text{ SP set value} \times \text{external switch input count} + \text{the previous segment SP}$.

When current segment SP is less than the previous segment SP, $SP = -(\Delta \text{ SP set value} \times \text{external switch input count}) + \text{the previous segment SP}$.

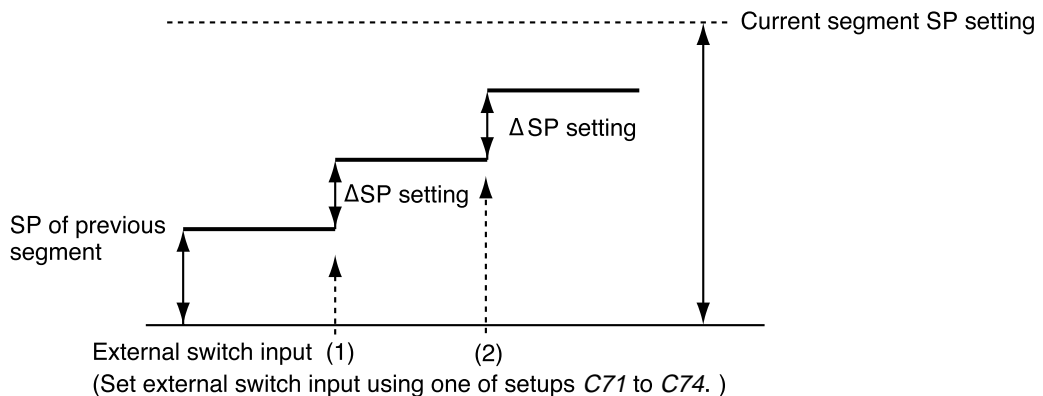



NOTE

- Select the program pattern setting system using setup data setting **C61**.
 - 0: combined use of RAMP-X and RAMP-T
 - 1: combined use of RAMP-X and RAMP-E
- Select time setting units using setup data setting **C62**.
 - 0: hours and minutes
 - 1: minutes and seconds
 - 2: 0.1 seconds
- Select θ setting units using setup data setting **C62**.
 - 0: SPU/hour
 - 1: SPU/min
 - 2: SPU/sec
- Select SP setting and SP setting decimal position using setup data setting **C65**.
 - 0: XXXXX
 - 1: XXXX.X
 - 2: XXX.XX
 - 3: XX.XXX
 - 4: X.XXXX
- External switch for pulse input requires 1: RAMP-E using a setup data setting between **C71** to **C74**.
- The pulse input interval time can be checked by setting event type 93 in the event. Event type 93 is RAMP-E time monitored during a period of 0.0 to 3000.0 seconds. Even when a setting is exceeded and there is no pulse input, the event remains on.

■ Events

The event configuration data setting allows event types to be set for event outputs 1 to 16. Events are of the following four types: time event, PV event, code event and mode event. Settings are divided into two types of events: segment events and instrument event.

- Segment events are used to set the event operating point in a program setting and makes it possible to set different set values in different segments. But in the constant value control mode segment events are off.
- Instrument events are used to set events that do not require an event operating point or set the event operating point in the event configuration setting. It performs operations that are shared by all program operations and constant value control.

● Time events

The On Time or both the On and Off Time can be set by event number and segment. Output on/off duration are as shown below.

NOTE

- The On Time is indicated by the length of the line from the start of the segment until the upturned arrow.
- The Off Time is indicated by the length of the line from the start of the segment until the downturned arrow.
- When the On Time is less than the off time, the output is on from the on time until the off time.
(See segments 1, 6 and 7 in the figure.)

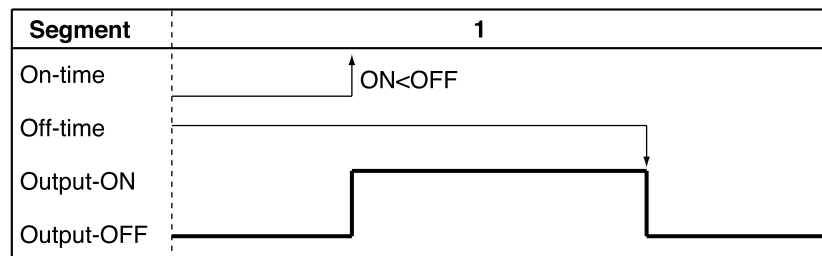

- When only an on setting is made, the output stays on until the end of the segment.
(See segments 2 and 5 in the figure.)

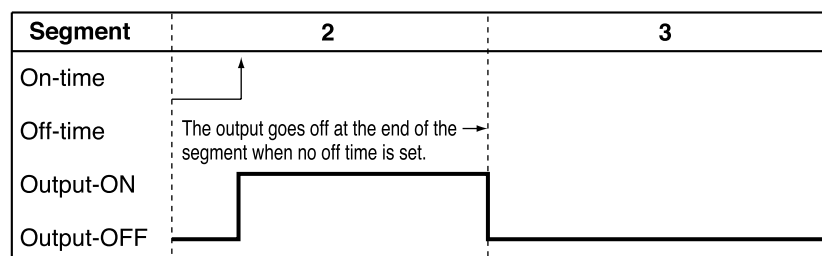

- The output is off when no On or Off Time has been set.
- An off time cannot be set without setting an on time.
(See segment 3B in the figure.)

- An On Time Off Time setting cannot be made. (See segment 3C in the figure.)

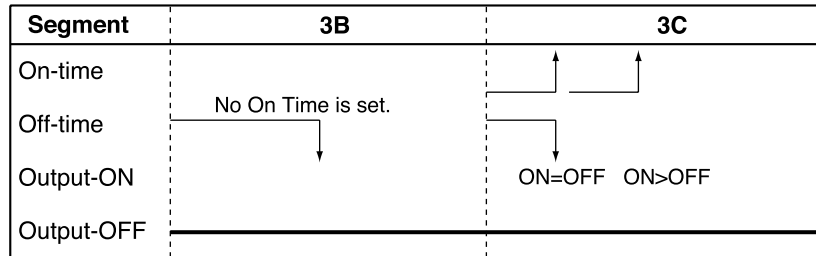

- An On Time or Off Time is valid only within a segment and cannot straddle segments. In the next segment, the On time and Off time set for that segment are valid. (See segments 4 and 5 in the figure.)

Thus an On Time and Off Time setting made at the end of a RAMP-X segment are ignored. (Compare segment 9 with the G.SOAK wait in segment 10 in the figure.)

Note, however, that an On Time or Off Time setting at the end of a RAMP-T segment is either valid or invalid depending on the computational error.

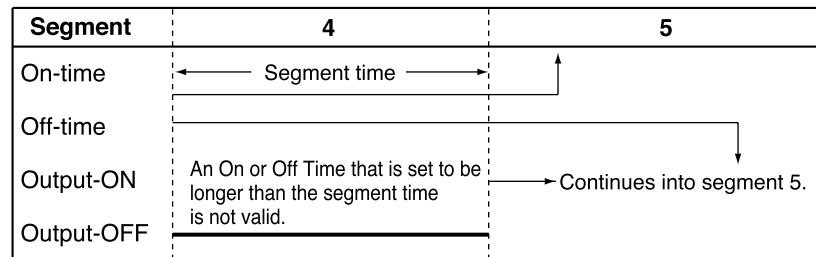

- When the On Time is set to 0 (no Off Time being set or set to more than 0), the output goes on when the On Time becomes 0. If the output was on at the end of the previous segment, it stays on and does not go off momentarily between the two segments. (See segments 5 and 6 in the figure.)

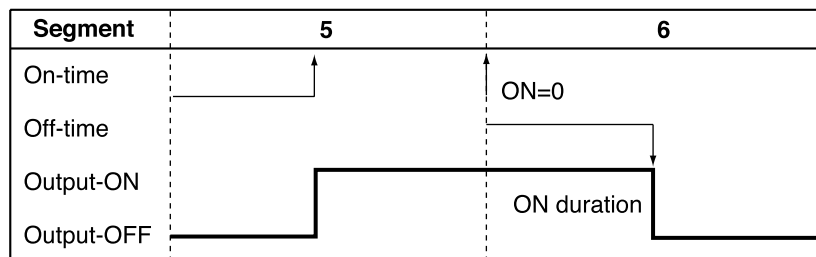

- The G.SOAK Time is not included in the On and Off Time. (See segment 7.) Nor is the Wait Time included for a G.SOAK that occupies an entire segment.

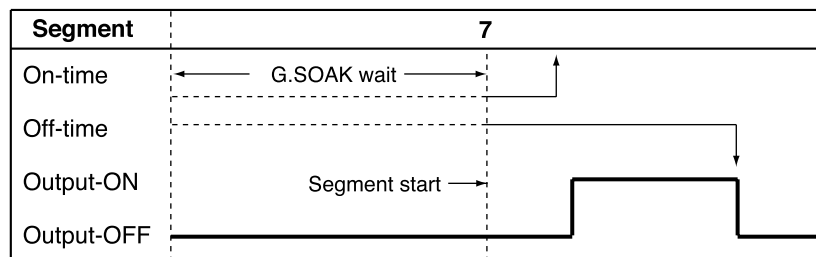

- When there is a G.SOAK wait at the start of a segment and the ON Time is set to 0, the output goes on at start of the G.SOAK wait and the On Time starts as the G.SOAK wait ends.

The output time = G.SOAK time + (Off Time – On Time) (see segment 8.)

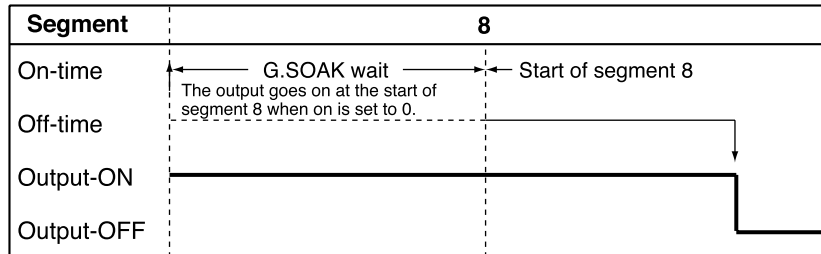

- An On Time and Off Time occurring at the end of a RAMP-X segment are valid when there is a G.SOAK wait at the end of a segment or as the end state of the final segment. (See segment 10 in the figure.)

Note, however, that an On Time or Off Time setting at the end of a RAMP-T segment is either valid or invalid depending on the computational error.

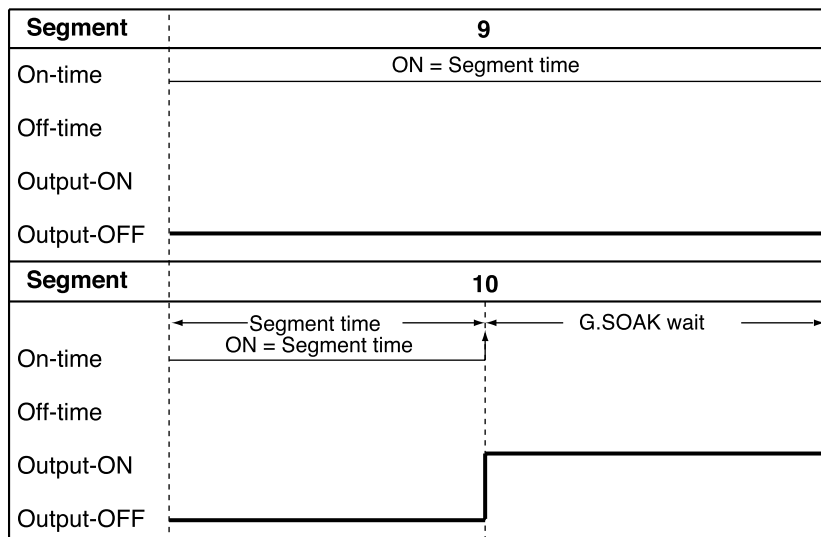

- When there is a G.SOAK at the end of the previous segment, the On Time in the next segment is ignored if it is set to 0. (See segments 11 and 12 in the figure.) Thus the ON = 0 of segment 12 is not output at the end of the set time for segment 11, but when the G.SOAK wait ends.
- This function can be combined with an event ON delay set using PARA. Delay works when an event goes from off to on. A delay is not triggered when an On Time continues across two segments as shown in segments 5 and 6 in the figure.

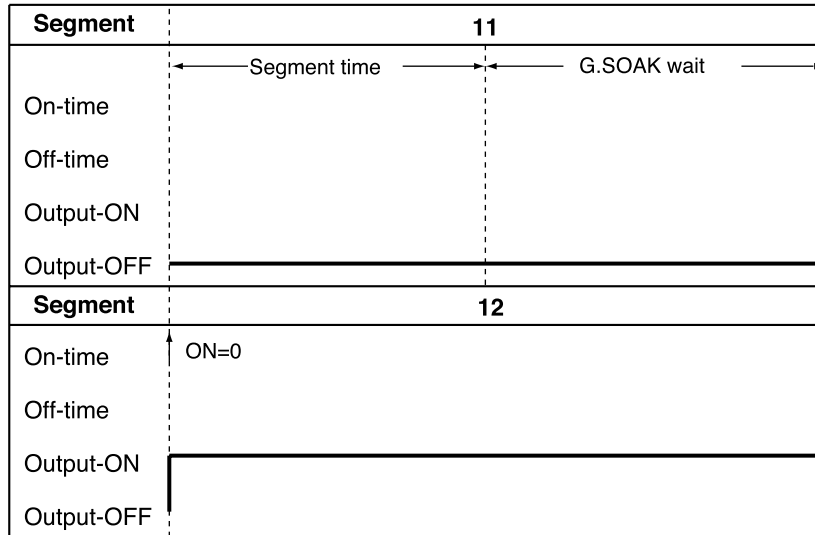

● PV event

• **Basic specifications**

The difference between PV, deviation, absolute value deviation, SP, MV and PV1-PV2 for each event type is shown on the following pages. The thick lines show ON and OFF conditions. The upper line indicates ON and the lower line indicates OFF conditions. EV indicates the event set value and H indicates the hysteresis value. Outputs in READY mode are OFF. But normal PV1 upper and lower limit operation and normal PV2 upper and lower limit operation events run also in the READY mode.

• **Event standby**

Standby events operate as described below.

- If the event is in the gray area shown in the figure during a change from READY to RUN mode or when the power is restored after an outage, the event operates without a standby. The upturned arrows in the figures indicate ON while the downturned arrows indicate OFF.
- If the event is outside the gray area shown in the figure during a change from READY to RUN mode or when the power is restored after an outage, it remains off until it enters the gray area . After entering the gray area , the upturned arrows in the figures indicate ON while the downturned arrows indicate OFF. A standby event is off in the READY mode.

• **Event on delay**

The number of the event to be delayed and the delay time can be set regardless of event type. The delay turns on the output for the duration of the delay when the event meets the conditions for going from OFF to ON. When this function is combined with the event standby function, the event on delay operates when the standby state is cleared.

• **Segment event progress**

- The output stays OFF until the program reaches a segment with an event.
- The event goes ON or OFF according to the set value of the event.
- Previous settings are valid until segments with other event settings are reached.
- Previous settings are valid when the program has reached segment number 1 using the cycle function or pattern link function. The output is turned off if there is no event in segment number 1.

• **Other functions**

The MV forward/backward event does not operate when the **C21** setup data setting is set to 0 during SP output (programmer function).

Normal PV2 upper and lower limit operation events and PV1-PV2 differential of upper limit and lower limit events during automatic PV channel switching do not operate on models with only one PV input channel.

Normal PV1 upper and lower limit operation event and normal PV2 upper and lower limit operation events operate in the READY mode.

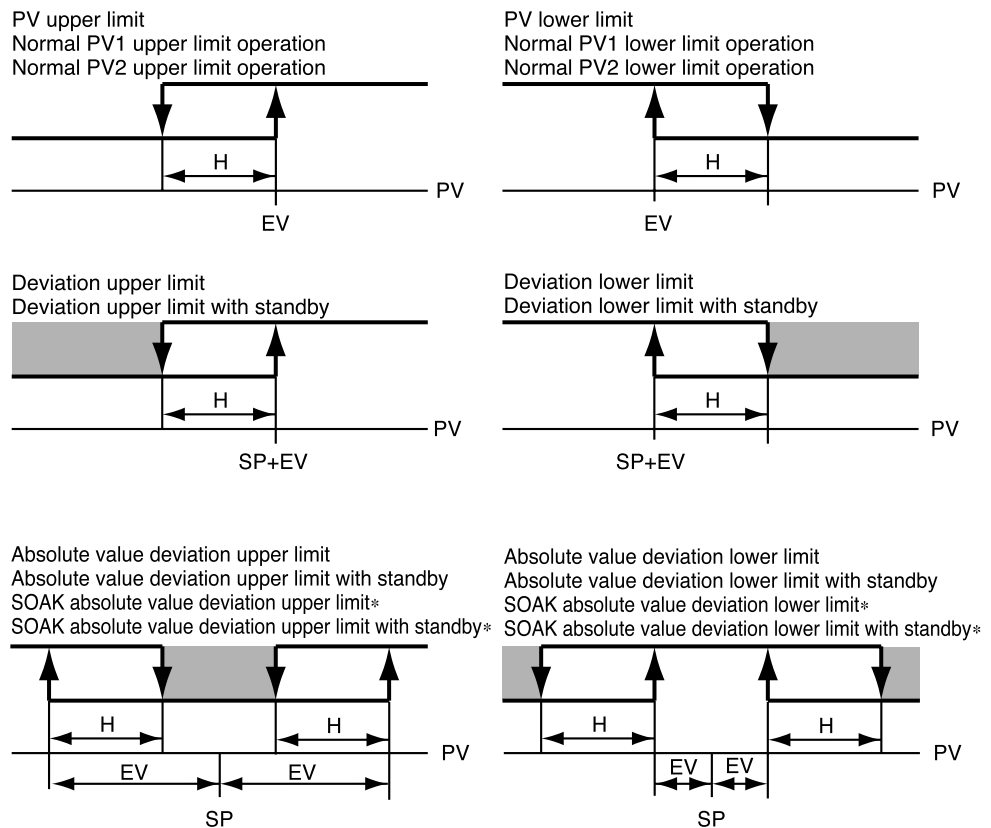

Items marked * operate only in SOAK segments. Items marked * operate only in SOAK segments.

SP upper limit

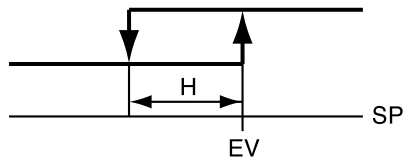

SP lower limit

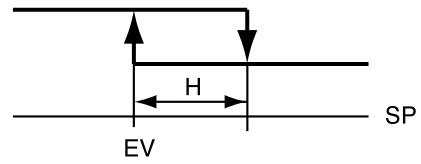

MV upper limit

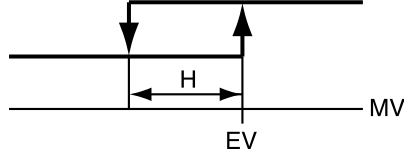

MV lower limit

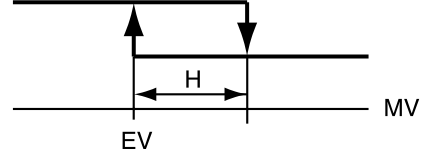

PV1-PV2 differential upper limit

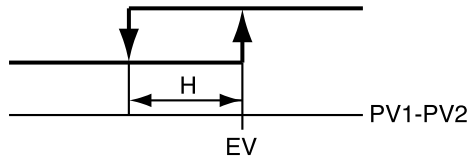

PV1-PV2 differential lower limit

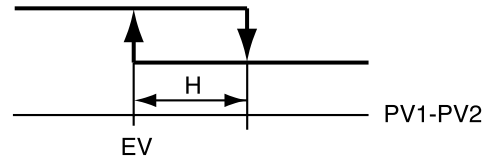

PV1-PV2 differential upper limit during automatic PV channel selection

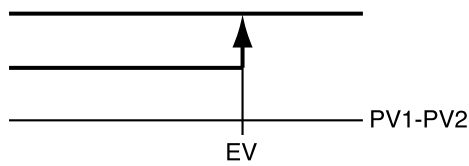

PV1-PV2 differential lower limit during automatic PV channel selection

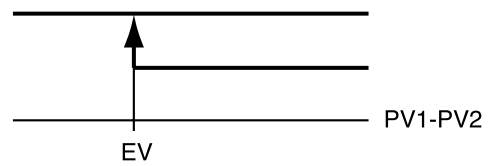

Note: When the output goes on, it stays on until READY mode.

Note: When the output goes on, it stays on until READY mode.

● PV deviation rate event

PV deviation is measured in each sampling cycle set using event configuration while on/off states are determined by comparing event setting deviation rate PVs. PV deviation between sampling cycles is ignored. Event on/off switching is performed according to the sampling cycle. This function can be combined with event on delay.

Set event value is more than 0 (using upper limit event)

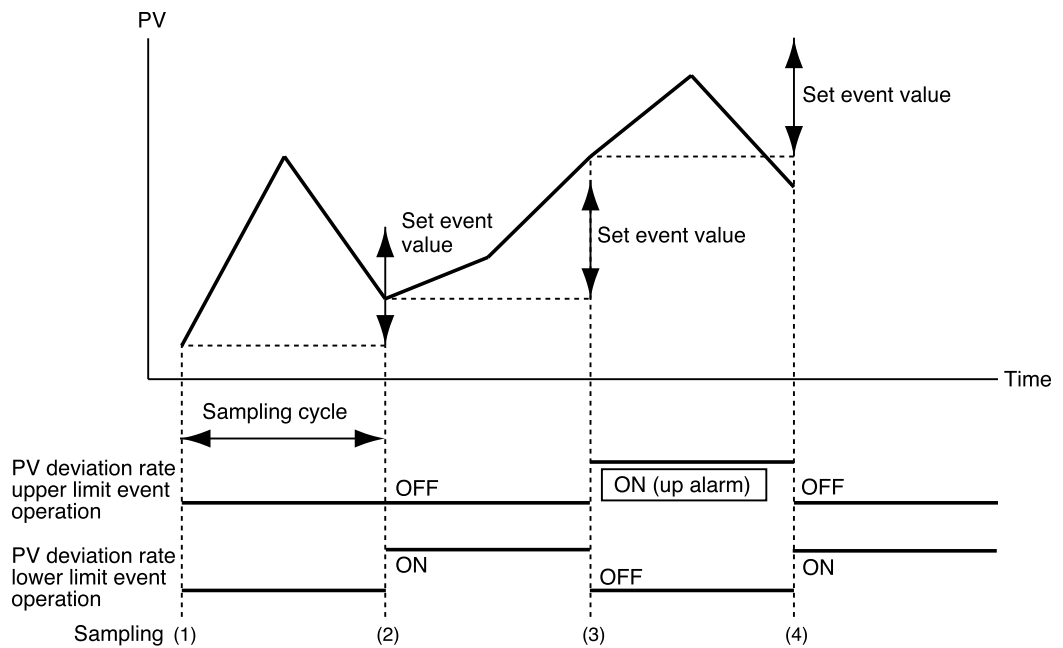

Set event value is less than 0 (using lower limit event)

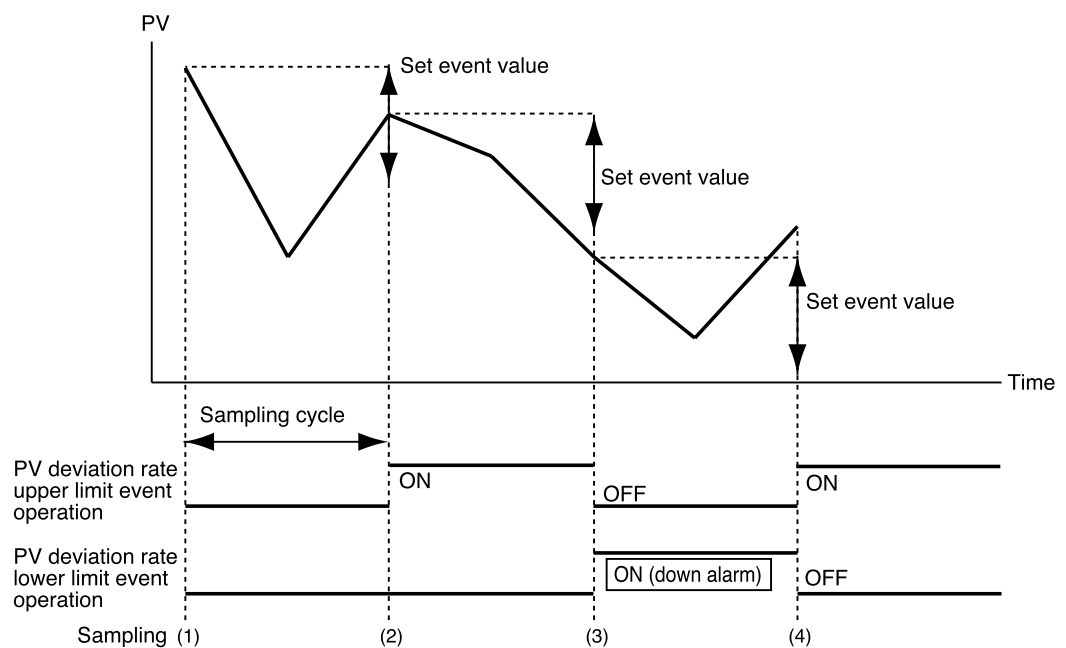

● **Code event**

Several events are used as one group and the number of output points are output as one parallel code number. Assigning code numbers to event outputs has the same effect as increasing the number of physical output points.

• **Code event**

Set event type to code event and set the number of output points (1 to 8) in auxiliary setting 1. An output code value (0 to 255) can be set for each segment. A binary coded low-order bit for the set number of output points is output.

The previous setting is valid until the program reaches a segment with a new setting. Note, however, that unless a setting is made in the first segment, the program will assume that a set value of 0 is set in the first segment.

Example: Setting a code event involving 3 output points in event 3

The table below shows the output state when a value of 3 is set in segment 2, a value of 6 is set in segment 4 and a value of 0 is set in segment 5.

Segment	1	2	3	4	5
Set value	Not set	3	Not set	6	0
Code value 1 in event 3	OFF	ON	ON	OFF	OFF
Code value 2 in event 4	OFF	ON	ON	ON	OFF
Code value 4 in event 5	OFF	OFF	OFF	ON	OFF
Output code	0 (OFF,OFF,OFF) (0, 0, 0)	3 (OFF,ON,ON) (0, 1, 1)	3 (OFF,ON,ON) (0, 1, 1)	6 (ON,ON,OFF) (1, 1, 0)	0 (OFF,OFF,OFF) (0, 0, 0)

- **Timed code event**

This function is a combination of a code event and a time event. The set code value is output at the set time. The number of settings that can be made in the first segment is the same as the number of output points. For example, for a 3-point output up to three settings can be made in the first segment.

Like a time event, a time within the time of the segment is valid and those that exceed the value are ignored. When the program reaches the start time of the first segment or a new segment, the set code value is 0 (all points off) until the set time of the time event.

Example: Setting a timed code with 3 output points in event 3

The table below shows the output state when a value of 5 is set in segment 2 and set to start at the beginning of the segment, a value of 3 is set to occur 0:10 after the start of segment 2 and a value of 4 is set to occur 0:30 after the start of segment 4.

Segment	1	2	3	4	5		
Set value	Not set	5	3	Not set	6	0	
Set time	Not set	0.00	0.10	Not set	0.30	0.00	
Time		← 0.10 →			← 0.30 →		
Code value 1 in event 3	OFF	ON	ON	OFF	OFF	OFF	
Code value 2 in event 4	OFF	OFF	ON	OFF	OFF	ON	OFF
Code value 4 in event 5	OFF	ON	OFF	OFF	OFF	ON	OFF
Output code	0 (OFF,OFF,OFF) (0, 0, 0)	5 *1	3 *2	3 (OFF,OFF,OFF) (0, 0, 0)	0 *3	6 *4	0 (OFF,OFF,OFF) (0, 0, 0)

*1: (ON,OFF,ON)
1, 0, 1

*2: (OFF,ON,ON)
0, 1, 1

*3: (OFF,OFF,OFF)
0, 0, 0

*4: (ON,ON,OFF)
1, 1, 0

- **Program/segment number event**

A program or a binary coded segment number is set in an event type and the number of output points (1 to 7) is set in auxiliary setting 1. Or a program or a BCD code of the segment number is set in an event type and the number of output points (1 to 8) is set in auxiliary setting 1.

A selection, a program designed for a specific operation or a coded segment number is output. A low-order bit code corresponding to the set number of output points is output.

- **An event on delay can be combined with the code event**

Note, however, that when there are several channel code events, the delay has to be entered for each channel.

Decimal binary code comparison table

Decimal	Binary code output (0: Off output 1: On output)
1	0 0 0 0 0 0 1
2	0 0 0 0 0 1 0
3	0 0 0 0 0 1 1
4	0 0 0 0 1 0 0
5	0 0 0 0 1 0 1
6	0 0 0 0 1 1 0
7	0 0 0 0 1 1 1
8	0 0 0 1 0 0 0
9	0 0 0 1 0 0 1
10	0 0 0 1 0 1 0
11	0 0 0 1 0 1 1
12	0 0 0 1 1 0 0
13	0 0 0 1 1 0 1
14	0 0 0 1 1 1 0
15	0 0 0 1 1 1 1
16	0 0 1 0 0 0 0
17	0 0 1 0 0 0 1
	⋮

Decimal BCD code comparison table

Decimal	BCD code output (0: Off output 1: On output)
1	0 0 0 0 0 0 0 1
2	0 0 0 0 0 0 1 0
3	0 0 0 0 0 0 1 1
4	0 0 0 0 0 1 0 0
5	0 0 0 0 0 1 0 1
6	0 0 0 0 0 1 1 0
7	0 0 0 0 0 1 1 1
8	0 0 0 0 1 0 0 0
9	0 0 0 0 1 0 0 1
10	0 0 0 1 0 0 0 0
11	0 0 0 1 0 0 0 1
12	0 0 0 1 0 0 1 0
	⋮
20	0 0 1 0 0 0 0 0
30	0 0 1 1 0 0 0 0
40	0 1 0 0 0 0 0 0
50	0 1 0 1 0 0 0 0
	⋮

● Mode event

This event goes on or off depending on controller mode, alarm generation and other states.

It cannot be combined with the event standby function but with the on delay function. It does not set event set values (operating points) or hysteresis.

- **Basic operations**

The following types are provided.

RUN + HOLD + END + FAST

HOLD

READY + READY FAST

END

G.SOAK wait

MANUAL

During auto-turning execution

FAST + READY FAST

Console setting operation

RUN

ADV (advance)

Full alarm (logical OR)

PV range alarm

Instrument alarm

PV1 selected

PV2 selected

Battery voltage drop

The event goes on when the specified instrument state is reached and is off at other times.

- **Alarm**

Alarms are of two types: PV range alarm group (alarm code number 01 to 04) and instrument alarm group (alarm code number 91 to 99 and battery voltage drop).

When the event type is all alarm, the event goes on if one alarm occurs.

When the event type is a PV range alarm, the event goes on if one alarm in the PV range alarm group goes on.

When the event type is an instrument alarm, the event goes on if one alarm in the instrument alarm group goes on.

- **ADV**

When ADV (advance) is executed, the event goes on for 1 second. This function is valid during on delay.

■ PID group selection

- PID groups can be selected in two ways: by setting a PID segment or through automatic PID group switching.
A PID group segment and automatic PID group switching can also be combined.
When a PID group number is set to 0, the setting in the previous segment is continued.

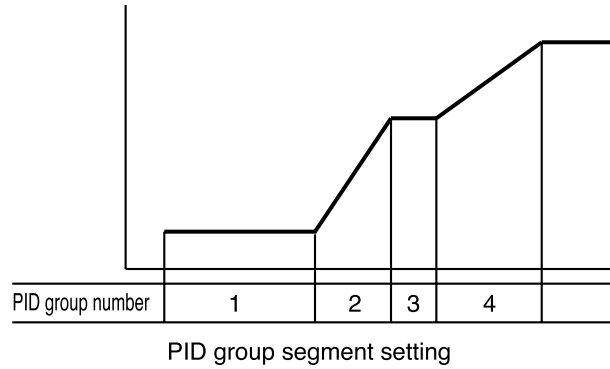

- In a PID group segment setting a PID group number is set in each segment and PID parameters are used for calculating the control output. The nine PID groups **PID1** to **PID9** can be used.
- In automatic PID group switching, the entire SP scale is divided into seven zones assigning **CP-A1** to **CP-A6** to each. The PID constants that are used according to SP values are automatically selected to calculate control output. The PID group number for each segment specifies A. Seven PID groups from **PID-A1** to **PID-A7** can be used.

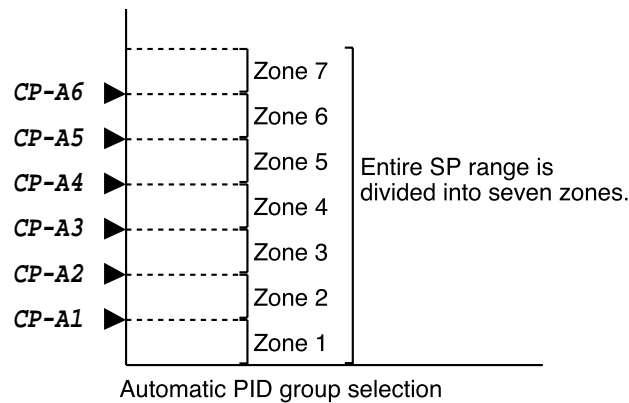

■ Selection of output limiter group

- Output limiter group number can be set for each segment to control the lower limit (OL) and upper limit (OH) of the control output. **oL** and **oH** groups 1 to 9 can be used.
- The output limiter can only be specified by segment; automatic selection cannot be made.
- When the output limiter is set to 0, the setting in the previous segment is continued.

■ G.SOAK (Guarantee soak)

G.SOAK on/off state, type and G.SOAK width is set by the segment. G.SOAK are of three types: segment start point, segment end point and the entire segment.

G.SOAK time is set using the variable parameter **PA46** setting. Any offset between SP and PV triggers a G.SOAK wait which narrows the distance between SP and PV to guarantee the segment execution time. G.SOAK operates not only on SOAK but also on RAMP segments.

Note, however, that in FAST mode a G.SOAK setting does not trigger a G.SOAK wait. G.SOAK can be cleared with an external switch input. The following types of clearing conditions can be selected using setup data setting **C71** to **C74**.

- (1) G.SOAK is cleared when an external switch contact is set to on or when PV meets the G.SOAK clearing conditions.
- (2) G.SOAK is cleared when an external switch contact is set to on and PV meets the G.SOAK clearing conditions.

• G.SOAK at start of segment

PV and SP are compared at the beginning of the segment. The segment starts when the absolute value of the difference continues beyond the G.SOAK time and becomes narrower than G.SOAK width.

A G.SOAK wait state continues until these conditions are met which is announced by the flashing of the linear LED on the left of the profile display.

The operating condition is the same as HOLD at the beginning of a segment (time = 0).

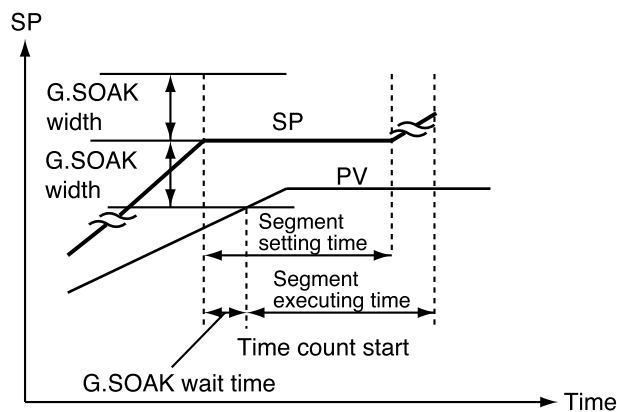

• **G.SOAK at end of segment**

PV and SP are compared at the end of the segment. The operation in that segment ends when the absolute value continues beyond the G.SOAK time and becomes narrower than G.SOAK width.

A G.SOAK wait state continues until these conditions are met which is announced by the flashing of the linear LED at the center of the profile display.

The operating condition is the same as HOLD at the end of a segment (time = set segment time).

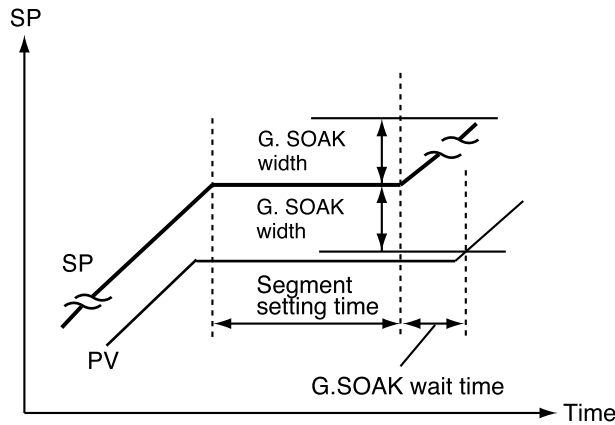

• **G.SOAK for entire segment**

PV and SP are compared at across the entire segment. The operation in that segment continues when the absolute value continues beyond the G.SOAK time and becomes narrower than G.SOAK width.

A G.SOAK wait state continues until these conditions are met which is announced by the flashing of the linear LED at the left and the center of the profile display.

The operating condition is the same as HOLD at the continued time.

■ **PV shift**

A PV correction value can be set for each segment. PV is PV input value plus PV bias and PV shift. Note, however, that in the READY mode and the constant value control mode, PV bias but not PV shift is added to the PV input value.

The setting in the previous segment continues when PV shift is set to “-----”(nothing).

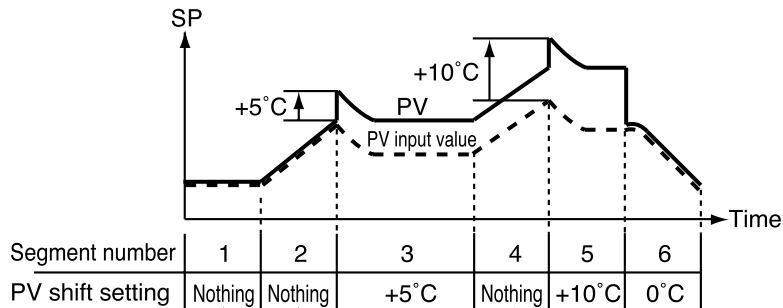

↑ +5°C setting is continued.
 A “No PV shift setting” that continues from the first segment has the same effect as a PV shift 0°C setting.

Repeat

Repeat on/off and return destination are set by the segment with the segment number and repeat count. Operation completes at the end of a segment. If there is a repeat setting, the program returns to the start of the set destination segment and operation is resumed from there. This operation is repeated the number of times specified by the repeat count.

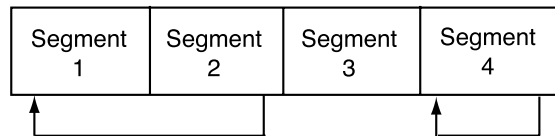

No repeat is performed when the destination segment number is larger than the current segment number. When the program returns to the first segment, PV is not started even if a PV start setting has been made.

! HANDLING PRECAUTIONS

- When repeat operations involve multiple segments and the destination segment settings overlap, nest or intersect, the repeat operation will become an abnormal eternal loop. Do not make such settings.

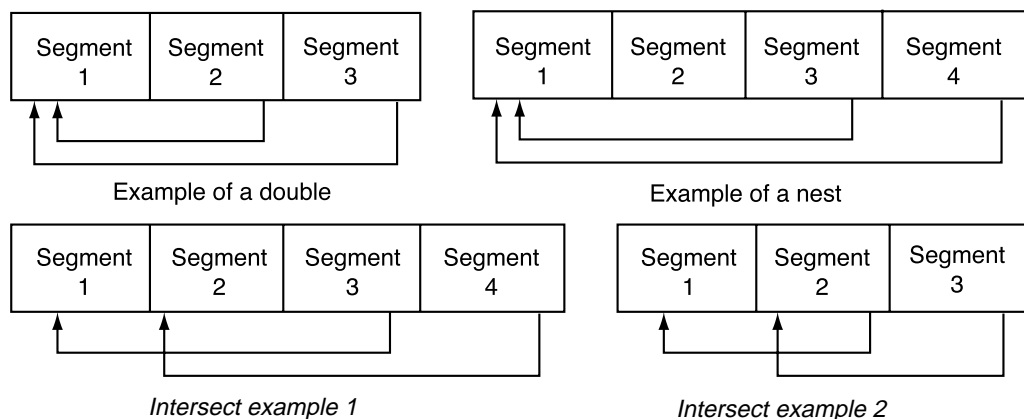

- When the current segment does not contain a set value or the value is 0, executed values for program items (for example, set PV event values or set PID group selection values) that are sequels to settings in a previous segment are the same during the first run and the repeat run.

■ PV start

When a PV start is set in the program setting, a PV start is performed in a normal RUN operation.

The program looks for the first point where PV and the program pattern SP are equal (both PV and SP include bias) and starts operation from there. PV starts are of three kinds: rising PV start that looks for a point where PV and SP are equal on a rising RAMP, falling PV start that looks for a point where PV and SP are equal on a falling RAMP and bi-directional PV start that looks for such a point both on rising and falling RAMPS.

Note, however, that if there is no point where PV and SP are equal, operation starts from the beginning of segment 1.

When a PV start has been implemented, the event operating point and the time event time are automatically corrected. This is described in the figure shown below. When PV is at (1) in the figure, a rising PV start or a bi-directional PV start starts from B and a falling PV start starts from C. When PV is at (2) in the figure, a falling PV start or a bi-directional PV start starts from D and a rising PV start starts from A. When PV is at (3) in the figure, any PV start starts from A.

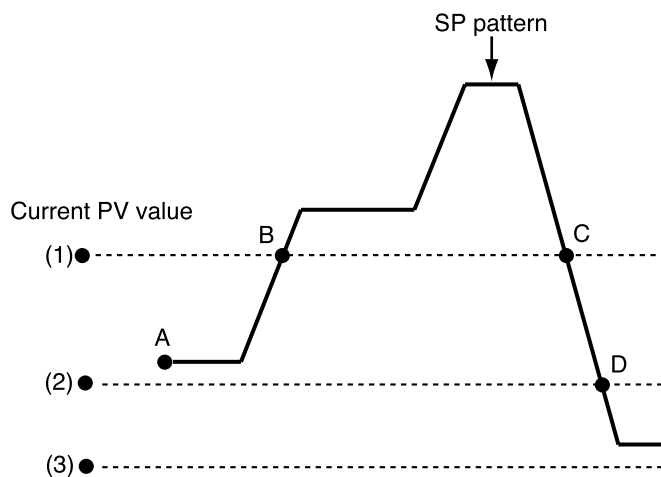

 **NOTE** PV start is valid for segments in the selected program but not for segments beyond a pattern link destination.

■ Cycle

The cycle function allows you to repeat operation from segment 1 to the last segment in a program pattern the number of times set in the cycle count. A total of 10,000 times can be set.

When a cycle number of n is set, the total operation count is $n + 1$. During cycle operation, the operation at the last point in the final segment is not performed and executed values of program items (sequels to settings in the previous segment) that continue from a previous segment are cleared before program restart.

When the SP start point and end point are not equal, SP changes in a step-like manner during cycle operation.

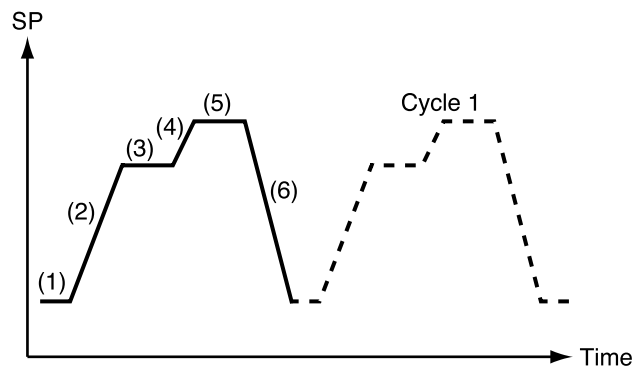

■ Pattern link

The pattern link function links patterns; the program number of the link at the destination is set in the pattern link item. An initial value of 0 indicates that linking is not performed.

When the number of the program is set in the pattern link item, it forms an eternal loop. When SP at the end of the original link and SP at the destination are not equal, SP changes in step-like manner.

When cycle operation has been set, the pattern link operates after the cycle operation has been completed.

Since operation starts from the first segment at the destination during pattern linking, executed values of program items (sequels to settings in the previous segment) that continue from a previous segment are cleared before program restart.

When a PV start has been programmed in a pattern at the destination link, the PV start function operates after the link has been made.

PID computations are not initialized but continued after a link has been established.

When the READY mode is invoked at the end of an operation or in a RESET operation, operation returns to program number 1 that is switched from READY to RUN mode (RUN to READY). If a RESET is performed when a program at the pattern link destination is reached during an ADV operation in the READY mode, operation returns to segment 1 of the link destination program number. Note, however, that program numbers selected using the external switch takes priority.

Linking program No. 1 and program No. 2

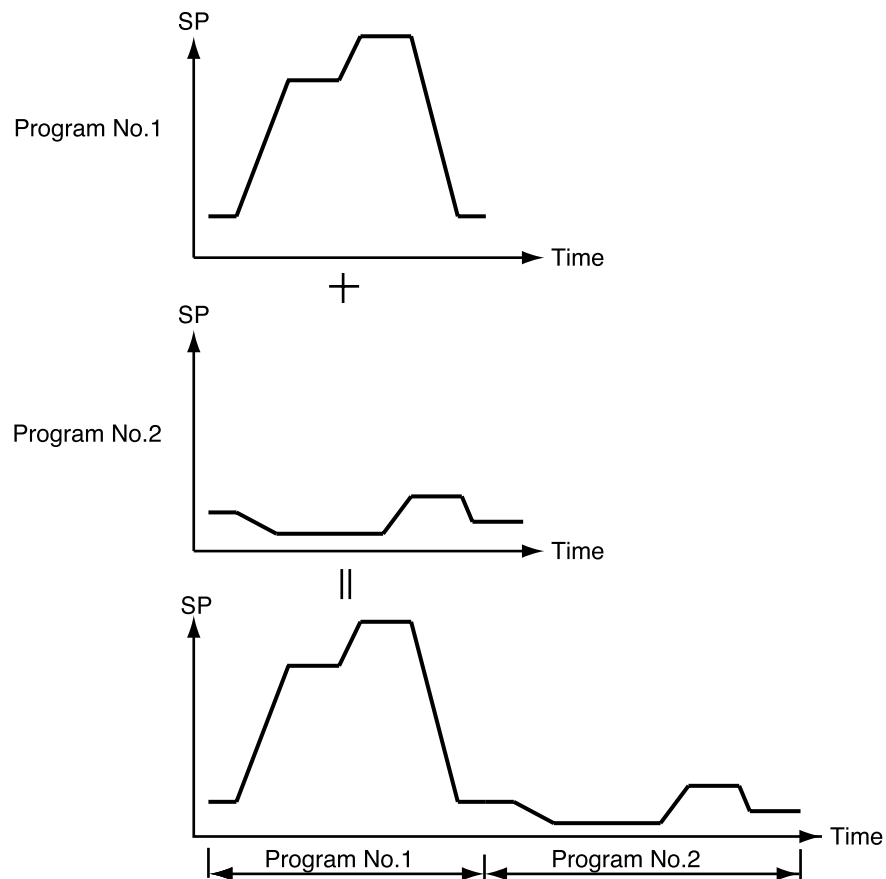

■ Tag

Tags are 8-character alphanumerics, katakana or symbols that can be entered in a program.

When segment 1 pattern item is set in a program setting, a total of eight characters consisting of PROG plus two characters in the program number and “__” two space characters.

Example: Program no. 1 : “*PROG01__*”

Program no. 19 : “*PROG19__*”

5-3 Mode

■ Mode types

Modes are listed below.

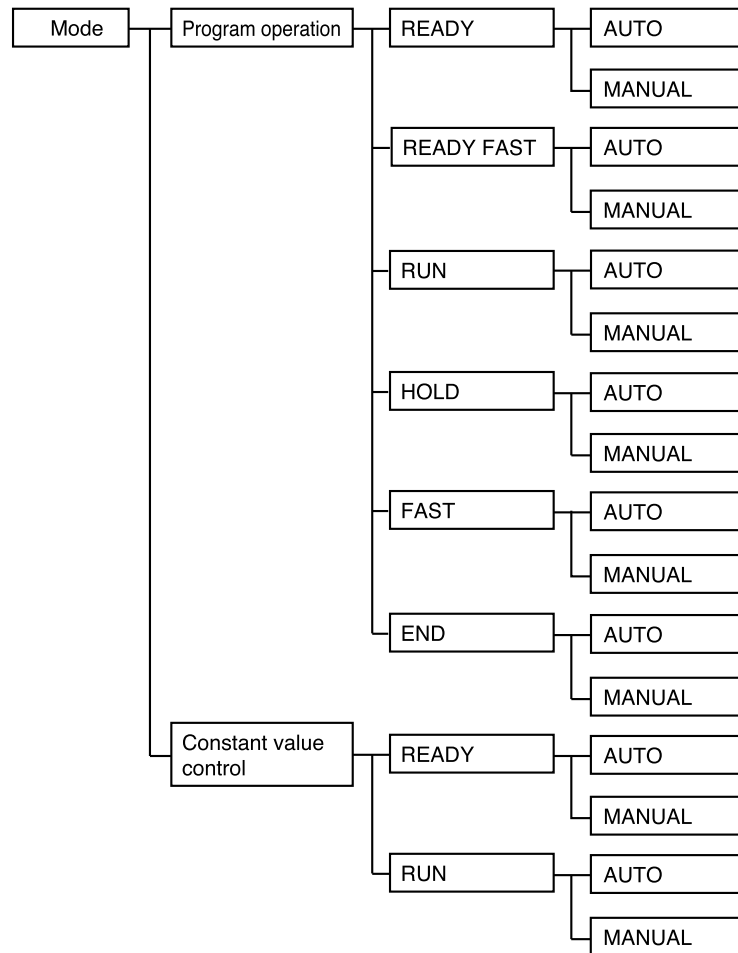

● Program operation

The program is run according to SP, time, events and other settings made in program patterns 1-99.

● Constant value control

The control is run according to SP and events made with the constant value control data.

● READY

READY indicates that the program is ready to run.

MV becomes fixed and events whose operation depends on values set in the segments are turned off. Note, however, that DCP551 state dependent events still run.

Program numbers between 1 to 99 and set segment numbers can be selected during program operation.

All setup data, some event configuration data and some constant value control data parameters can be changed in the READY mode.

Memory cards can also be used in the READY mode.

●RUN

The RUN mode indicates that the program is run sequentially.

MV output and events operate during PID control, ON-OFF control and other types of control. In the program RUN mode, program operation progresses according as time elapses. Note, however, that G.SOAK (guarantee soak) wait, like the HOLD mode, halts program operation.

●HOLD

The HOLD mode temporarily halts program operation.

Note, however, that, like the RUN mode, MV output and events operate during PID operation, ON-OFF control and other types of control. During constant value control the HOLD mode cannot be invoked.

●FAST

The FAST mode is essentially a speeded-up version of the RUN mode. The time factor is selected using variable parameter **PA39**. MV output and events operate during PID control, ON-OFF control and other types of control. G.SOAK (guarantee soak) settings are ignored.

During constant value control the FAST mode cannot be invoked.

●END

The END mode indicates the state of a program that has run its course.

When a program stops at the end, MV output and events operate during PID control, ON-OFF control and other types of control.

During constant value control the END mode cannot be invoked.

●READY FAST

The READY FAST mode is a combination of the READY and FAST modes.

MV output, SP output and events operate in the same way as in the READY mode. Program numbers and segment numbers cannot be selected. Parameters that can only be changed in the READY mode and memory card operation cannot be performed in this mode.

During constant value control the READY FAST mode cannot be invoked.

●AUTO

The AUTO mode performs automatic operation. MV outputs can be used depending on DCP551 control. (Note, however, that when programmer functions are selected, DCP551 dependent SP outputs operate.)

●MANUAL

The MANUAL mode performs manual operation.

The “↑”, “↓”, “←” and “→” console keys can be used to change communications and MV output.

(Note, however, that when setter functions are selected, communications and SP output can be changed.)

■ Mode transitions

● Program operation

Mode transitions are indicated by the solid line arrows and end operation is indicated by the dashed lines in the figure below.

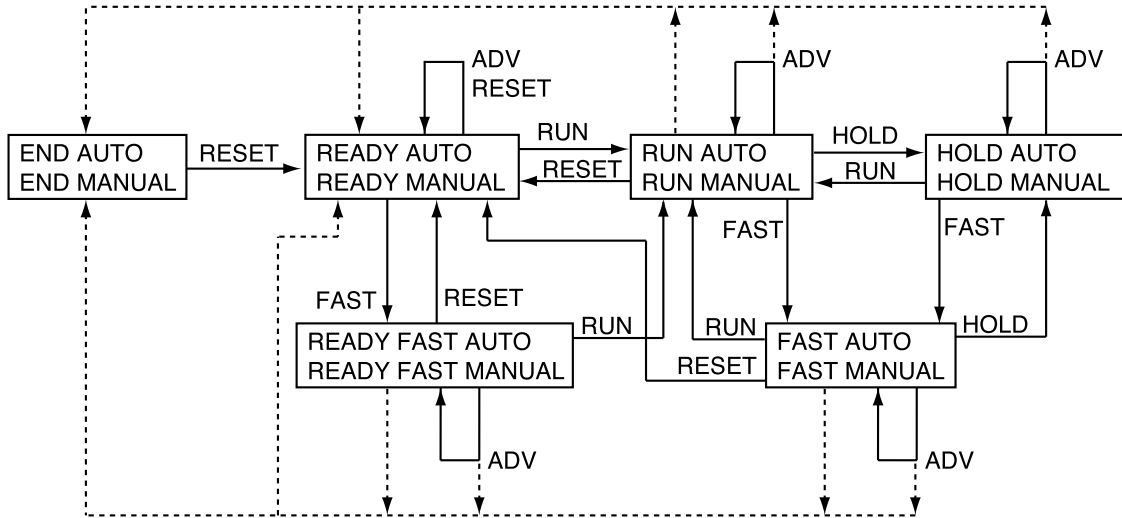

NOTE

- AUTO ↔ MANUAL mode changes can be made in the boxes of each mode.
- READY and END at the end of operation can be selected using setup data **C31**.

● Constant value control

Mode transitions are indicated by the solid line arrows.



NOTE

AUTO ↔ MANUAL mode changes can be made in the boxes of each mode.

● Switching between program operation and constant value control

Constant value control data “**ConSt**” control mode item in the READY mode is used to switch between these two modes.

- 0: Program operation
- 1: Constant value control

NOTE

Constant value control is available only when setup data setting **C21** is set to more than 0. When **C21** is set to 0, **ConSt** is also set to 0.

■ Mode transition operations

Mode transitions are performed using the following operations.

Although “Operation end” is not an operation, it is described here as a factor in mode transitions.

●RUN

Switches from the READY, HOLD, FAST and READY FAST modes to the RUN mode. To go from the READY mode or READY FAST to the RUN mode using keys, external switches or transmission, the DCP551 must be in basic display status.

●HOLD

Switches from the RUN and FAST modes to the HOLD mode. During constant value control the HOLD mode cannot be invoked.

●RESET

Switches from the RUN, HOLD, FAST, END and READY FAST modes to the READY mode.

In program operation, the reset involves returning the program to the first segment.

●ADV

Brings the program forward by one segment in the READY, RUN, HOLD, FAST and READY FAST modes. ADV (advance) operation is not available in the constant value control mode.

●FAST

The FAST mode is invoked from the RUN, HOLD, READY and READY FAST modes. During constant value control the FAST mode cannot be invoked.

●AUTO

Switches from the MANUAL mode to AUTO mode.

●MANUAL

Switches from the AUTO mode to MANUAL mode. The basic display status changes as follows during this transition.

- A controller function displays PV and output value (%).
- The programmer function displays PV and SP.

Switching from AUTO to MANUAL using external switches or transmission invokes the basic display status even when the parameter setting status or programmer setting status are in use.

●Operation end

Operation ends when all progress of program settings including cycle and pattern links reach the end in the RUN, FAST and READY FAST program operation modes or during an ADV operation. By making a setup selection, it is possible to set READY or END as the state of the controller when the program reaches its end.

Note, however, that when an operation ends in the READY FAST mode, it always ends in the READY mode. In constant value control mode, operation end is not available.

■ Mode transition restrictions

Modes can be changed using console keys, external switch inputs or through communications. The table below shows the operations that are valid for each mode.

Operation		RUN (To RUN mode)			HOLD (To RUN mode)			RESET (To READY mode)			ADV (To next segment)			FAST (To FAST or READY FAST mode)		
		Key	Switch	Commu- nication	Key	Switch	Commu- nication	Key	Switch	Commu- nication	Key	Switch	Commu- nication*	Key	Switch	Commu- nication
Program operation	READY	*	*	*	-	-	-	-	Δ	*	-	*	-	*	*	*
	RUN	-	-	*	*	○	*	*	○	*	*	○	*	*	○	*
	HOLD	*	○	*	-	-	*	*	○	*	*	○	*	*	○	*
	FAST	*	○	*	-	○	*	*	○	*	*	○	*	-	-	*
	END	-	-	-	-	-	-	*	○	*	-	-	-	-	-	-
	READY FAST	*	*	*	-	-	-	*	○	*	*	○	*	-	-	*
Constant value control	READY	*	*	*	-	-	-	-	-	*	-	-	-	-	-	-
	RUN	-	-	*	-	-	-	*	○	*	-	-	-	-	-	-

Operation		MANUAL (To MANUAL mode)			AUTO (To AUTO mode)		
		Key	Switch	Communication	Key	Switch	Communication
Program operation	AUTO	*	○	*	-	-	*
	MANUAL	-	-	*	*	○	*
Constant value control	AUTO	*	○	*	-	-	*
	MANUAL	-	-	*	*	○	*

○ : Valid operation

* : Operation from basic display status valid

 : Returns to the first segment remaining in the READY mode.

* : Operation is invalid, but the communication end code is normal if performed in the basic display status.

- : Invalid operation

* ADV operation performed via communications may not go to the next segment but to the segment set in the communications message.

5-4 Controllers and Programmers

Setup data **C21** allows the user to select the controller function or the programmer function.

● Controller

PID controller computations can be performed using PV, SP and PID set values and the result of the manipulated variable is output via an analog output.

ON-OFF control can be used instead of PID control.

In the MANUAL mode, manipulated variable levels can be controlled by keys available in the basic display status.

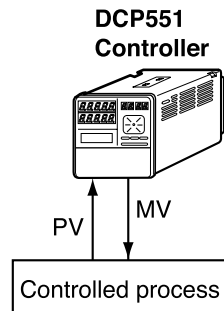

● Programmer

PID control computations are not performed and 4 to 20mA output of scaled SP signals are output.

In the MANUAL mode, SP levels can be controlled by keys available in the basic display status.

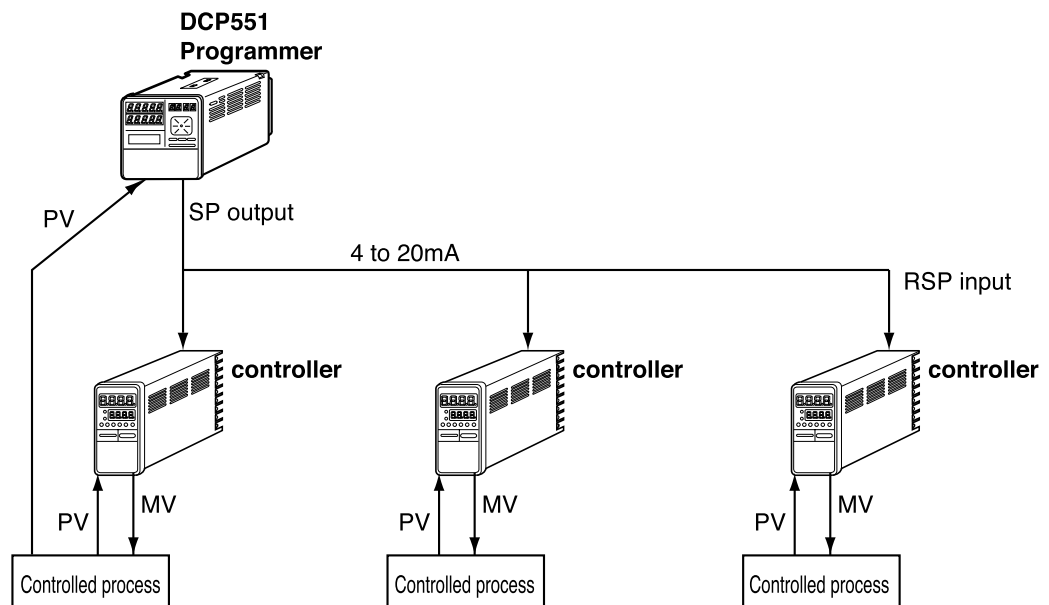

 **NOTE** The constant value control mode cannot be invoked when the programmer function is used.

5-5 Input Process Functions

This section uses diagrams to describe input processes.

■ PV input 1 channel model

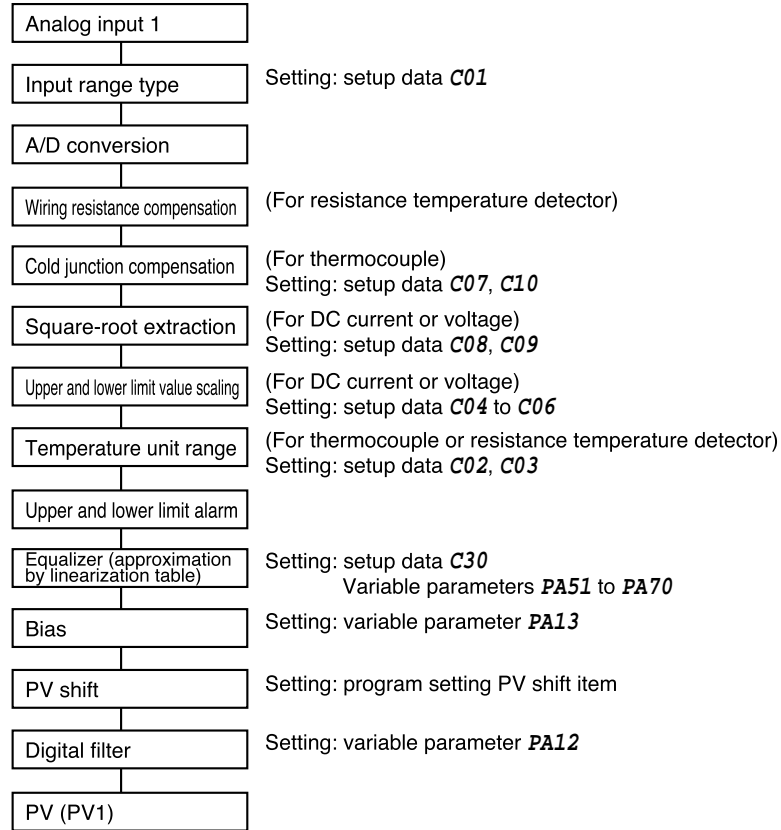

NOTE The use of equalizer (approximation by linearization table) is shown in the figure below. When a sensor with curved characteristics is used to measure PV, a linearization table is used.

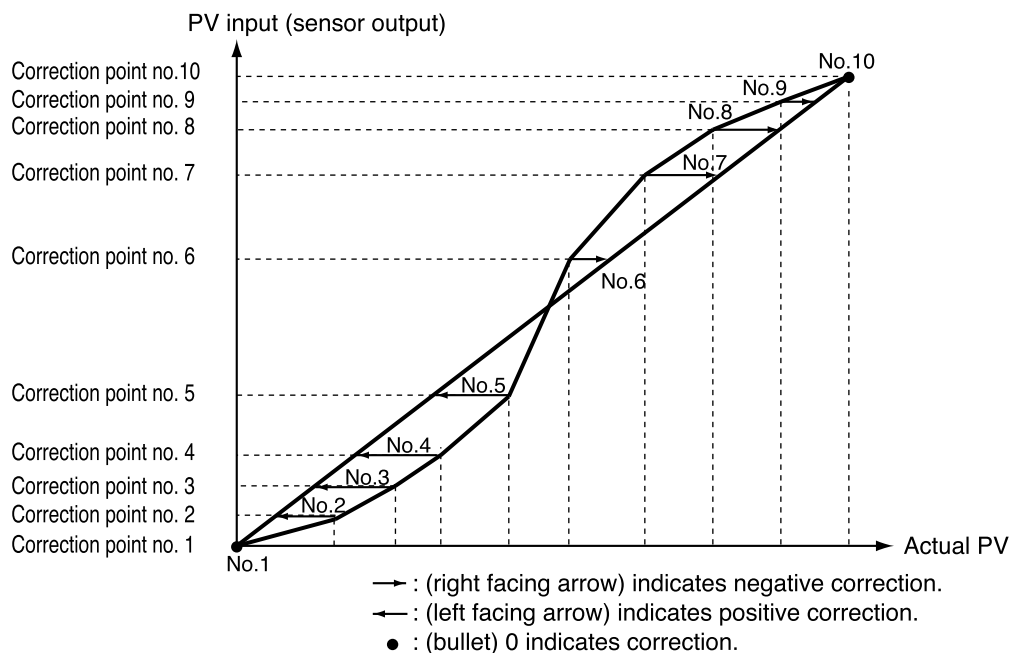

■ PV input 2 channel model

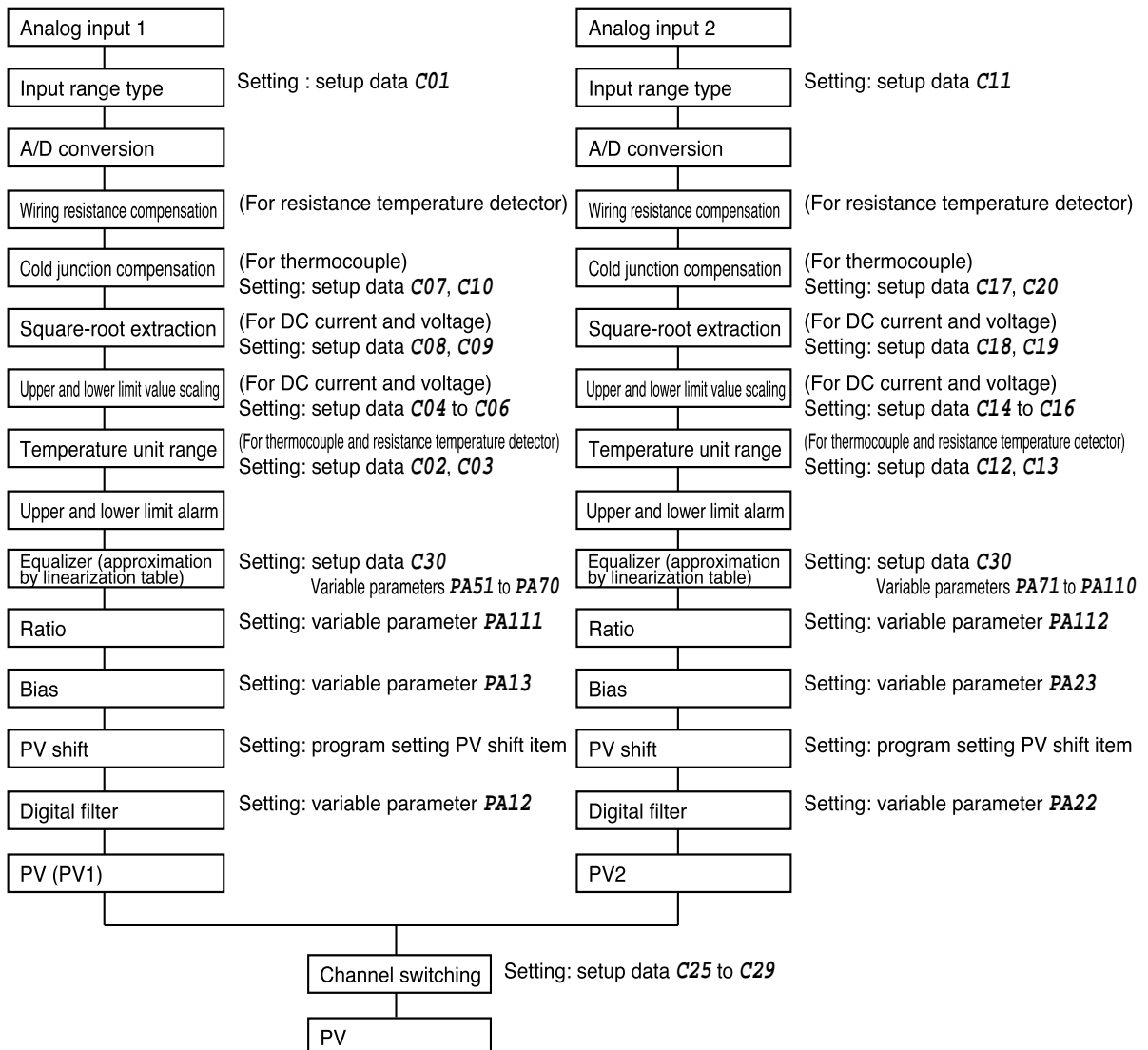

■ Channel switching (PV input 2 channel model)

● Switching types

The following switching types are provided.

- Selecting high and low-temperature sensors for PV CH1 (CH1 below) and PV CH2 (CH2 below)
 - (1) CH1 is a low-temperature sensor + CH2 is a high-temperature sensor
 - (2) CH1 is a high-temperature sensor + CH2 is a low-temperature sensor
- CH tied for control use
PV tied for operation and control
 - (1) Tied CH1 PV
 - (2) Tied CH2 PV
- Backup switching

Two temperature sensors are used. Thus if one sensor should breakdown, the program can switch to the other and continue normal operation. The main channel (CH1) is used for operation and control. In the event of an overrange (up or downscale), the subchannel (CH2) is used for operation and control to ensure normal operation. When both the main and subchannels are in overrange, the main channel is used. The manipulated variable setting during this overrange is valid. The normal channel is CH1 and the subchannel is CH2. Note, however, that when 7 is set in one of setup data **C71** to **C74**, this situation is reversed when an external switch is turned on.



NOTE

Switching type

Setup data setting **C25**

0: Low-temperature CH1, high-temperature CH2

1: Low-temperature CH2, high-temperature CH1

2: CH1 setting

3: CH2 setting

4: Backup switching

● Low-temperature, high-temperature switching systems

The following switching system is used when CH1 is a low-temperature sensor and CH2 is a high-temperature sensor or CH1 is a high-temperature sensor and CH2 is a low-temperature sensor.

- Switching using the external switches

To switch using the external switches, set 0 in setup data **C26** and 7 in one of settings **C71** to **C74**.

Switch to CH1 when the external switches are off and switch to CH2 when they are on. When the external switches are off, the CPL communications command (WS or WB) can be used to switch between CH1 and CH2.

- Automatic changeover A

Set 1 in setup data setting **C26** to allow automatic changeover to set the temperature (switch point) where channels are switched and the dead band setting that prevents switch chattering. Examples 1 to 4 below describes switch operations.

Example 1:

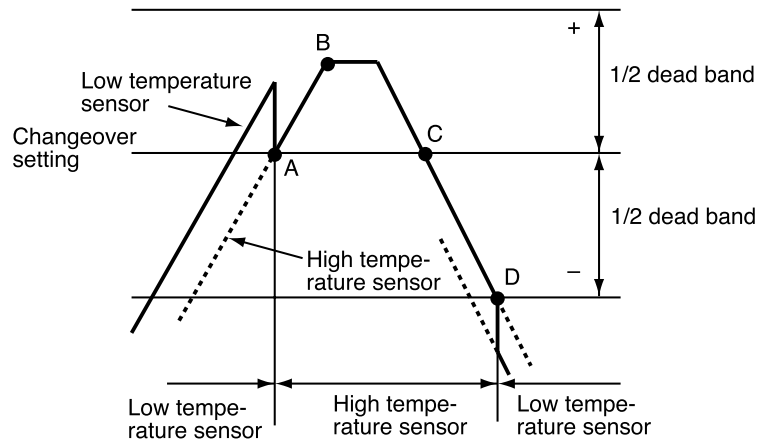

- (1) When the high-temperature sensor senses that the temperature has risen to changeover point A, the channel switches from the low-temperature to the high-temperature sensor.
- (2) No switching is performed at changeover point C when the high-temperature sensor senses that the temperature has only reached point B and does not exceed the upper limit of the dead band.
- (3) When the high-temperature sensor senses that the temperature has dropped to point D the lower limit of the dead band, the channel switches from the high-temperature to the low-temperature sensor.

Example 2:

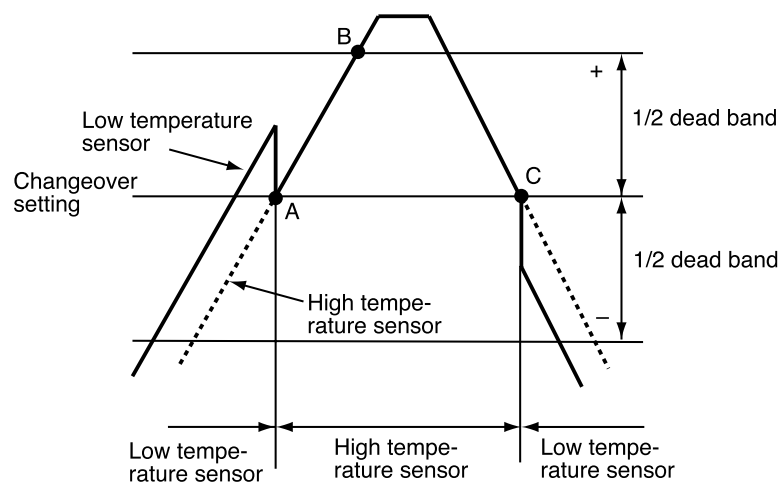

- (1) When the temperature rises and the high-temperature sensor senses that the temperature has risen to changeover point A, the channel switches from the low-temperature sensor to the high-temperature sensor.
- (2) When the high-temperature sensor senses that the temperature has risen above the upper limit of the dead band and reached point B, the channel switches from the high-temperature to the low-temperature sensor at changeover point C.

Example 3:

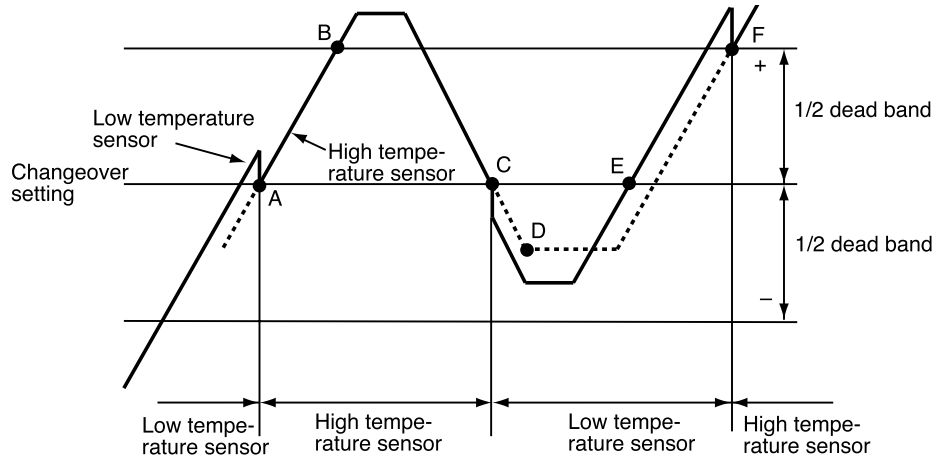

- (1) When the high-temperature sensor senses that the temperature has risen to changeover point A, the channel switches from the low-temperature to the high-temperature sensor.
- (2) When the high-temperature sensor senses that the temperature has risen above the upper limit of the dead band and reached point B, the channel switches from the high-temperature to the low-temperature sensor at changeover point C.
- (3) No switching is performed at changeover point E when the high-temperature sensor senses that the temperature has only dropped to point D and has not gone below the upper limit of the dead band.
- (4) When the high-temperature sensor senses that the temperature has reached point F at the upper limit of the dead band, the channel switches from the high-temperature to the low-temperature sensor at changeover point C.

Example 4:

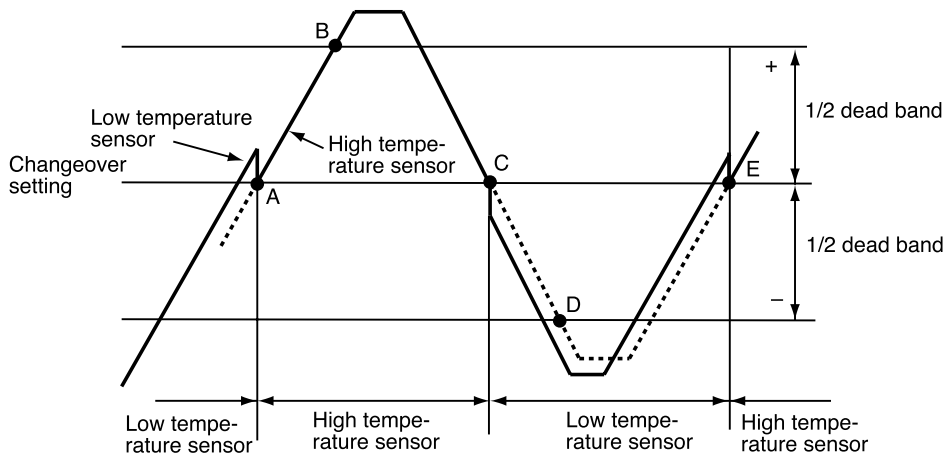

- (1) When the high-temperature sensor senses that the temperature has risen to changeover point A, the channel switches from the low-temperature to the high-temperature sensor.
- (2) When the high-temperature sensor senses that the temperature has risen above the upper limit of the dead band and reached point B, the channel switches from the high-temperature to the low-temperature sensor at changeover point C.
- (3) When the high-temperature sensor senses that the temperature has dropped to point D the lower limit of the dead band, the channel switches from the high-temperature to the low-temperature sensor at changeover point E.

- Automatic changeover B

To combine external switch input conditions with automatic changeover A, enter 2 in setup data setting **C26** and 9 or 10 in one of settings **C71** to **C74**.

When 9 is entered in **C71** to **C74** and the external switch is on, it is tied to channel 1. When it is off, it is possible to switch channels from channel 1 to 2.

When 10 is entered in **C71** to **C74** and the external switch is on, it is tied to channel 2. When it is off, it is possible to switch channels from channel 2 to 1.

Conditions	Result of automatic changeover A operation	CH1			CH2		
	External switch set to 9 (PV1 → PV2)	OFF	ON	Nothing	OFF	ON	Nothing
	External switch set to 10 (PV2 → PV1)	Nothing	OFF	ON	Nothing	OFF	ON
Result of automatic changeover B operation		CH1	CH1	CH2	CH2	CH1	CH2

- Automatic changeover C

Enter 2 in setup data **C26** when the PV to be calculated is the value between the low-temperature sensor and high-temperature sensor in the dead band range. The switch operation is described in the following example.

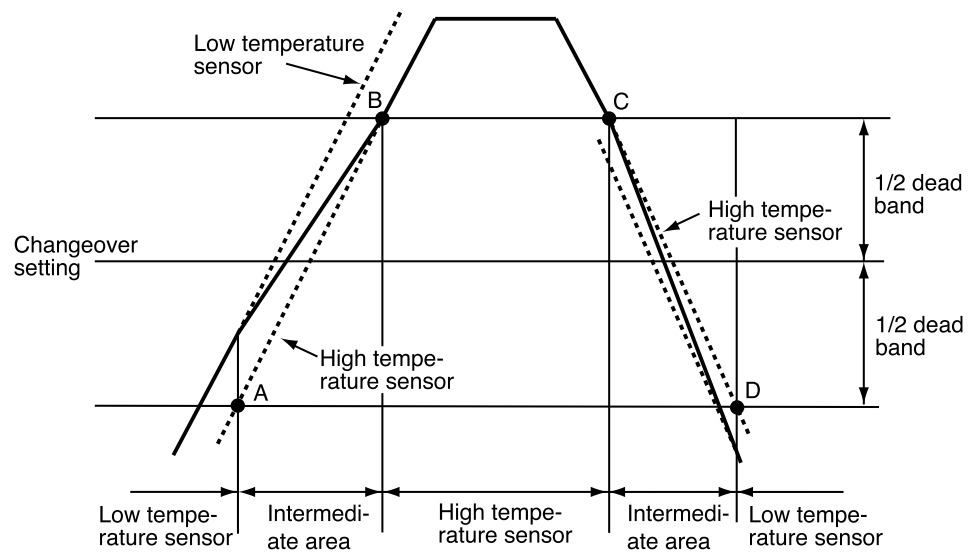

- (1) When the high-temperature sensor senses that the temperature has dropped below point A, the lower dead band limit, the channel switches from the high-temperature sensor to the low-temperature sensor.
- (2) When the high-temperature sensor senses that the temperature has risen to between point A, the lower dead band limit, and point B, the higher dead band limit, the controller calculates the value between the low-temperature sensor and the high-temperature sensor. The ratio of the high-temperature sensor varies between 0% at point A and 100% at point B.
- (3) When the high-temperature sensor senses that the temperature has risen above point B, the higher dead band limit, the channel switches from the low-temperature sensor to the high-temperature sensor.
- (4) When the high-temperature sensor senses that the temperature has dropped below point C and is going towards point D, the controller calculates the value between the low-temperature sensor and the high-temperature sensor.

- NOTE** • When switching between automatic changeover A to C, make sure that the changeover point is set in the overlapping area between the high-temperature and low-temperature sensors and 1/2 inside the deadband.

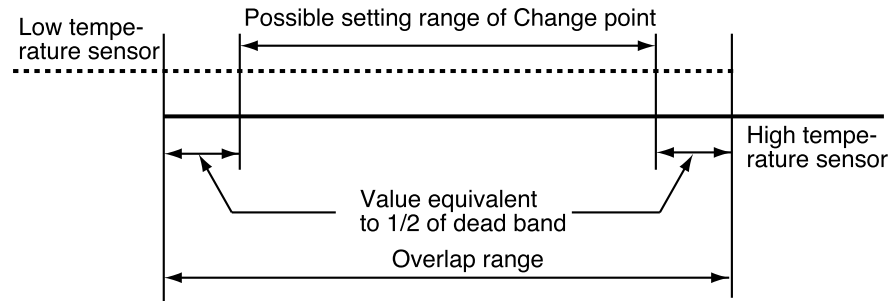

- When there is a temperature difference between the two inputs from high-temperature and low-temperature sensors, PV reflects this but the control output performs a PID computation to prevent a major disturbance from occurring. When a major disturbance occurs in the control output, select automatic changeover C.
- Select setup data setting **C29** when an initial changeover setting is desired at power on during automatic changeover A and B. When set to 0, the power stays off; when set to 1, a switch is made to CH1; and when set to 2 a switch is made to CH2.

5-6 Output Processing Functions

■ Control output

When the controller function is used, the control output is processed as shown below.

● Current output (with setup data C21 set to 1)

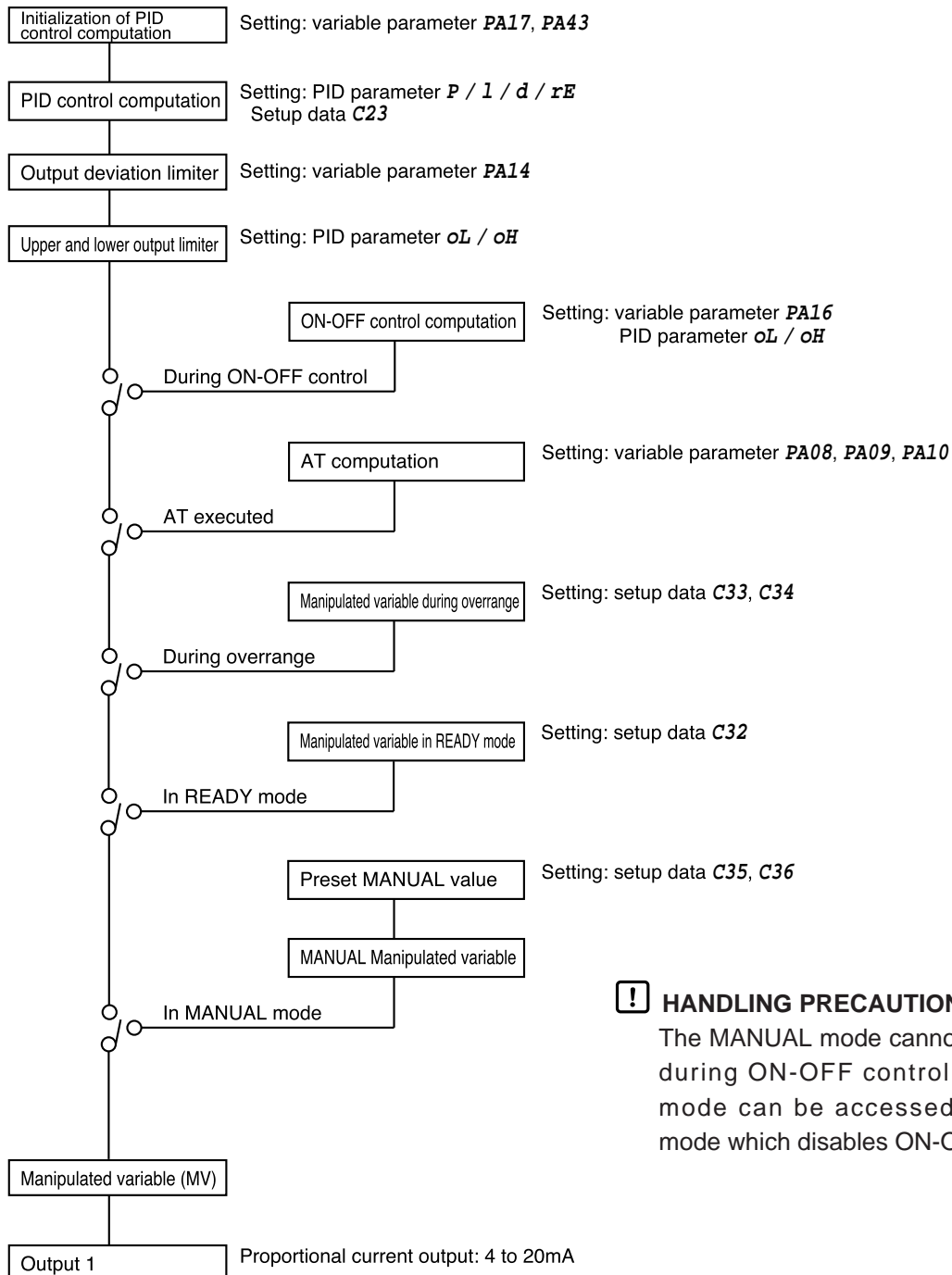

! HANDLING PRECAUTIONS

The MANUAL mode cannot be invoked during ON-OFF control. (MANUAL mode can be accessed in READY mode which disables ON-OFF control.)

● Voltage, Open collector output (with setup data C21 set between 2 to 5)

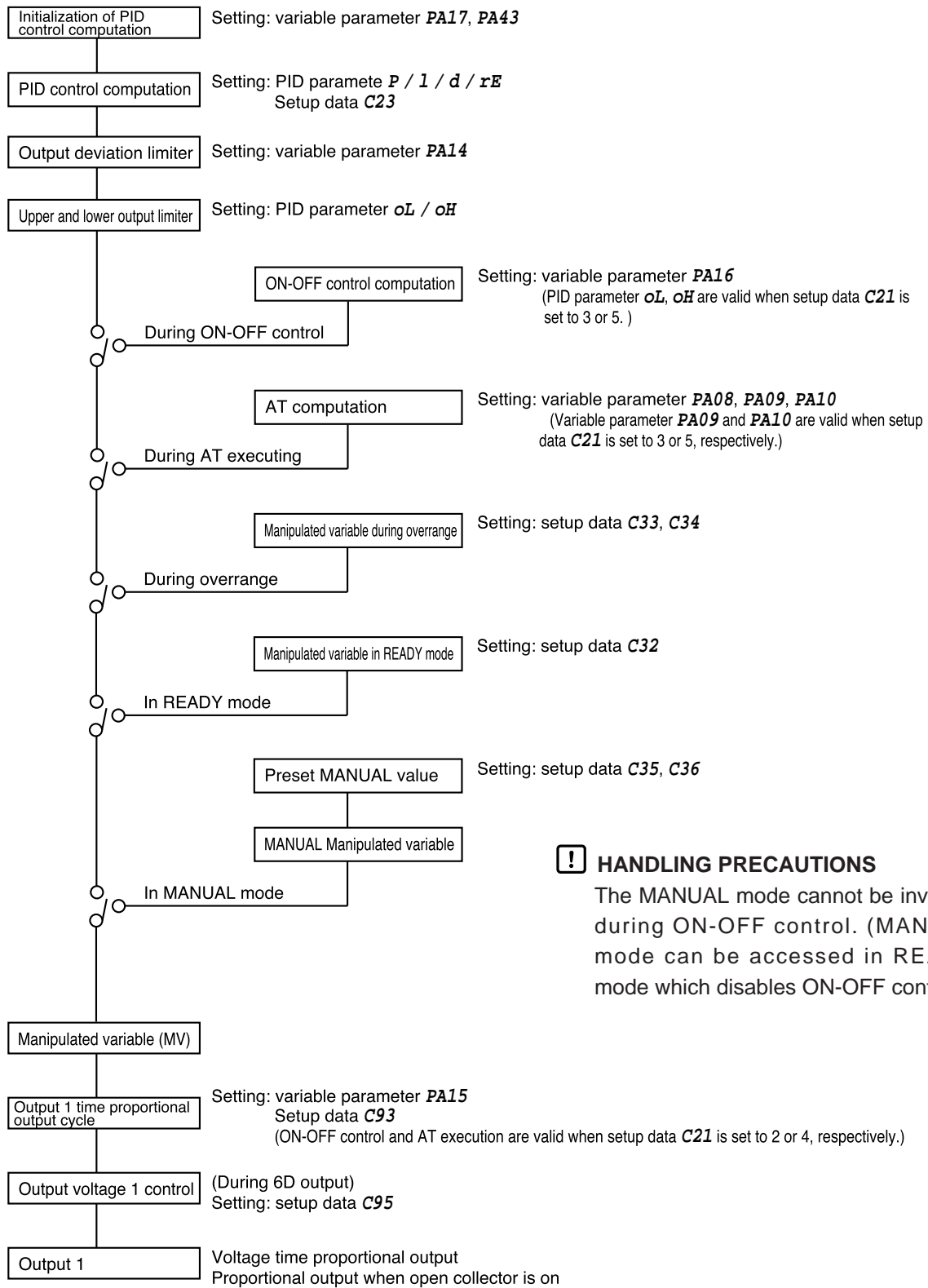

! HANDLING PRECAUTIONS
 The MANUAL mode cannot be invoked during ON-OFF control. (MANUAL mode can be accessed in READY mode which disables ON-OFF control.)

■ SP output

When the programmer function is used (when setup data **C21** is set to 0), SP output is processed as shown below.

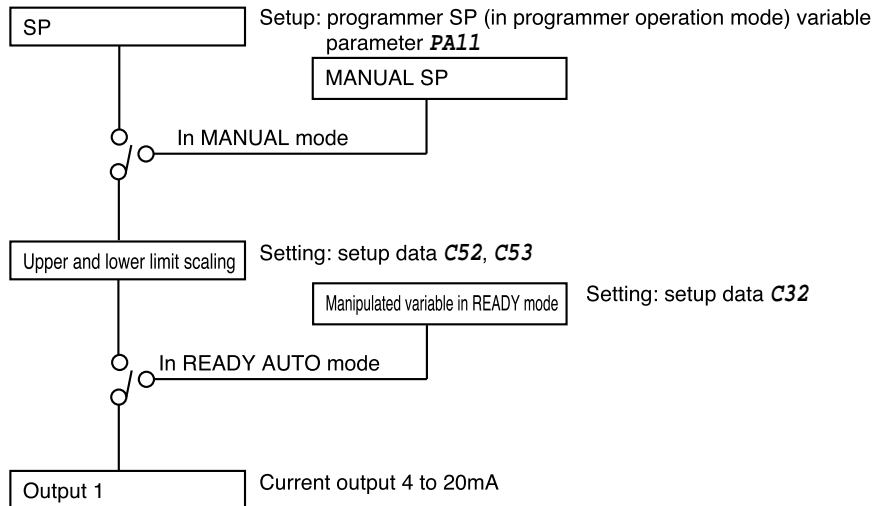

■ Auxiliary output

● Auxiliary output 1

Auxiliary output 1 is processed as shown below by a model with one or two auxiliary output channels.

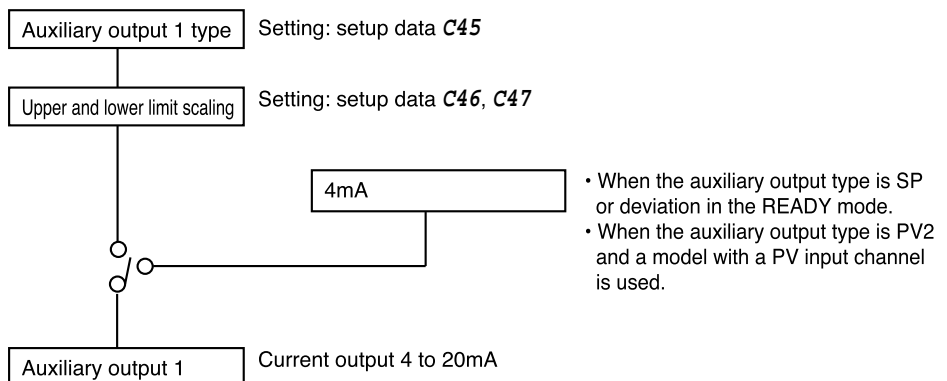

● Auxiliary output 2

Auxiliary output 2 is processed as shown below on a model with two auxiliary output channels.

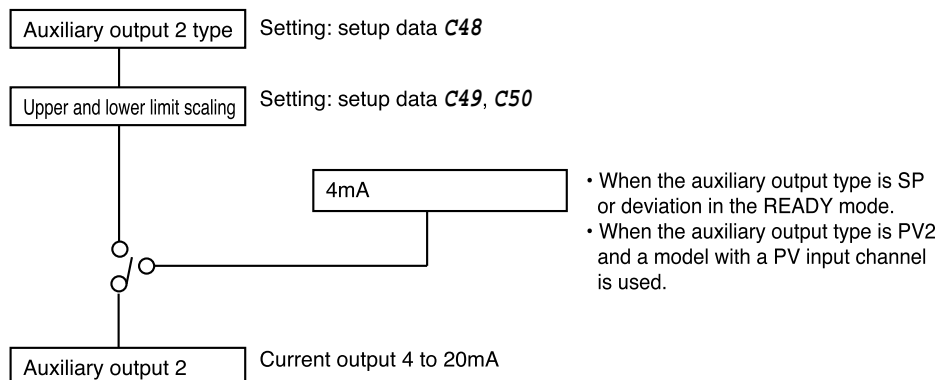

Chapter 6. OPERATION

6-1 Power Supply On

When 100 to 240V AC is applied across terminals (39) and (40) on the DCP551, the display goes on in about 10 seconds and controls and other operations start. When the controller is starting up, the LEDs on the profile display go on at irregular intervals one after the other starting from top right in clock-wise order until the controller becomes ready for operation.

The startup flow procedure is shown below.

●Startup flow procedure

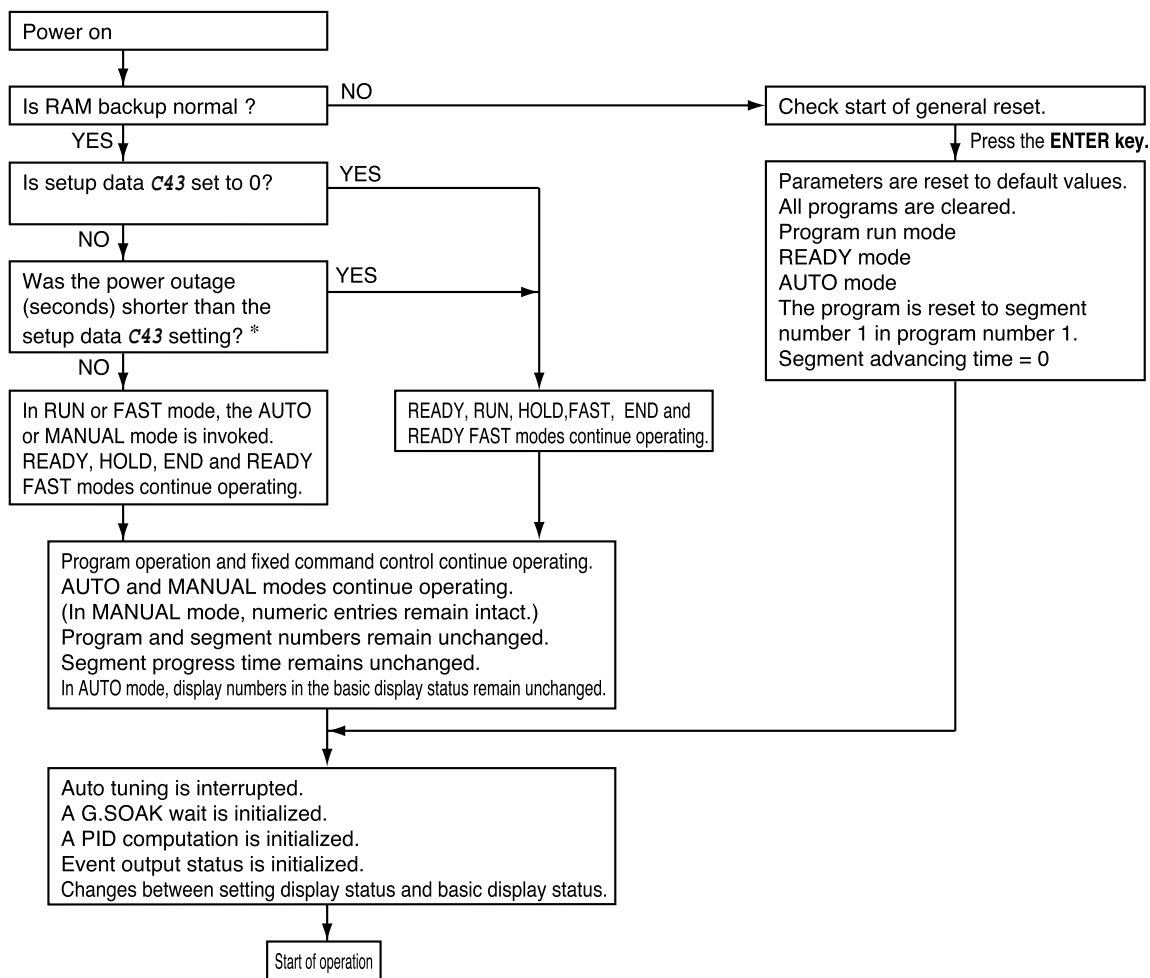

*: The measurement of a power outage may vary by about 10 seconds.

6-2 Basic Display Selection

The console basic display status is comprised of the program number display, segment number display, display panel 1, display panel 2, basic display LEDs and the message panel.

Use the **DISP key** or **MESSAGE key** to cycle through the different displays. The mode display LEDs perform the same functions both in the basic display status and during parameter settings and do not change by pressing the **DISP** or **MESSAGE key**.

The displays and their functions are shown in the figure below.

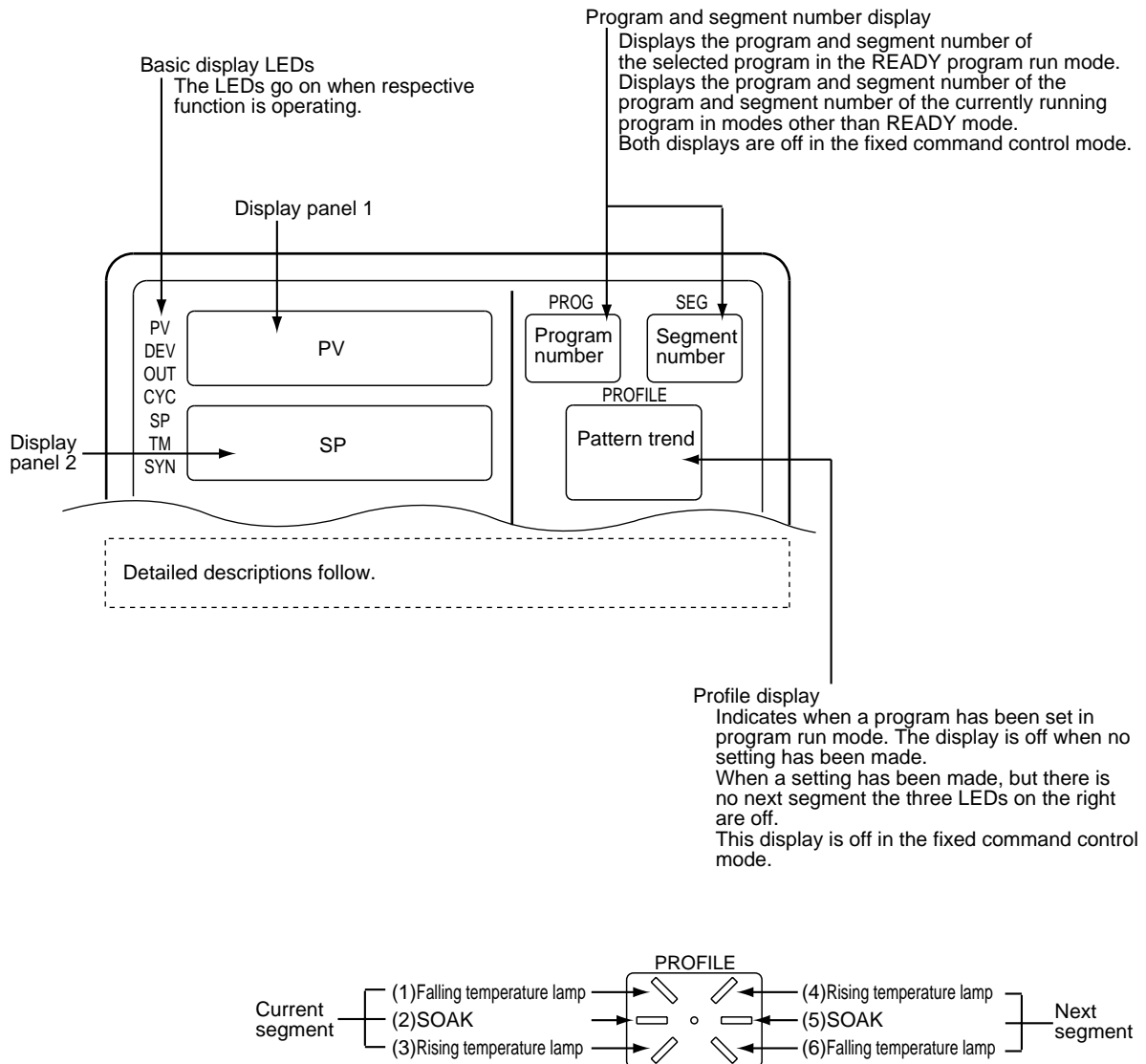

■ Program run mode displays

● DISP key function

The **DISP key** is used to cycle through the displays in the following order: Display A1, display A2, display A3, display A4, display A5, display A6, display A1.

● Display A1

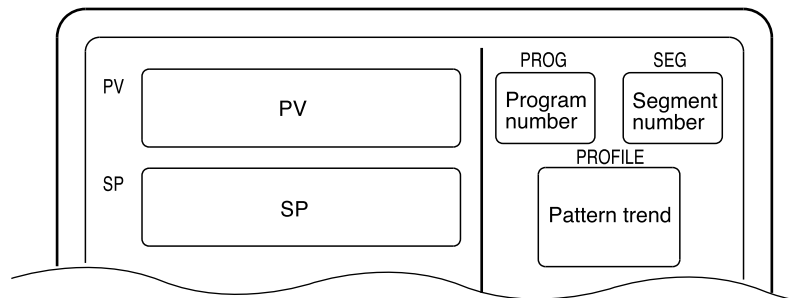

When the programmer function is used in MANUAL mode, the number of digits available for SP recording flashes.

● Display A2

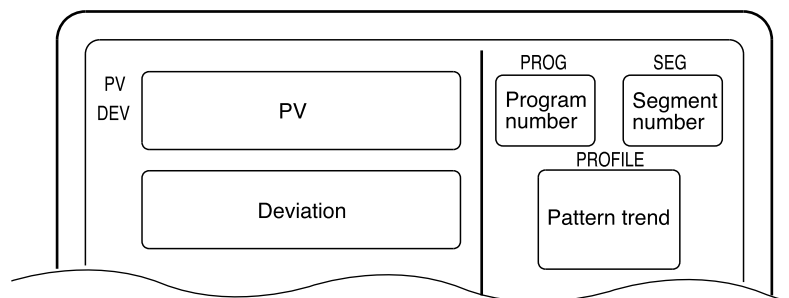

● Display A3

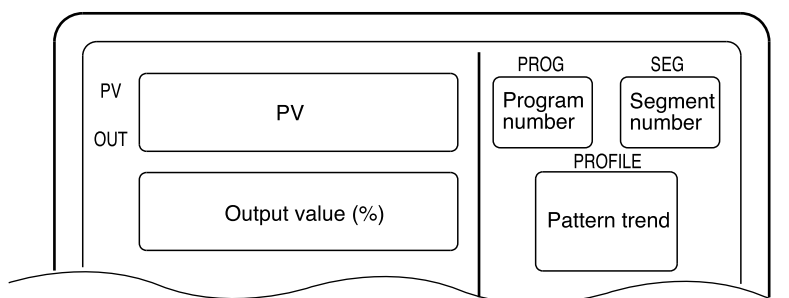

When the controller function is used in MANUAL mode, the number of digits available for output values flashes.

●Display A4

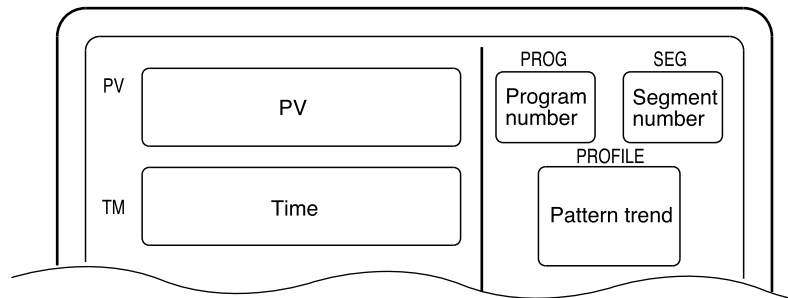

Select Hours and Minutes, Minutes and Seconds or 0.1 Seconds in the time unit setup data. In the setup data, also select Remaining Segment Time or Total Running Time.

●Display A5

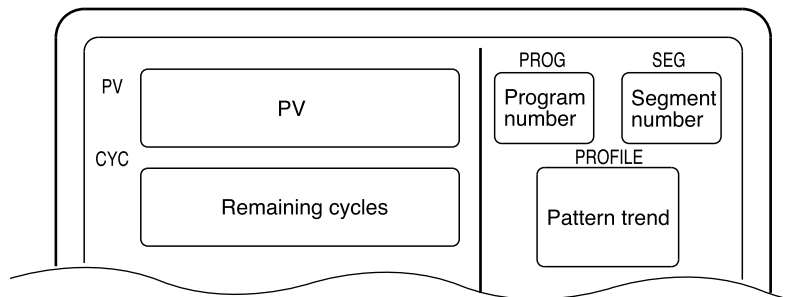

When the remaining number of cycles is 0, cycle operation stops.

●Display A6

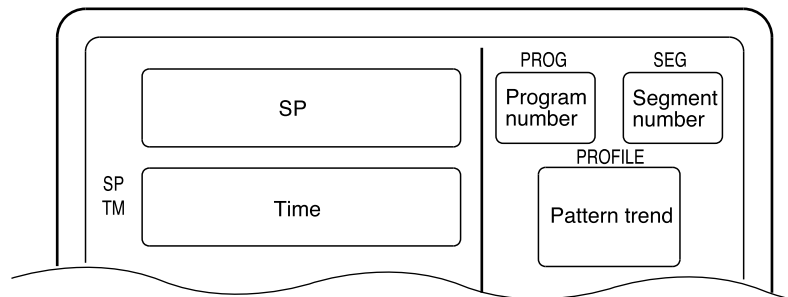

When the programmer function is used in MANUAL mode, the number of digits available for SP recording flashes. Select Hours and Minutes, Minutes and Seconds or 0.1 Seconds in the time unit setup data. In the setup data, also select Remaining Segment Time or Total Running Time.

● Message key function

Cycles through the message panel displays.

- Models with one PV input channel: Display B1, display B2, display B3, display B4, display B5, display B1.
- Models with two PV input channels: Display B1, display B2, display B3, display B4, display B5, display B6, display B1.

● Display B1



● Display B2

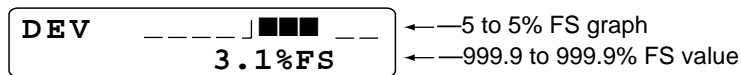

● Display B3

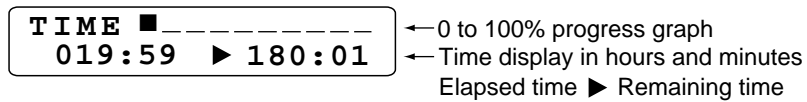

● Display B4

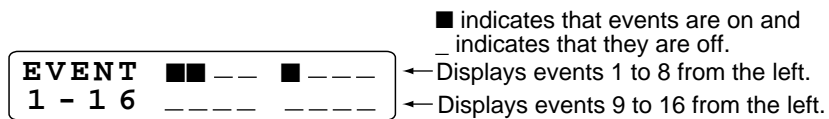

● Display B5

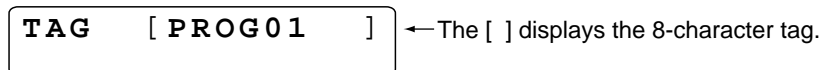

● Display B6

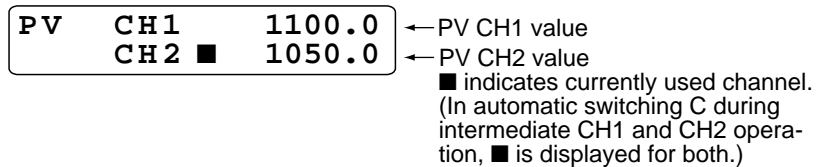

■ Constant value control mode

● DISP key function

The DISP key is used to cycle through the displays in the following order: Display C1, display C2, display C3, display C1.

● Display C1

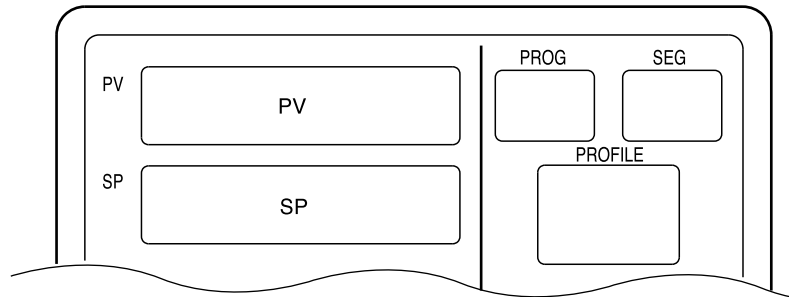

● Display C2

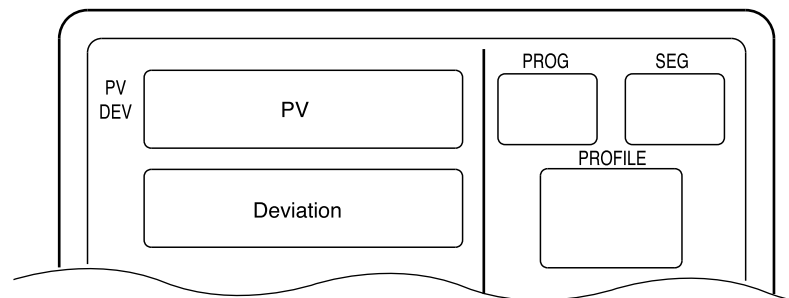

● Display C3

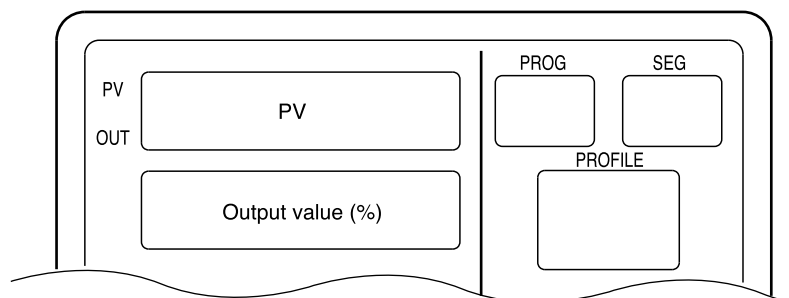

In MANUAL mode, the number of digits available for output values flash.

6-3 Selecting Programs

A total of 99 programs can be selected with the operation keys.

■ Selecting program numbers

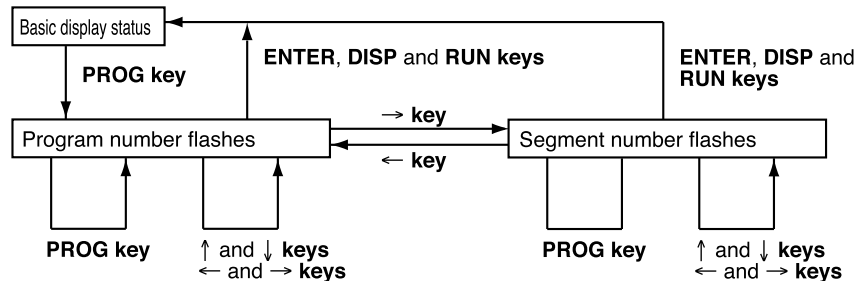

- Press the **PROG key** in the READY program run mode and basic display status. The program number starts to flash.
- Press the **PROG key** when the program or segment number starts flashing to cycle through set program numbers when several programs have been set. The segment number is set to 1.
- Use the **↑** or **↓ key** when the program number is flashing to select a program number regardless of whether a program has been set or not. The segment number is set to 1.
- Use the **↑** or **↓ key** when the segment number is flashing to select a segment number. When no program has been set, only 1 can be selected. When a program has been set, any of the set segments can be selected.
- The message panel displays the program tag when a program or segment number flashes. The 8-character tag display is off when no program has been set.
- Press the **RUN key** to start RUN mode operation from the displayed segment number when the program or segment number is flashing.

! HANDLING PRECAUTIONS

- Programs cannot be selected during external switch input.
- Selections cannot be made in constant value control mode, RUN, HOLD, END and READY FAST modes.

6-4 External Switch Operation

■ External switch input

A total of 16 external switch inputs are available. Each input is called SW1, SW2, etc. up to SW16. (SW: external switch input)

● Types of external switch inputs

SW1 to 4 and SW9 to 16 are tied.

SW5 to 8 functions are selected using setup data **C71** to **C74**.

SW9 to 16 are for program selections. Selections are made by entering BCD code or binary codes in setup data **C75**. When two weights are given for an item, the right weight is for binary figures and the left is for BCD.

External switch number	Function	Detection way
SW1	RUN	Leading edge
SW2	HOLD	Leading edge
SW3	RESET	Leading edge
SW4	ADV	Leading edge
SW5	Selects one of the following functions using setup settings.	
SW6	RAMP-E	Leading edge
SW7	FAST	Leading edge
SW8	Clears G.SOAK using the OR condition.	Status
	Clears G.SOAK using the AND condition.	Status
	MANUAL/AUTO	Leading/trailing edge
	AT start/stop	Leading/trailing edge
	PV1/PV2 (OFF: PV1, ON: PV2)	Status
	AUTO Loading	Leading edge
	PV1 → PV2 standby (See page 5-35.)	Status
PV2 → PV1 standby (See page 5-35.)	Status	
	Normal/Reverse operation	Status
SW9	Selects program number, weight 1	Status
SW10	Selects program number, weight 2	Status
SW11	Selects program number, weight 4	Status
SW12	Selects program number, weight 8	Status
SW13	Selects program number, weight 10 or 16	Status
SW14	Selects program number, weight 20 or 32	Status
SW15	Selects program number, weight 40 or 64	Status
SW16	Selects program number, weight 80 or 0	Status

NOTE

- When G.SOAK is cleared using an OR condition and an external switch is on, or PV enters the G.SOAK width, a G.SOAK wait is cleared.
- When G.SOAK is cleared using an AND condition and an external switch is on and PV enters the G.SOAK width, a G.SOAK wait is cleared.
- A normal or reverse operation is performed according to setup data setting **C23** when the external switch is off. When the external switch is on, a normal or reverse operation that is the reverse of setup data setting **C23** is performed.

■ Selecting programs

- Programs can be selected using the external switches in the READY program run mode.
- Programs are selected using the external switches and the BCD system or the binary system, and are set in setup data **C75**. In the BCD system, four switches SW9 to 12 are used to set the one digit and the four switches SW13 to 16 are used to set the ten digit. In the binary system, seven switches SW9 to 15 are used to set, and the switch SW16 is not used. Settings made with these systems are shown in the tables below.

BCD system (the one digit)		Status									
External switch number	Weight										
SW9	1	OFF	ON	OFF	ON	OFF	ON	OFF	ON	OFF	ON
SW10	2	OFF	OFF	ON	ON	OFF	OFF	ON	ON	OFF	OFF
SW11	4	OFF	OFF	OFF	OFF	ON	ON	ON	ON	OFF	OFF
SW12	8	OFF	OFF	OFF	OFF	OFF	OFF	OFF	OFF	ON	ON
Number selection		0	1	2	3	4	5	6	7	8	9

BCD system (the ten digit)		Status									
External switch number	Weight										
SW13	10	OFF	ON	OFF	ON	OFF	ON	OFF	ON	OFF	ON
SW14	20	OFF	OFF	ON	ON	OFF	OFF	ON	ON	OFF	OFF
SW15	40	OFF	OFF	OFF	OFF	ON	ON	ON	ON	OFF	OFF
SW16	80	OFF	OFF	OFF	OFF	OFF	OFF	OFF	OFF	ON	ON
Number selection		0	10	20	30	40	50	60	70	80	90

Binary system		Status												
External switch number	Weight													
SW9	1	OFF	ON	OFF	ON	OFF	ON		ON	OFF	ON	OFF	ON	
SW10	2	OFF	OFF	ON	ON	OFF	OFF		OFF	ON	ON	OFF	OFF	
SW11	4	OFF	OFF	OFF	OFF	ON	ON		ON	ON	ON	OFF	OFF	
SW12	8	OFF	OFF	OFF	OFF	OFF	OFF		ON	ON	ON	OFF	OFF	
SW13	16	OFF	OFF	OFF	OFF	OFF	OFF		OFF	OFF	OFF	ON	ON	
SW14	32	OFF	OFF	OFF	OFF	OFF	OFF		OFF	OFF	OFF	OFF	OFF	
SW15	64	OFF	OFF	OFF	OFF	OFF	OFF		OFF	OFF	OFF	OFF	OFF	
Number selection		0	1	2	3	4	5	•••	13	14	15	16	17	

Binary system		Status											
External switch number	Weight												
SW9	1		ON	OFF	ON		ON	OFF	ON		ON	OFF	ON
SW10	2		ON	OFF	OFF		ON	OFF	OFF		OFF	ON	ON
SW11	4		ON	OFF	OFF		ON	OFF	OFF		OFF	OFF	OFF
SW12	8		ON	OFF	OFF		ON	OFF	OFF		OFF	OFF	OFF
SW13	16		ON	OFF	OFF		ON	OFF	OFF		OFF	OFF	OFF
SW14	32		OFF	ON	ON		ON	OFF	OFF		ON	ON	ON
SW15	64		OFF	OFF	OFF		OFF	ON	ON		ON	ON	ON
Number selection		•••	31	32	33	•••	63	64	65	•••	97	98	99

! HANDLING PRECAUTIONS

When a program number of 0 is set using the external switch inputs, programs can be selected using the console keys and by transmission.

■ Read timing

● SW1 to 8 timing

SW1 to 8 are read according to the timing in the figure shown below.

- (1) When the input changes from OFF to ON, reading starts within less than 0.2 seconds.
- (2) When the input changes from ON to OFF, reading starts within less than 0.2 seconds.

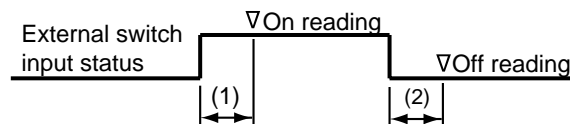

● SW9 to 16 and RUN, FAST (READY FAST) timing

Selecting SW9 to 16 program numbers takes less than 0.4 seconds after a change in input status.

Thus the following timings (1) to (4) must be observed during RUN operations. FAST (READY FAST) operations should follow the same timings.

- (1) Time from number selection to leading edge of the RUN signal : 0.4 seconds or more
- (2) Time from the leading edge of the RUN signal to number selection hold : 0.2 seconds or more
- (3) Time from RUN signal OFF to leading edge of RUN signal : 0.2 seconds or more
- (4) Time from leading edge of RUN signal to RUN signal ON hold : 0.2 seconds or more
- (5) Time from entry of selected number to program number change : 0.4 seconds or less
- (6) Time from leading edge of RUN signal to start of RUN signal : 0.4 seconds or less

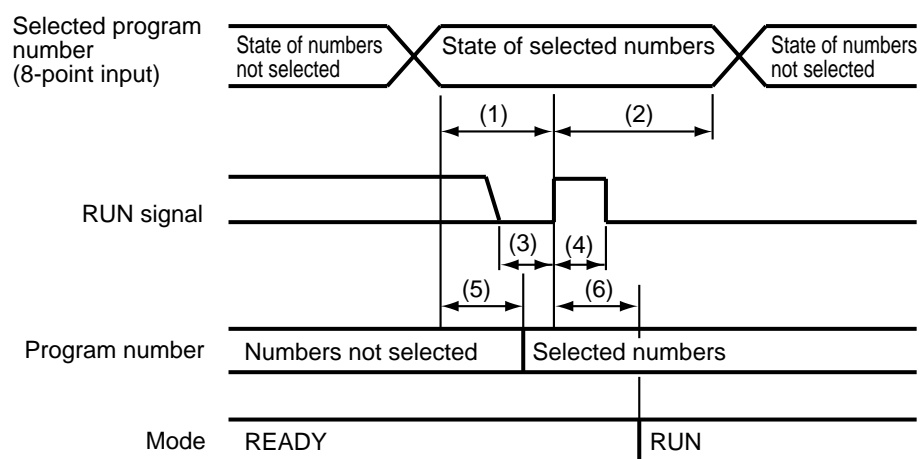

❗ HANDLING PRECAUTIONS

To ensure correct operation, the above read timings should be regarded as minimum time settings in external switch operations.

6-5 Manual Operation and Auto-Tuning

■ Manual operation

The **↑** and **↓** keys can be used to control instrument outputs in the MANUAL mode.

● Controller function operations

When outputs are indicated in the basic display status, only one digit in the output value flashes. Increasing or decreasing the output value using **↑** and **↓** keys causes the actual output to change accordingly. Unlike setting registration, there is no need to press the **ENTER** key.

Use the **←** and **→** keys to move the flashing digit.

Setup data **C35** is used to select smooth and preset output changes when going from AUTO to MANUAL modes.

Changes from MANUAL to AUTO are smooth.

(Note, however, that when the integral time setting for a PID group PID parameter of 0 may cause abrupt changes.)

● Programmer function operations

SP can be set manually when setup data **C21** is set to 0 and programmer functions operate.

When SP is indicated in the basic display status, only one digit in the output value flashes. Increasing or decreasing the SP value using **↑** and **↓** keys causes the actual SP value to change accordingly. Unlike setting registration, there is no need to press the **ENTER** key.

Use the **←** and **→** keys to move the flashing digit.

Regardless of setup data **C35** setting, output changes going from AUTO to MANUAL modes are smooth.

Changes from MANUAL to AUTO program pattern SP are used and abrupt output changes may occur.

■ Auto-tuning (AT)

Set values can automatically be written when using auto-tuning (AT) in the RUN, HOLD, FAST and END modes during AUTO mode operation and PID groups (1 to 9, A1 to A7 or constant value control) are being used.

In READY AUTO mode, the tuning points of PID parameters **tP-A1** to **tP-A7** settings can be used as SP to perform auto-tuning of PID groups A1 to A7 values.

Variable parameter **PA08** allows the following selections:

- 0** : AT is not performed.
 - 1** : A general AT operation of a PID group used in a mode other than READY mode
 - 2** : AT of PID values that do not easily overshoot can be written to a PID group used in a mode other than READY mode.
 - 3** : A standard AT operation is repeatedly performed on PID groups A1 to A7 in READY mode.
 - 4** : Repeated AT of PID values that do not easily overshoot can be written to PID groups A1 to A7 used in READY mode.
- During auto-tuning, program run time stops. Thus the RUN and FAST modes are changed to the HOLD mode.

- Auto-tuning always calculates the excess time and limit sensitivity of thread for two limit cycles and calculates PID values using characteristics equations, then automatically writes the results.
- The setup data **C21** setting changes the upper and lower output limit used during auto-tuning.
C21 setting of 1, 3 or 5 causes the lower output limit to be determined by variable parameter **PA09** and the upper output limit to be determined by **PA10**.
C21 setting of 2 or 4, lower output limit is off and the upper output limit is on.
- The point at which output reverses (lower limit \Leftrightarrow upper limit) during auto-tuning is determined from the SP and PV values at AT startup as follows.

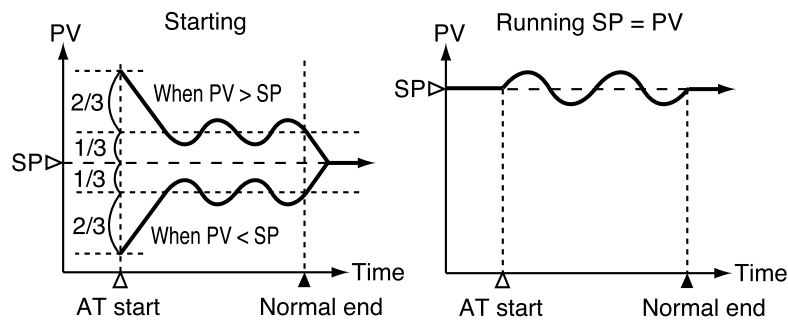

- Auto-tuning performed using a variable parameter **PA08** setting of 3 or 4 causes auto-tuning to be performed on SP, PID parameters **tP-A1** to **tP-A7**, in order.

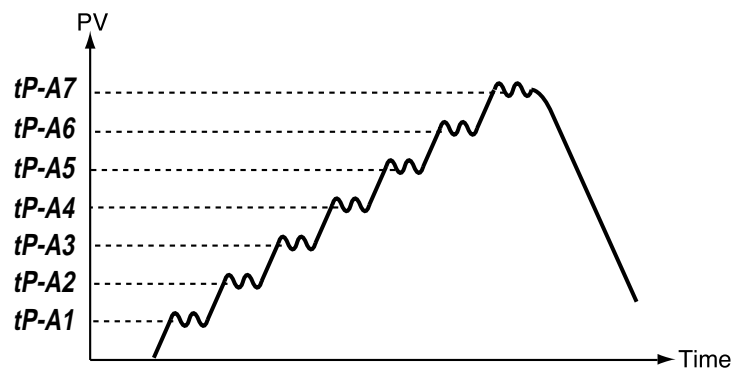

- Auto-tuning can be started by the **AT key**, external switch input and by transmission. The **AT LED** flashes during auto-tuning.
- Auto-tuning terminates without writing PID constants and the **AT LED** goes off when any of the following conditions occur.
 - Operation is terminated by pressing of the **AT key**.
 - Operation is terminated by an external switch input.
 - Operation is terminated by transmission.
 - Mode change occurs. (When the MANUAL mode is invoked; the READY mode is invoked by setting **PA08** to 1 or 2, the RUN mode is invoked by setting **PA08** to 3 or 4.)
 - When PV goes outside the range.

! HANDLING PRECAUTIONS

- Auto-tuning does not operate normally when the equipment to be controlled is not connected.
- The time required for auto-tuning depends on the equipment controlled.
- When auto-tuning is executed, control is terminated , lower and higher limit outputs are repeated several times and PV fluctuates. When equipment failure may be caused by PID fluctuations, set the PID value manually.
If just PID value can not be got in case of control object, sets PID value with manual.
- A variable parameter **PA08** setting makes values set at the start of auto-tuning valid. A change in the **PA08** setting made during auto-tuning execution is ignored. The new value is valid in the next auto-tuning operation.

Chapter 7. PARAMETER SETUP

7-1 Parameter Setu

Parameter settings can be changed when the DCP551 is in the normal display mode.

When not in the normal display mode, press the **DISP key** to invoke it.

■ Selecting parameter settings groups

In the normal display mode, the keys listed in the table below can be used to select settings groups and individual items in these groups.

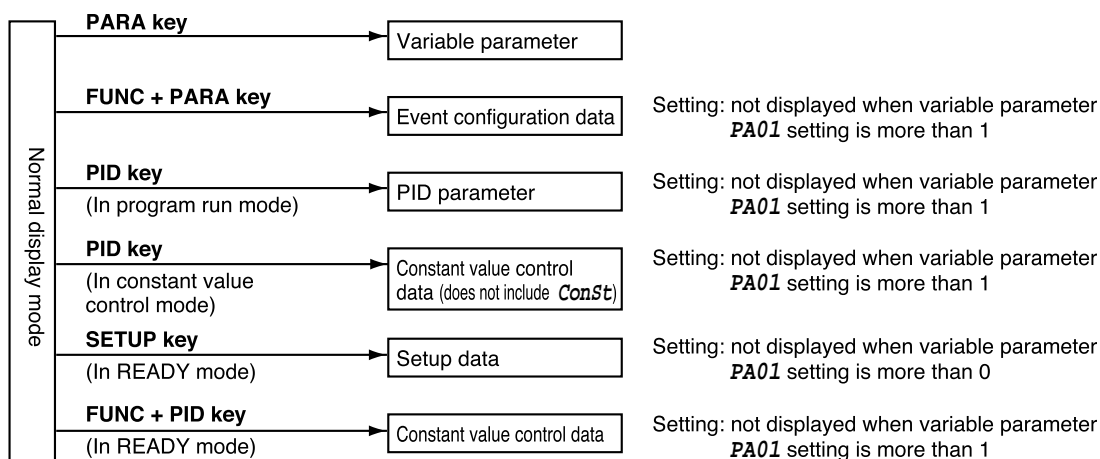

Individual items in each settings group are listed below.

- Variable parameter : **PA01**
- Event configuration data : **E01-t**
- PID parameters : **P-1** in READY mode
Use **P** setting in the used PID group in modes other than READY mode.
- Setup data : **C01**
- Constant value control data : **Const** when using **FUNC + PID key**
SP when using the **PID key** in constant value control mode

■ Progression of individual items in parameter settings

The item codes for individual (specific) items are shown on display panel 1, their set values are shown on display panel 2 and their mnemonic codes are shown on the message panel.

Individual items are displayed in the vertical-horizontal matrix shown on page7-3, with matrix sizes varying according to settings group. The **↑ key**, **↓ key**, **← key** and **→ key** are used to cycle through individual items.

The **PARA key** (valid for variable parameters and event configuration data), **PID key** (valid for PID parameters and constant value control data) or the **SETUP key** (valid for setup data) allow you to search for displayable items in ascending order of item number.

■ Modifying individual items and exiting the setting mode

Pressing the **ENTER key** while an individual item is displayed causes the set value to flash and enables the registration state. At this point, the **↑ key** and **↓ key** allow you to increase or decrease the values, while the **← key** and **→ key** move the digit positions on the display at which the values flash.

Pressing the **ENTER key** after the flashing number has been changed to the desired value stops the flashing, the number reverts to the on state and the new setting is stored in internal memory.

Modification of settings is terminated by pressing either the **PARA key** (valid for variable parameters and event configuration data), **PID key** (valid for PID parameters and constant value control data), **SETUP key** (valid for setup data) or **DISP key**. Pressing the **PARA key**, **PID key** or **SETUP key** moves the cursor to the next item stops the flashing and the number reverts to its normal on state.

Pressing the **DISP key** enables the normal display mode.

Should display panel 2 show during display of an individual item or pressing the **ENTER key** not enable the registration state, it means that settings cannot be made or modified for that item.

! HANDLING PRECAUTIONS

- When **PA01** is set to more than 1 in a variable parameter setting, **PA03** and items beyond are not displayed. **PA03** and items beyond cannot be changed when **PA02** is set to more than 1.
- Event configuration data settings cannot be changed when **PA02** is set to a value more than 1. Also, when **PA02** is set to 0 or 1, the event type setting and some auxiliary settings (output points of code events) cannot be changed.
- PID parameter settings cannot be changed when **PA02** is set to 4 or 5.
- Setup data settings cannot be changed when **PA02** is set to a value more than 1 and cannot be displayed in modes other than the READY mode.
- The constant value control data setting cannot be changed when **PA02** is set to 4 or 5. And, since the **FUNC** and **PID keys** are invalid in modes other than the READY mode, a **Const** setting cannot be displayed or changed.

• Example of individual item matrix (setup data)

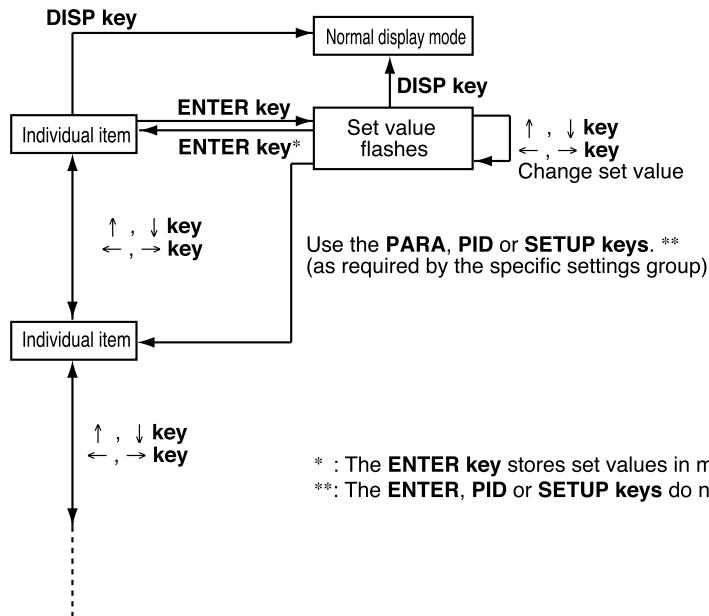
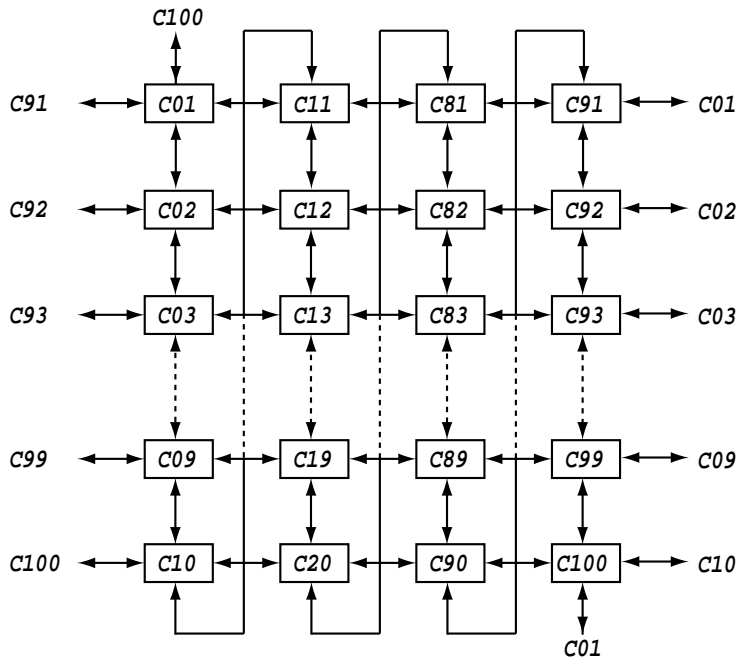

7-2 Parameter Setting List



NOTE

“PVU (PV1)”, “PVU (PV2)” and “SPU” used in the “Factory Default Settings” and “User Settings” columns in the lists on the following pages have the following meaning.

PVU (PV1): When the PV1 range type (setup data setting **C01**) is a thermocouple or resistance temperature detector, the PV1 decimal point position (setup data setting **C03**) causes the decimal point position to change.

When the PV range type is linear, the PV1 linear decimal point position (setup data setting **C04**) causes the decimal point position to change.

For example, in a decimal point position of 1,

–19999 PVU (PV1) becomes –19999.9 and +20000 PVU (PV1) becomes +2000.0.

PVU (PV2): Like PVU (PV1), a PV2 range type (setup data setting **C11**), a PV2 decimal point position (setup data setting **C13**) and a PV2 linear decimal point position (setup data setting **C14**) causes the decimal point position to change.

SPU : The SPU decimal point position (setup data setting **C65**) causes the decimal point position to change.

For example a decimal point position of 2,

–19999 SPU becomes –199.99 and +20000 SPU becomes +200.00.

■ Variable parameter setting

No.	Item code	Item	Factory default settings	User settings	Settings and descriptions
1	PA 01	Keylock	0		0: Keylock disabled 1: Display of setup data settings disabled 2: Display of all settings disabled 3: Display of all settings disabled. Operation keys disabled [Description:] PA01 can be displayed and changed regardless of PA01 and PA02 settings.
2	PA 02	Memory protect	0		0: Disabled 1: Program settings are protected 2: Setup, variable parameters and event configurations are protected. 3: Setup, variable parameters and event configurations are protected. 4: Setup, variable parameters and event configurations are protected. 5: Program settings and all parameter settings are protected. [Description:] PA02 can be displayed and changed regardless of PA01 and PA02 settings.
3	PA 03	Unused	–		[Description:]
4	PA 04	Unused	–		“-----”is displayed and setting cannot be performed.
5	PA 05	Program auto load	0		1: ON 2: OFF
6	PA 06	Unused	–		[Description:]
7	PA 07	Unused	–		“-----”is displayed and setting cannot be performed.
8	PA 08	Auto-tuning	0		0: AT not performed 1: Standard AT performed on currently used PID group in mode other than READY mode. 2: AT writing overshoot-proof PID values to currently used PID groups in mode other than READY mode performed. 3: Standard AT performed on PID groups A1 to A7 in READY mode. 4: AT writing overshoot-proof PID values to PID groups A1 to A7 in READY mode continuously performed.
9	PA 09	Auto-tuning MV lower limit	0.0		–5.0% to upper limit [Description:] Valid when setup data C21 setting is set to 1, 3, 5.
10	PA 10	Auto-tuning MV upper limit	100.0		Lower limit to +105% [Description:] Valid when setup data C21 setting is set to 1, 3, 5.
11	PA 11	SP bias	0 SPU		–10000 to +10000 SPU
12	PA 12	PV1 digital filter	0.0		0.0 to 120.0sec
13	PA 13	PV1 bias	0 PVU		–1000 to +1000 PVU (PV1)
14	PA 14	Manipulated variable deviation limit	110.0		0.1 to 110.0% OUT/0.1sec
15	PA 15	Time proportional output cycle	10		1 to 240sec
16	PA 16	On-off control differential	50 SPU		0 to +1000 SPU
17	PA 17	PID computation initialize manipulated variable	0.0		–5.0 to +105.0%
18	PA 18	Unused	-----		[Description:]
19	PA 19	Unused	-----		“-----”is displayed and setting cannot be performed.
20	PA 20	Unused	-----		
21	PA 21	Unused	-----		
22	PA 22	PV2 digital filter	0.0		0.0 to 120.0sec [Description:] “-----”is displayed and setting cannot be performed on model with one PV input channel.
23	PA 23	PV2 bias	0 PVU		–1000 to +1000 PVU (PV2) [Description:] “-----”is displayed and setting cannot be performed on model with one PV input channel.

No.	Item code	Item	Factory default settings	User settings	Settings and descriptions
24	PA 24	Unused	----		[Description:] "-----" is displayed and setting cannot be performed.
25	PA 25	Unused	----		
26	PA 26	Unused	----		
27	PA 27	Unused	----		
28	PA 28	Unused	----		
29	PA 29	Unused	----		
30	PA 30	Unused	----		
31	PA 31	Event on delay Group 1 event number	0		0 to 16 [Description:] A setting of 0 generates no delay.
32	PA 32	Event on delay Group 1 delay time	0.0		0.0 to 3000.0sec [Description:] When PA31 is set to 0, "-----" is displayed and setting cannot be performed.
33	PA 33	Event on delay Group 2 event number	0		0 to 16 [Description:] A setting of 0 generates no delay.
34	PA 34	Event on delay Group 2 delay time	0.0		0.0 to 3000.0sec [Description:] When PA33 is set to 0, "-----" is displayed and setting cannot be performed.
35	PA 35	Event on delay Group 3 event number	0		0 to 16 [Description:] A setting of 0 generates no delay.
36	PA 36	Event on delay Group 3 delay time	0.0		0.0 to 3000.0sec [Description:] When PA35 is set to 0, "-----" is displayed and setting cannot be performed.
37	PA 37	Event on delay Group 4 event number	0		0 to 16 [Description:] A setting of 0 generates no delay.
38	PA 38	Event on delay Group 4 delay time	0.0		0.0 to 3000.0sec [Description:] When PA37 is set to 0, "-----" is displayed and setting cannot be performed.
39	PA 39	FAST X	0		0 : 2X 1 : 10X 2 : 60X 3 : 120X [Description:] When setup data C62 is set to 1 (program time unit: minutes, seconds), settings 3 and 4 produce a speed of 10 X. When C62 is set to 2 (program time unit: 0.1sec), the FAST mode is not available.
40	PA 40	Unused	----		[Description:] "-----" is displayed and setting cannot be performed.
41	PA 41	EG1 LED display event number	0		0 to 16 [Description:] A setting of 0 turns off the EG1 LED.
42	PA 42	EG2 LED display event number	0		0 to 16 [Description:] A setting of 0 turns off the EG2 LED.
43	PA 43	PID computation initialize	0		0: No initialization during advance processing and PID group change. 1: Initializes during advance processing but not during PID group change. 2: No initialization during advance processing but initializes
44	PA 44	Unused	----		[Description:] "-----" is displayed and setting cannot be performed.
45	PA 45	Unused	----		
46	PA 46	G.SOAK time	2.0		0.1 to 60.0sec
47	PA 47	Unused	----		
48	PA 48	Unused	----		
49	PA 49	Unused	----		

No.	Item code	Item	Factory default settings	User settings	Settings and descriptions
50	PA 50	Unused	----		Compensation point No. 1 : PV1 range lower limit value (tied) Compensation points No. 2 to 9 : -19999 to +20000 PVU (PV1) Compensation point No. 10 : PV1 range upper limit value (tied) Compensation amount No. 1 to 10: -1000 to +1000 PVU (PV1) [Description:] When setup data C30 is set to 0, 2, “-----” is displayed and setting cannot be performed. Compensation point No. 1 and No. 10 are automatically changed during a PV1 range change.
51	PA 51	PV1 equalizer compensation point No. 1	Range lower limit value		
52	PA 52	PV1 equalizer compensation amount No. 1	0 PVU		
53	PA 53	PV1 equalizer compensation point No. 2	500 PVU		
54	PA 54	PV1 equalizer compensation amount No. 2	0 PVU		
55	PA 55	PV1 equalizer compensation point No. 3	1000 PVU		
56	PA 56	PV1 equalizer compensation amount No. 3	0 PVU		
57	PA 57	PV1 equalizer compensation point No. 4	1500 PVU		
58	PA 58	PV1 equalizer compensation amount No. 4	0 PVU		
59	PA 59	PV1 equalizer compensation point No. 5	2000 PVU		
60	PA 60	PV1 equalizer compensation amount No. 5	0 PVU		
61	PA 61	PV1 equalizer compensation point No. 6	2500 PVU		
62	PA 62	PV1 equalizer compensation amount No. 6	0 PVU		
63	PA 63	PV1 equalizer compensation point No. 7	3000 PVU		
64	PA 64	PV1 equalizer compensation amount No. 7	0 PVU		
65	PA 65	PV1 equalizer compensation point No. 8	3500 PVU		
66	PA 66	PV1 equalizer compensation amount No. 8	0 PVU		
67	PA 67	PV1 equalizer compensation point No. 9	4000 PVU		
68	PA 68	PV1 equalizer compensation amount No. 9	0 PVU		
69	PA 69	PV1 equalizer compensation point No. 10	Range upper limit value		
70	PA 70	PV1 equalizer compensation amount No. 10	0 PVU		
71	PA 71	PV2 equalizer compensation point No. 1	Range lower limit value		Compensation point No. 2 : PV2 range lower limit value (tied) Compensation points No. 2 to 19 : -19999 to +20000 PVU (PV2) Compensation point No. 20 : PV2 range upper limit value (tied) Compensation amount No. 1 to 20 : -1000 to +1000 PVU (PV2) [Description:] When setup data C30 is set to 0, 1, “-----” is displayed and setting cannot be performed. Compensation point No. 1 and No. 20 are automatically changed during a PV2 range change. Not displayed on a model with one PV input channel.
72	PA 72	PV2 equalizer compensation amount No. 1	0 PVU		
73	PA 73	PV2 equalizer compensation point No. 2	500 PVU		
74	PA 74	PV2 equalizer compensation amount No. 2	0 PVU		
75	PA 75	PV2 equalizer compensation point No. 3	1000 PVU		
76	PA 76	PV2 equalizer compensation amount No. 3	0 PVU		
77	PA 77	PV2 equalizer compensation point No. 4	1500 PVU		
78	PA 78	PV2 equalizer compensation amount No. 4	0 PVU		
79	PA 79	PV2 equalizer compensation point No. 5	2000 PVU		
80	PA 80	PV2 equalizer compensation amount No. 5	0 PVU		
81	PA 81	PV2 equalizer compensation point No. 6	2500 PVU		
82	PA 82	PV2 equalizer compensation amount No. 6	0 PVU		
83	PA 83	PV2 equalizer compensation point No. 7	3000 PVU		
84	PA 84	PV2 equalizer compensation amount No. 7	0 PVU		
85	PA 85	PV2 equalizer compensation point No. 8	3500 PVU		
86	PA 86	PV2 equalizer compensation amount No. 8	0 PVU		
87	PA 87	PV2 equalizer compensation point No. 9	4000 PVU		
88	PA 88	PV2 equalizer compensation amount No. 9	0 PVU		
89	PA 89	PV2 equalizer compensation point No. 10	4500 PVU		
90	PA 90	PV2 equalizer compensation amount No. 10	0 PVU		
91	PA 91	PV2 equalizer compensation point No. 11	5000 PVU		
92	PA 92	PV2 equalizer compensation amount No. 11	0 PVU		
93	PA 93	PV2 equalizer compensation point No. 12	5500 PVU		
94	PA 94	PV2 equalizer compensation amount No. 12	0 PVU		
95	PA 95	PV2 equalizer compensation point No. 13	6000 PVU		
96	PA 96	PV2 equalizer compensation amount No. 13	0 PVU		

No.	Item code	Item	Factory default settings	User settings	Settings and descriptions
97	PA 97	PV2 equalizer compensation point No. 14	6500 PVU		
98	PA 98	PV2 equalizer compensation amount No. 14	0 PVU		
99	PA 99	PV2 equalizer compensation point No. 15	7000 PVU		
100	PA100	PV2 equalizer compensation amount No. 15	0 PVU		
101	PA101	PV2 equalizer compensation point No. 16	7500 PVU		
102	PA102	PV2 equalizer compensation amount No. 16	0 PVU		
103	PA103	PV2 equalizer compensation point No. 17	8000 PVU		
104	PA104	PV2 equalizer compensation amount No. 17	0 PVU		
105	PA105	PV2 equalizer compensation point No. 18	8500 PVU		
106	PA106	PV2 equalizer compensation amount No. 18	0 PVU		
107	PA107	PV2 equalizer compensation point No. 19	9000 PVU		
108	PA108	PV2 equalizer compensation amount No. 19	0 PVU		
109	PA109	PV2 equalizer compensation point No. 20	Range upper limit value		
110	PA110	PV2 equalizer compensation amount No. 20	0 PVU		
111	PA111	PV1 ratio	1.000		0.001 to 9.999 [Description:] Not displayed on a model with one PV channel.
112	PA112	PV2 ratio	1.000		0.001 to 9.999 [Description:] Not displayed on a model with one PV channel.
113	PA113	Unused	-----		[Description:] Not displayed on a model with one PV input channel.
114	PA114	Unused	-----		Displays "-----" on a model with two PV input channels.
115	PA115	Unused	-----		
116	PA116	Unused	-----		
117	PA117	Unused	-----		
118	PA118	Unused	-----		
119	PA119	Unused	-----		
120	PA120	Unused	-----		

■ Detailed information on variable parameters

● **PA01** (keylock)

- 0: keylock disabled
- 1: display of setup data setting disabled
- 2: display of all settings disabled
- 3: display of all settings disabled. Operation keys disabled

- The following keys are disabled when **PA01** is set to 1.

Normal display mode:

SETUP key (setup data setting)
FUNC + CLR + MESSAGE keys (general reset)

- The following keys are disabled when **PA01** is set to 2.

Normal display mode:

SETUP key (setup data setting)
FUNC + CLR + MESSAGE keys (general reset)
FUNC + PARA keys (event configuration data setting)
PID key (PID parameter setting/constant value control data setting)

FUNC + PID keys (constant value control data setting)

FUNC + PROG keys (program setting)

↑ + PROG keys (program copy)

LOAD key (memory card load)

SAVE key (memory card save)

- The following keys are disabled when **PA01** is set to 3 or to 2.

Normal display mode:

PROG key (program selection)

RUN/HOLD key (RUN operation/HOLD operation)

PROG + RUN/HOLD keys (RESET operation)

PROG + DISP keys (ADV operation)

FUNC + → keys (FAST operation)

A/M key (AUTO operation/MANUAL operation)

AT key (AT start, AT cancel)

Note, however, that in the normal display mode in MANUAL mode MV (controller) and SP (programmer) can be changed.

● **PA02** (memory protect)

- 0 : disabled
- 1 : program settings are protected
- 2 : setup, variable parameters and event configuration settings are protected
- 3 : setup, variable parameters, event configuration settings and program settings are protected
- 4 : setup, variable parameters, event configuration settings and PID parameter settings are protected
- 5 : program settings and all parameter settings are protected

- When **PA02** is set to $\neq 0$ (protect on), a general reset cannot be performed.

- When program settings are protected, it is not possible to copy programs or load programs from a memory card.
- When PID parameters are protected, Constant value control data is also protected.
- When settings are protected by setup data, variable parameters, event configurations and PID parameters, they cannot be loaded from a memory card.

● **PA05 (program autoload)**

- 0 : OFF
- 1 : ON

- When **PA05** is set to 1 and a memory card is inserted and press **LOAD key**, display panel 1 shows “**AUTO**”, display panel 2 shows “**LOAD**” and program file No. 1 is read to program No. 1 in the DCP551. This operation is called “ program autoload”.
- A load operation other than a program autoload that is started using the **LOAD key** can only be performed when **PA05** is set to 0.
- A program autoload using the external switches can be performed when **PA05** is set to 0 or 1.

● **PA14 (manipulated variable deviation rate limit)**

When output deviation (%) after a PID computation is larger than the set limit value, the controller limits the output deviation both of the increase or decrease to the set value. The following example shows the actual deviation change when the deviation limit is set to 0.5% and the manipulated variable changes from 20% to 22%. When the set value is 0.5% per 0.1 sec, the output becomes 22% after 0.4 sec.

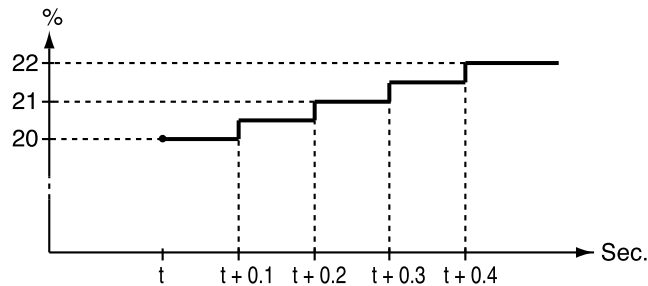

● **PA16 (ON-OFF control differential)**

When the PID group number is set to ON-OFF or **P** is set to 0.0, ON-OFF control is on and a value for the differential between the two operations is set.

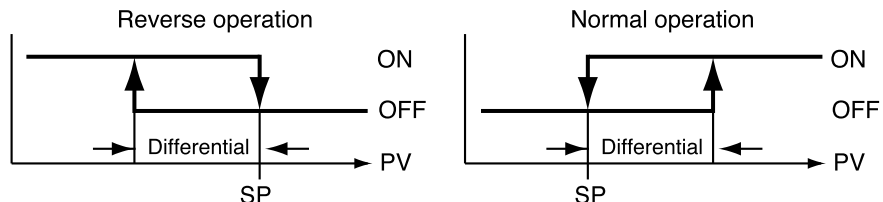

● **PA17 (PID computation initialize manipulated variable)**

Under the conditions listed below, a PID computation starts using the value set in **PA17**.

- When there is a mode change from READY AUTO to RUN AUTO.
- When the controller is powered up in RUN (or HOLD, FAST, END) AUTO mode.
- When auto-tuning ends.

Since the PV, SP and PID parameters affect a PID computation, the first manipulated variable of a PID computation may not be the same as the value set in **PA17**.

● **PA31 to PA38 (event on delay groups 1 to 4, event/delay time)**

- On delay can be performed on up to 4 events.
- **PA31**, **PA33**, **PA35** and **PA37** determine which events are to be processed.
- In a code event involving several event outputs, event on delay has to be set separately for each output.
- All processes including event output standby on/off are processed before on delay processing. When the event output ON condition remains on for longer than the on delay time, the event output stays on.
- This is shown in the diagram below.

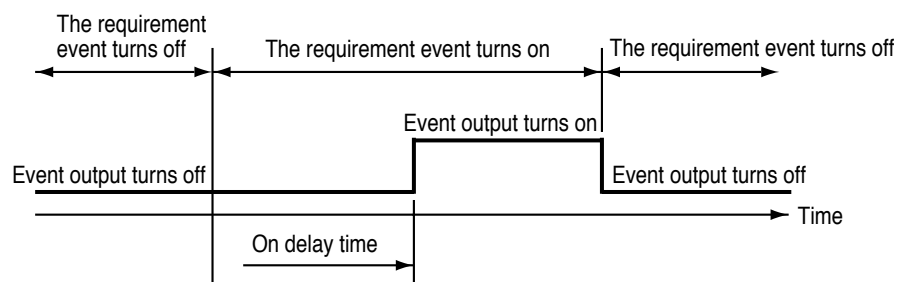

● **PA41 (EG1 LED display event number)**

The console EG1 LED lights when an event number set in **PA41** goes on and is off when it goes off. Note, however, that the EG1 LED is off when **PA41** is set to 0.

● **PA42 (EG2 LED display event number)**

The console EG2 LED lights when an event number set in **PA42** goes on and is off when it goes off. Note, however, that the EG2 LED is off when **PA42** is set to 0.

● **PA43 (PID computation initialize)**

When SP changes abruptly due to ADV, the derivative action of a PID computation, may cause an excessive change in the manipulated variable of the computation.

For this reason, the initialization of a PID computation is performed to suppress an excessive change.

But the initialization of a PID computation means that PID computation continuity is lost which may affect operating conditions. A **PA43** setting allows the user to turn on or off initialization and determine its conditions.

■ Event configuration data settings

No.	Item code	Item	Factory default settings	User settings	Settings and descriptions
1	E01-t	Event 1 event type	0		The event type setting of each event determines whether auxiliary setting 1 or auxiliary setting 2 is on or off, their meaning, unit and range. For details, see “■ Settings by event type” on the following pages.
2	E01-1	Event 1 auxiliary setting 1	----		
3	E01-2	Event 1 auxiliary setting 2	----		
4	E02-t	Event 2 event type	0		
5	E02-1	Event 2 auxiliary setting 1	----		
6	E02-2	Event 2 auxiliary setting 2	----		
7	E03-t	Event 3 event type	0		
8	E03-1	Event 3 auxiliary setting 1	----		
9	E03-2	Event 3 auxiliary setting 2	----		
10	E04-t	Event 4 event type	0		
11	E04-1	Event 4 auxiliary setting 1	----		
12	E04-2	Event 4 auxiliary setting 2	----		
13	E05-t	Event 5 event type	0		
14	E05-1	Event 5 auxiliary setting 1	----		
15	E05-2	Event 5 auxiliary setting 2	----		
16	E06-t	Event 6 event type	0		
17	E06-2	Event 6 auxiliary setting 1	----		
18	E06-3	Event 6 auxiliary setting 2	----		
19	E07-t	Event 7 event type	0		
20	E07-1	Event 7 auxiliary setting 1	----		
21	E07-2	Event 7 auxiliary setting 2	----		
22	E08-t	Event 8 event type	0		
23	E08-1	Event 8 auxiliary setting 1	----		
24	E08-2	Event 8 auxiliary setting 2	----		
25	E09-t	Event 9 event type	0		
26	E09-1	Event 9 auxiliary setting 1	----		
27	E09-2	Event 9 auxiliary setting 2	----		
28	E10-t	Event 10 event type	0		
29	E10-1	Event 10 auxiliary setting 1	----		
30	E10-2	Event 10 auxiliary setting 2	----		
31	E11-t	Event 11 event type	0		
32	E11-1	Event 11 auxiliary setting 1	----		
33	E11-2	Event 11 auxiliary setting 2	----		
34	E12-t	Event 12 event type	0		
35	E12-1	Event 12 auxiliary setting 1	----		
36	E12-2	Event 12 auxiliary setting 2	----		
37	E13-t	Event 13 event type	0		
38	E13-1	Event 13 auxiliary setting 1	----		
39	E13-2	Event 13 auxiliary setting 2	----		
40	E14-t	Event 14 event type	0		
41	E14-1	Event 14 auxiliary setting 1	----		
42	E14-2	Event 14 auxiliary setting 2	----		
43	E15-t	Event 15 event type	0		
44	E15-1	Event 15 auxiliary setting 1	----		
45	E15-2	Event 15 auxiliary setting 2	----		
46	E16-t	Event 16 event type	0		
47	E16-1	Event 16 auxiliary setting 1	----		
48	E16-2	Event 16 auxiliary setting 2	----		

■ Settings by event type

For information on event operations, see “■ Events” (pages 5-5 to 5-15).

Event type	0	1	2	3
Meaning Message	Event off OFF	Time event TIME	PV upper limit PV-H	PV lower limit PV-L
Range of auxiliary setting 1 Message	Unused	Unused	Hysteresis 0 to 1000 SPU hysteresis	Hysteresis 0 to 1000 SPU hysteresis
Range of auxiliary setting 2 Message	Unused	Unused	Unused	Unused
Setting category Operation category	– –	Segment type Time type	Segment type PV type	Segment type PV type

Event type	4	5	6	7
Meaning Message	Upper deviation limit DEV-H	Lower deviation limit DEV-L	Deviation rate upper limit wait DEV-H-W	Deviation lower limit with standby DEV-L-W
Range of auxiliary setting 1 Message	Hysteresis 0 to 1000 SPU hysteresis	Hysteresis 0 to 1000 SPU hysteresis	Hysteresis 0 to 1000 SPU hysteresis	Hysteresis 0 to 1000 SPU hysteresis
Range of auxiliary setting 2 Message	Unused	Unused	Unused	Unused
Setting category Operation category	Segment type PV type	Segment type PV type	Segment type PV type	Segment type PV type

Event type	8	9	10	11
Meaning Message	Absolute value deviation upper limit A-DEV-H	Absolute value deviation lower limit A-DEV-L	Absolute value deviation rate upper limit with standby A-DEV-H-W	Absolute value deviation lower limit with standby A-DEV-L-W
Range of auxiliary setting 1 Message	Hysteresis 0 to 1000 SPU hysteresis	Hysteresis 0 to 1000 SPU hysteresis	Hysteresis 0 to 1000 SPU hysteresis	Hysteresis 0 to 1000 SPU hysteresis
Range of auxiliary setting 2 Message	Unused	Unused	Unused	Unused
Setting category Operation category	Segment type PV type	Segment type PV type	Segment type PV type	Segment type PV type

Event type	12	13	14	15
Meaning Message	PV deviation rate upper limit A-DEV-H	PV deviation rate lower limit D-PV-L	SP upper limit SP-H	SP lower limit SP-L
Range of auxiliary setting 1 Message	Sampling cycle 0.1 to 600.0sec sampling rate	Sampling cycle 0.1 to 600.0sec sampling rate	Hysteresis 0 to 1000 SPU hysteresis	Hysteresis 0 to 1000 SPU hysteresis
Range of auxiliary setting 2 Message	Unused	Unused	Unused	Unused
Setting category Operation category	Segment type PV type	Segment type PV type	Segment type PV type	Segment type PV type

Event type	16	17	18	19
Meaning Message	MV upper limit MV-H	MV lower limit MV-L	Code event CODE	SOAK absolute value deviation upper limit S-A-DEV-H
Range of auxiliary setting 1 Message	Hysteresis 0.0 to 100.0% hysteresis	Hysteresis 0.0 to 100.0% hysteresis	Number of output points 1 to 8 *1 channels	Hysteresis 0 to 1000 SPU hysteresis
Range of auxiliary setting 2 Message	Unused	Unused	Unused	Unused
Setting category Operation category	Segment type PV type	Segment type PV type	Segment type Code type	Segment type PV type

*1: Code event auxiliary setting 1 (number of output points) can be changed only in the READY mode.

Event type	20	21	22	23
Meaning Message	SOAK absolute value deviation lower limit S-A-DEV-L	SOAK absolute value deviation upper limit with standby S-A-DEV-H-W	SOAK absolute value deviation lower limit with standby S-A-DEV-L-W	Timer code event T-CODE
Range of auxiliary setting 1 Message	Hysteresis 0 to 1000 SPU hysteresis	Hysteresis 0 to 1000 SPU hysteresis	Hysteresis 0 to 1000 SPU hysteresis	Number of output points 1 to 8 *2 channels
Range of auxiliary setting 2 Message	Unused	Unused	Unused	Unused
Setting category Operation category	Segment type PV type	Segment type PV type	Segment type PV type	Segment type Time type, code type

*2: Auxiliary setting 1 (number of output points) can be changed only in the READY mode.

Event type	24 to 63	64	65	66
Meaning Message	Event off OFF	Normal PV1 upper limit operation PV1-H	Normal PV1 lower limit operation PV1-L	Normal PV2 upper limit operation V2-H
Range of auxiliary setting 1 Message	Unused	Hysteresis 0 to 1000 SPU hysteresis	Hysteresis 0 to 1000 SPU hysteresis	Hysteresis 0 to 1000 SPU hysteresis
Range of auxiliary setting 2 Message	Unused	Operating point -19999 to +20000 SPU set point	Operating point -19999 to +20000 SPU set point	Operating point -19999 to +20000 SPU set point
Setting category Operation category	– –	Instrument type PV type	Instrument type PV type	Instrument type PV type

Event type	67	68	69	70
Meaning Message	Normal PV2 upper limit operation PV2-L	PV upper limit PV-H	PV lower limit PV-L	Deviation upper limit DEV-H
Range of auxiliary setting 1 Message	Hysteresis 0 to 1000 SPU hysteresis	Hysteresis 0 to 1000 SPU hysteresis	Hysteresis 0 to 1000 SPU hysteresis	Hysteresis 0 to 1000 SPU hysteresis
Range of auxiliary setting 2 Message	Operating point -19999 to +20000 SPU set point	Operating point -19999 to +20000 SPU set point	Operating point -19999 to +20000 SPU set point	Operating point -19999 to +20000 SPU set point
Setting category Operation category	Instrument type PV type	Instrument type PV type	Instrument type PV type	Instrument type PV type

Event type	71	72	73	74
Meaning Message	Deviation lower limit DEV-L	Deviation upper limit wait DEV-H-W	Deviation lower limit wait DEV-L-W	Absolute value deviation upper limit A-DEV-H
Range of auxiliary setting 1 Message	Hysteresis 0 to 1000 SPU hysteresis	Hysteresis 0 to 1000 SPU hysteresis	Hysteresis 0 to 1000 SPU hysteresis	Hysteresis 0 to 1000 SPU hysteresis
Range of auxiliary setting 2 Message	Operating point -19999 to +20000 SPU set point	Operating point -19999 to +20000 SPU set point	Operating point -19999 to +20000 SPU set point	Operating point 0 to 20000 SPU set point
Setting category Operation category	Instrument type PV type	Instrument type PV type	Instrument type PV type	Instrument type PV type

Event type	75	76	77	78
Meaning Message	Absolute value deviation lower limit A-DEV-L	Absolute value deviation upper limit with standby A-DEV-H-W	Absolute value deviation lower limit with standby A-DEV-L-W	PV deviation rate upper limit D-PV-H
Range of auxiliary setting 1 Message	Hysteresis 0 to 1000 SPU hysteresis	Hysteresis 0 to 1000 SPU hysteresis	Hysteresis 0 to 1000 SPU hysteresis	Sampling cycle 0.1 to 600.0 sec sampling rate
Range of auxiliary setting 2 Message	Operating point 0 to 20000 SPU set point	Operating point 0 to 20000 SPU set point	Operating point 0 to 20000 SPU set point	Operating point -19999 to +20000 SPU set point
Setting category Operation category	Instrument type PV type	Instrument type PV type	Instrument type PV type	Instrument type PV type

Event type	79	80	81	82
Meaning Message	PV deviation rate lower limit D-PV-L	SP upper limit SP-H	SP lower limit SP-L	MV upper limit MV-H
Range of auxiliary setting 1 Message	Sampling cycle 0.1 to 600.0sec sampling rate	Hysteresis 0 to 1000 SPU hysteresis	Hysteresis 0 to 1000 SPU hysteresis	Hysteresis 0.0 to 100.0% hysteresis
Range of auxiliary setting 2 Message	Operating point -19999 to +20000 SPU set point	Operating point -19999 to +20000 SPU set point	Operating point -19999 to +20000 SPU set point	Operating point -5.0 to +105.0% set point
Setting category Operation category	Instrument type PV type	Instrument type PV type	Instrument type PV type	Instrument type PV type

Event type	83	84	85	86
Meaning Message	MV lower limit MV-L	SOAK absolute value deviation upper limit S-A-DEV-H	SOAK absolute value deviation lower limit S-A-DEV-L	SOAK absolute value deviation upper limit with standby S-A-DEV-H-W
Range of auxiliary setting 1 Message	Hysteresis 0.0 to 100.0% hysteresis	Hysteresis 0 to 1000 SPU hysteresis	Hysteresis 0 to 1000 SPU hysteresis	Hysteresis 0 to 1000 SPU hysteresis
Range of auxiliary setting 2 Message	Operating point -5.0 to +105.0% set point	Operating point 0 to 20000 SPU set point	Operating point 0 to 20000 SPU set point	Operating point 0 to 20000 SPU set point
Setting category Operation category	Instrument type PV type	Instrument type PV type	Instrument type PV type	Instrument type PV type

Event type	87	88	89	90
Meaning Message	SOAK absolute value deviation lower limit with standby S-A-DEV-L-W	Program number binary code PROG-BIN	Segment number binary code SEG-BIN	Program number BCD code PROG-BCD
Range of auxiliary setting 1 Message	Hysteresis 0 to 1000 SPU hysteresis	Number of output points 1 to 7 channels	Number of output points 1 to 7 channels	Number of output points 1 to 8 channels
Range of auxiliary setting 2 Message	Operating point 0 to 20000 SPU set point	Unused	Unused	Unused
Setting category Operation category	Instrument type PV type	Instrument type Code type	Instrument type Code type	Instrument type Code type

Event type	91	92	93	94
Meaning	Segment number BCD code	Special segment	RAMP-E time monitoring	Segment time
Message	SEG-BCD	SEG SEQUENCE	RAMP-E TIME OUT	SEG TIME
Range of auxiliary setting 1	Number of output points 1 to 8	Segment specification -2 to +2 *1	Operating point 0.0 to 3000.0sec *2	On Time 0:00 to 500:00 *3
Message	channels	segment	time out	on-time
Range of auxiliary setting 2	Unused	Unused	Unused	Off Time 0:00 to 500:00 *3
Message				off-time
Setting category	Instrument type	Instrument type	Instrument type	Instrument type
Operation category	Code type	Mode type	Time type	Time type

Event type	95	96	97	98
Meaning	Program time	PV1-PV2 differential upper limit during CH switching	PV1-PV2 differential lower limit during CH switching	PV1-PV2 differential upper limit
Message	PROG TIME	CHG. P-CH-DEV-H	CHG. P-CH-DEV-L	CH-DEV-H
Range of auxiliary setting 1	On Time 0:00 to 500:00 *3	Unused	Unused	Hysteresis 0 to 1000 SPU
Message	on-time			hysteresis
Range of auxiliary setting 2	Off Time 0:00 to 500:00 *3	Operating point -19999 to +20000 SPU	Operating point -19999 to +20000 SPU	Operating point -19999 to +20000 SPU
Message	off-time	set point	set point	set point
Setting category	Instrument type	Instrument type	Instrument type	Instrument type
Operation category	Time type	PV type	PV type	PV type

*1: The meaning of auxiliary setting 1 for special segment is shown below.

- 2: Two segments before the final segment 1: First segment
-1: One segment before the final segment 2: Second segment
0: Final segment

*2: When auxiliary setting 1 of RAMP-E time monitoring is set to 0.0 sec, event output is off.

*3: Auxiliary setting 1 and auxiliary setting 2 of segment time and program time that determine display unit and range of segment are set by setup data **C62** settings as follows.

When **C62** is set to 0: 0 hours 00 min to 500 hours 00 min

When **C62** is set to 1: 0 min 00 sec to 500 min 00 sec

When **C62** is set to 2: 0.0 sec to 3000.0 sec

Event type	99	100 to 127	128	129
Meaning	PV1-PV2 differential lower limit	Event off	RUN, HOLD, END, FAST	HOLD
Message	CH-DEV-L	OFF	RUN,HOLD, END, FAST	HOLD
Range of auxiliary setting 1	Hysteresis 0 to 1000 SPU	Unused	Unused	Unused
Message	hysteresis			
Range of auxiliary setting 2	Operating point -19999 to +20000 SPU	Unused	Unused	Unused
Message	set point			
Setting category	Instrument type	-	Instrument type	Instrument type
Operation category	PV type	-	Mode type	Mode type

Event type	130	131	132	133
Meaning Message	READY, READY FAST READY, READY FAST	END END	G.SOAK wait G.SOAK	MANUAL MANUAL
Range of auxiliary setting 1	Unused	Unused	Unused	Unused
Range of auxiliary setting 2 Message	Unused	Unused	Unused	Unused
Setting category Operation category	Instrument type Mode type	Instrument type Mode type	Instrument type Mode type	Instrument type Mode type

Event type	134	135	136	137
Meaning Message	AT executing AT	FAST, READY FAST FAST, READY FAST	Console settings are being made CONSOLE	RUN RUN
Range of auxiliary setting 1	Unused	Unused	Unused	Unused
Range of auxiliary setting 2 Message	Unused	Unused	Unused	Unused
Setting category Operation category	Instrument type Mode type	Instrument type Mode type	Instrument type Mode type	Instrument type Mode type

Event type	138	139	140	141
Meaning Message	Advance ADV	All alarm (logical OR) ALL ALARMS	PV range alarm PV ALARMS	DCP551 alarm DCP ALARMS
Range of auxiliary setting 1	Unused	Unused	Unused	Unused
Range of auxiliary setting 2 Message	Unused	Unused	Unused	Unused
Setting category Operation category	Instrument type Mode type	Instrument type Mode type	Instrument type Mode type	Instrument type Mode type

Event type	142	143	144	145 to 253
Meaning Message	PV1 selected SELECT PV1	PV2 selected SELECT PV2	Battery voltage drop BATTERY LOW	Event off OFF
Range of auxiliary setting 1	Unused	Unused	Unused	Unused
Range of auxiliary setting 2 Message	Unused	Unused	Unused	Unused
Setting category Operation category	Instrument type Mode type	Instrument type Mode type	Instrument type Mode type	- -

■ PID parameter setting

No.	Item code	Item	Factory default settings	User settings	Settings and descriptions
1	<i>P-1</i>	Proportional band (PID group 1)	100.0		<p><i>P</i> : 0.0 to 1000.0% ON-OFF control when set to 0.0</p> <p><i>I</i> : 0 to 3600sec No integral operation when set to 0</p> <p><i>d</i> : 0 to 1200sec No derivative operation when set to 0</p> <p><i>rE</i> : 0.0 to 100.0%</p> <p><i>oL</i> : -5.0 to manipulated variable upper limit %</p> <p><i>oH</i> : Manipulated variable lower limit to +105.0%</p> <p><i>CP</i> : -19999 to +20000 SPU</p> <p><i>tP</i> : -19999 to +20000 SPU</p> <p>[Description:]</p> <ul style="list-style-type: none"> When <i>P</i> is set to 0.0, ON-OFF control is on and <i>I</i>, <i>d</i> and <i>rE</i> settings display "-----" and setting cannot be performed. When the <i>I</i> setting is not equal to 0, "-----" is displayed for <i>rE</i> and setting cannot be performed. Although a low <i>P</i> setting improves control, overshoot and hunting is more likely to occur. Although a low <i>I</i> setting improves tracking, cycling caused by integral operation occurs more often. Although a low <i>d</i> setting makes it easier to suppress overshoot, hunting is more likely to occur due to reactions to minute PV action. In normal temperature control, derivative time should be between 1/3 to 1/4 of the integral time. Since derivative operation is a cause of hunting in pressure and flow control, set <i>d</i> to 0.0 to turn off derivative action or set a low value. The <i>rE</i> setting is used to eliminate offset caused by proportional action (no integral action) and sets a suitable deviation of 0. The <i>oL</i> and <i>oH</i> settings also operate as integral limiters. When <i>oL</i> or <i>oH</i> manipulated variable reaches the upper or lower limit, they turn off integral action and prevents reset windup that occurs when PV has not risen for a long time. The <i>CP</i> setting is the point where switching occurs between PID groups A1 to A7. <i>tP</i> is the tuning point where <i>P</i>, <i>I</i> and <i>D</i> settings in groups A1 to A7 are automatically tuned starting from A1.
2	<i>I-1</i>	Integral time (PID group 1)	0		
3	<i>d-1</i>	Derivative time (PID group 1)	0		
4	<i>rE-1</i>	Manual reset (PID group 1)	50.0		
5	<i>oL-1</i>	Manipulated variable lower limit (Output limiter group 1)	0.0		
6	<i>oH-1</i>	Manipulated variable upper limit (Output limiter group 1)	100.0		
7	<i>P-2</i>	Proportional band (PID group 2)	100.0		
8	<i>I-2</i>	Integral time (PID group 2)	0		
9	<i>d-2</i>	Derivative time (PID group 2)	0		
10	<i>rE-2</i>	Manual reset (PID group 2)	50.0		
11	<i>oL-2</i>	Manipulated variable lower limit (Output limiter group 2)	0.0		
12	<i>oH-2</i>	Manipulated variable upper limit (Output limiter group 2)	100.0		
13	<i>P-3</i>	Proportional band (PID group 3)	100.0		
14	<i>I-3</i>	Integral time (PID group 3)	0		
15	<i>d-3</i>	Derivative time (PID group 3)	0		
16	<i>rE-3</i>	Manual reset (PID group 3)	50.0		
17	<i>oL-3</i>	Manipulated variable lower limit (Output limiter group 3)	0.0		
18	<i>oH-3</i>	Manipulated variable upper limit (Output limiter group 3)	100.0		
19	<i>P-4</i>	Proportional band (PID group 4)	100.0		
20	<i>I-4</i>	Integral time (PID group 4)	0		
21	<i>d-4</i>	Derivative time (PID group 4)	0		
22	<i>rE-4</i>	Manual reset (PID group 4)	50.0		
23	<i>oL-4</i>	Manipulated variable lower limit (Output limiter group 4)	0.0		
24	<i>oH-4</i>	Manipulated variable upper limit (Output limiter group 4)	100.0		
25	<i>P-5</i>	Proportional band (PID group 5)	100.0		
26	<i>I-5</i>	Integral time (PID group 5)	0		
27	<i>d-5</i>	Derivative time (PID group 5)	0		
28	<i>rE-5</i>	Manual reset (PID group 5)	50.0		
29	<i>oL-5</i>	Manipulated variable lower limit (Output limiter group 5)	0.0		
30	<i>oH-5</i>	Manipulated variable upper limit (Output limiter group 5)	100.0		
31	<i>P-6</i>	Proportional band (PID group 6)	100.0		
32	<i>I-6</i>	Integral time (PID group 6)	0		
33	<i>d-6</i>	Derivative time (PID group 6)	0		

No.	Item code	Item	Factory default settings	User settings	Settings and descriptions
34	rE-6	Manual reset (PID group 6)	50.0		
35	oL-6	Manipulated variable lower limit (Output limiter group 6)	0.0		
36	oH-6	Manipulated variable upper limit (Output limiter group 6)	100.0		
37	P-7	Proportional band (PID group 7)	100.0		
38	I-7	Integral time (PID group 7)	0		
39	d-7	Derivative time (PID group 7)	0		
40	rE-7	Manual reset (PID group 7)	50.0		
41	oL-7	Manipulated variable lower limit (Output limiter group 7)	0.0		
42	oH-7	Manipulated variable upper limit (Output limiter group 7)	100.0		
43	P-8	Proportional band (PID group 8)	100.0		
44	I-8	Integral time (PID group 8)	0		
45	d-8	Derivative time (PID group 8)	0		
46	rE-8	Manual reset (PID group 8)	50.0		
47	oL-8	Manipulated variable lower limit (Output limiter group 8)	0.0		
48	oH-8	Manipulated variable upper limit (Output limiter group 8)	100.0		
49	P-9	Proportional band (PID group 9)	100.0		
50	I-9	Integral time (PID group 9)	0		
51	d-9	Derivative time (PID group 9)	0		
52	rE-9	Manual reset (PID group 9)	50.0		
53	oL-9	Manipulated variable lower limit (Output limiter group 9)	0.0		
54	oH-9	Manipulated variable upper limit (Output limiter group 9)	100.0		
55	P-A1	Proportional band (PID group A1)	100.0		
56	I-A1	Integral time (PID group A1)	0		
57	d-A1	Derivative time (PID group A1)	0		
58	rE-A1	Manual reset (PID group A1)	50.0		
59	CP-A1	Changeover point (PID group A1)	1000 SPU		
60	tP-A1	Tuning point (PID group A1)	500 SPU		
61	P-A2	Proportional band (PID group A2)	100.0		
62	I-A2	Integral time (PID group A2)	0		
63	d-A2	Derivative time (PID group A2)	0		
64	rE-A2	Manual reset (PID group A2)	50.0		
65	CP-A2	Changeover point (PID group A2)	2000 SPU		
66	tP-A2	Tuning point (PID group A2)	1500 SPU		
67	P-A3	Proportional band (PID group A3)	100.0		
68	I-A3	Integral time (PID group A3)	0		
69	d-A3	Derivative time (PID group A3)	0		
70	rE-A3	Manual reset (PID group A3)	50.0		
71	CP-A3	Changeover point (PID group A3)	3000 SPU		
72	tP-A3	Tuning point (PID group A3)	2500 SPU		
73	P-A4	Proportional band (PID group A4)	100.0		
74	I-A4	Integral time (PID group A4)	0		
75	d-A4	Derivative time (PID group A4)	0		
76	rE-A4	Manual reset (PID group A4)	50.0		
77	CP-A4	Changeover point (PID group A4)	4000 SPU		
78	tP-A4	Tuning point (PID group A4)	3500 SPU		
79	P-A5	Proportional band (PID group A5)	100.0		
80	I-A5	Integral time (PID group A5)	0		

No.	Item code	Item	Factory default settings	User settings	Settings and descriptions
81	d-A5	Derivative time (PID group A5)	0		
82	rE-A5	Manual reset (PID group A5)	50.0		
83	CP-A5	Changeover point (PID group A5)	5000 SPU		
84	tP-A5	Tuning point (PID group A5)	4500 SPU		
85	P-A6	Proportional band (PID group A6)	100.0		
86	I-A6	Integral time (PID group A6)	0		
87	d-A6	Derivative time (PID group A6)	0		
88	rE-A6	Manual reset (PID group A6)	50.0		
89	CP-A6	Changeover point (PID group A6)	6000 SPU		
90	tP-A6	Tuning point (PID group A6)	5500 SPU		
91	P-A7	Proportional band (PID group A7)	100.0		
92	I-A7	Integral time (PID group A7)	0		
93	d-A7	Derivative time (PID group A7)	0		
94	rE-A7	Manual reset (PID group A7)	50.0		
95	CP-A7	Changeover point (PID group A7)	20000 SPU (fixed)		
96	tP-A7	Tuning point (PID group A7)	6500 SPU		

■ Setup data setting

No.	Item code	Item	Factory default settings	User settings	Settings and descriptions
1	C 01	PV1 range number	0		0 to 16 : t/c 48 to 52 : linear (DC current, DC voltage) 64 to 71 : RTD 96 to 103 : RTD 128 to 134: linear (DC current, DC voltage) [Description:] For details see range numbers listed in "Section 2-3 Input Type and Range Number" (page 2-8)
2	C 02	PV1 temperature unit	0		0: °C Celsius 1: °F Fahrenheit [Description:] When setting C01 is linear, "-----" is displayed and setting cannot be performed.
3	C 03	PV1 decimal point position	1		0 to 2 A setting of 0 means no decimal point and a setting of 1 and 2 indicates the number of decimal digits. [Description:] When setting C01 is linear, "-----" is displayed and setting cannot be performed. The setting range varies with the C01 and C02 setting. • A setting between 0 and 2 can be made when C01 is set to: 5, 15, 65 to 69, 97 to 101 and C02 is set to 0. C01 settings: 66, 68, 69, 98, 100, 101 and C02 is set to 1. • A setting of 0 and 1 can be made when C01 is set to: 0 to 4, 6 to 14, 16, 64, 70, 71, 96, 102, 103 and C02 is set to 0. C01 settings: 0 to 5, 7, 8, 10, 12 to 14, 16, 64, 65, 67, 70, 71, 96, 97, 99, 102, 103 and C02 is set to 1. • Only a setting of 0 is possible when C01 is set to: 6, 9, 11 and C02 is set to 1 When the C01 setting is for a t/c or RTD, this setting is reflected in PVU (PV1) units.
4	C 04	PV1 linear decimal point position	1		0 to 4 A setting of 0 means no decimal point and a setting between 1 and 4 indicates the number of decimal digits. [Description:] C01 settings for t/c and RTD display "-----" and setting cannot be performed. When setting C01 is linear, this setting is reflected in PVU (PV1) units.
5	C 05	PV1 linear range lower limit	0 PVU		-19999 to +20000 PVU (PV1) [Description:] C01 settings for t/c and RTD display "-----" and setting cannot be performed.
6	C 06	PV1 linear range upper limit	10000PVU		Reversing the lower limit and upper limit makes it possible to reverse analog inputs and specified values.
7	C 07	PV1 cold junction compensation	0		0: Provided (compensated internally) 1: Not provided (compensated externally) [Description:] C01 settings for t/c and RTD display "-----" and setting cannot be performed.
8	C 08	PV1 square root extraction	0		0: Not provided 1: Provided [Description:] C01 settings for t/c and RTD display "-----" and setting cannot be performed.
9	C 09	PV1 square root extraction dropout	0.2		0.2 to 10.0% (ratio depends on input range) [Description:] C01 settings for t/c and RTD display "-----" and setting cannot be performed.
10	C 10	PV1 cold junction bias	0.0		-1.0 to +1.0°C [Description:] C01 settings for t/c and RTD display "-----" and setting cannot be performed. Use 0.0 for normal settings.

No.	Item code	Item	Factory default settings	User settings	Settings and descriptions
11	C 11	PV2 range number	0		0 to 16 : t/c 48 to 52 : linear (DC current, DC voltage) 64 to 71 : RTD 96 to 103 : RTD 128 to 134: linear (DC current, DC voltage) [Description:] For details see range numbers listed in “Section 2-3 Input Type and Range Number” (page 2-8).
12	C 12	PV2 temperature unit	0		0: °C Celsius 1: °F Fahrenheit [Description:] When setting C11 is linear, “-----” is displayed and setting cannot be performed.
13	C 13	PV2 decimal point position	1		0 to 2 A setting of 0 means no decimal point and a setting of 1 and 2 indicates the number of decimal digits. [Description:] When setting C11 is linear, “-----” is displayed and setting cannot be performed. The setting range varies with the C11 and C12 setting. • A setting between 0 and 2 can be made when C11 is set to: 5, 15, 65 to 69, 97 to 101 and C12 is set to 0. C11 settings: 66, 68, 69, 98, 100, 101 and C12 is set to 1. • A setting of 0 and 1 can be made when C11 is set to: 0 to 5, 7, 8, 10, 12 to 14, 16, 64, 65, 67, 70, 71, 96, 97, 102, 103 and C12 is set to 1. • Only a setting of 0 is possible when C11 is set to: 6, 9, 11 and C12 is set to 1. • When the C11 setting is for t/c or RTD, this setting is reflected in PVU (PV2) units.
14	C 14	PV2 linear decimal point position	1		0 to 4 A setting of 0 means no decimal point and a setting between 1 and 4 indicates the number of decimal digits. [Description:] C11 settings for t/c and RTD display “-----” and setting cannot be performed. When setting C11 is linear, this setting is reflected in PVU (PV2) units.
15	C 15	PV2 linear range lower limit	0 PVU		–19999 to +20000 PVU (PV2) [Description:] C11 settings for t/c and RTD display “-----” and setting cannot be performed.
16	C 16	PV2 linear range upper limit	10000PVU		Reversing the lower limit and upper limit makes it possible to reverse analog inputs and specified values.
17	C 17	PV2 cold junction compensation	0		0: Yes (compensated internally) 1: No (compensated externally) [Description:] C11 settings for t/c and RTD display “-----” and setting cannot be performed.
18	C 18	PV2 square root extraction	0		0: No 1: Yes [Description:] C11 settings for t/c and RTD display “-----” and setting cannot be performed.
19	C 19	PV2 square root extraction dropout	0.2		0.2 to 10.0 % (ratio depends on input range) [Description:] C11 settings for t/c and RTD display “-----” and setting cannot be performed.
20	C 20	PV2 cold junction bias	0.0		–1.0 to +1.0 °C [Description:] C11 settings for t/c and RTD display “-----” and setting cannot be performed. Use 0.0 for normal settings.

From C11 to C20 “-----” is displayed and setting cannot be performed on model with one PV input channel.

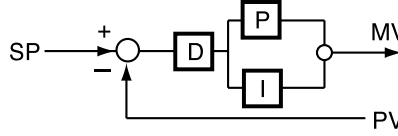
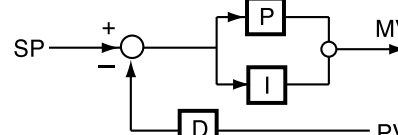
No.	Item code	Item	Factory default settings	User settings	Settings and descriptions
21	C 21	Control output system	1		<p>0 : 5S output (current proportional SP output) 1 : 5G output (current proportional control output) 2 : 6D output (voltage time proportional control output) system A 3 : 6D output (voltage time proportional control output) system B 4 : 8D output (open collector time proportional control output) system A 5 : 8D output (open collector time proportional control output) system B</p> <p>[Description:] The difference between system A and system B is in the output system of ON-OFF control and auto-tuning. System A: Output ON-OFF is performed regardless of time proportional output cycles and output limits. System B: The output limit upper limit value is output instead of on and the output limit lower value is output instead of off according to time proportional output cycles.</p>
22	C 22	Unused	----		<p>[Description:] "----" is displayed and setting cannot be performed.</p>
23	C 23	Control operation	0		<p>0: PID-A reverse operation 1: PID-A normal operation 2: PID-B reverse operation 3: PID-B normal operation</p> <p>[Description:] PID-A: deviation derivative PID (system where SP changes are affected by derivative action)</p>  <p>PID-B: derivative-based PID (system where SP changes are not affected by derivative action)</p> 
24	C 24	Unused	----		
25	C 25	PV channel switching type	0		<p>0: PV1 low-temperature sensor, PV2 high-temperature sensor 1: PV1 high-temperature sensor, PV2 low-temperature sensor 2: PV1 tied 3: PV2 tied 4: Backup switching</p> <p>[Description:] "----" is displayed and setting cannot be performed on model with one PV input channel.</p>
26	C 26	PV channel switching system	0		<p>0: External switch switching 1: Automatic switching A (switching + dead band) 2: Automatic switching B (switching + dead band + external switch) 3: Automatic switching C (2-point proportional)</p> <p>[Description:] "----" is displayed and setting cannot be performed on model with one PV input channel. When C25 is set to more than 1, "----" is displayed and setting cannot be performed.</p>
27	C 27	PV channel switching point	10000PVU		<p>-19999 to +20000 PVU (PV1)</p> <p>[Description:] "----" is displayed and setting cannot be performed on model with one PV input channel. When C25 is set to more than 1, "----" is displayed and setting cannot be performed. When C26 is set 0, "----" is displayed and setting cannot be</p>

No.	Item code	Item	Factory default settings	User settings	Settings and descriptions
28	C 28	PV channel switching dead band	100 PVU		1 to 1000 PVU (PV1) [Description:] "-----" is displayed and setting cannot be performed on model with one PV input channel. When C25 is set to more than 1, "-----" is displayed and setting cannot be performed. When C26 is set 0, "-----" is displayed and setting cannot be performed.
29	C 29	Selections available when power is on during PV channel switching	0		0: Continues until power is turned off 1: PV1 2: PV2 3: High-temperature PV 4: Low-temperature PV [Description:] "-----" is displayed and setting cannot be performed on model with one PV input channel. When C25 is set to more than 1, "-----" is displayed and setting cannot be performed. When C26 is set 0, "-----" is displayed and setting cannot be performed.
30	C 30	PV equalizer	0		0: No 1: PV1 only 2: PV2 only 3: PV1 and PV2 [Description:] The range of settings is 0 to 1 on model with one PV input channel.
31	C 31	End of operation	0		0: READY mode 1: END mode
32	C 32	Manipulated variable in READY mode	0.0		-5.0 to +105.0 %
33	C 33	Manipulated variable setting in PV overrange	0		0: No 1: Yes
34	C 34	Manipulated variable in PV overrange	0.0		-5.0 to +105.0 %
35	C 35	Manual change mode	0		0: smooth 1: preset [Description:] When C21 is set to 0, the output is smooth regardless of setting.
36	C 36	Preset MANUAL value	0.0		-5.0 to +105.0 %
37	C 37	Unused	----		[Description:]
38	C 38	Unused	----		"-----" is displayed and setting cannot be performed.
39	C 39	Unused	----		
40	C 40	Unused	----		
41	C 41	Unused	----		
42	C 42	Unused	----		
43	C 43	Length of outage permitting continuous operation	0		0 to 3600sec When set to 0, operation continues regardless of outage time. [Description:] The HOLD mode is invoked when the outage is longer than set time. The measurement of a power outage may vary by about 10 seconds.
44	C 44	Unused	----		[Description:] "-----" is displayed and setting cannot be performed.
45	C 45	Auxiliary output 1 type	0		0: SP 1: PV 2: Deviation (DEV) 3: Manipulated variable (MV) 4: PV1 5: PV2 [Description:] "-----" is displayed and setting cannot be performed on model without auxiliary output.
46	C 46	Auxiliary output 1 lower limit (4mA)	0 SPU		-19999 to +20000 SPU (C45 not equal to 3) -1999.9 to +2000.0 SPU (C45 set to 3) [Description:]
47	C 47	Auxiliary output 1 upper limit (20mA)	10000SPU		"-----" is displayed and setting cannot be performed on model without auxiliary output.

No.	Item code	Item	Factory default settings	User settings	Settings and descriptions
48	C 48	Auxiliary output 2 type	0		0: SP 1: PV 2: Deviation (DEV) 3: Manipulated variable (MV) 4: PV1 5: PV2 [Description:] "-----" is displayed and setting cannot be performed on model without auxiliary output or with one auxiliary output.
49	C 49	Auxiliary output lower limit (4mA)	0 SPU		-19999 to +20000 SPU (C48 not equal to 3) -1999.9 to +2000.0% (C48 set to 3) [Description:] "-----" is displayed and setting cannot be performed on model without auxiliary output or with one auxiliary output.
50	C 50	Auxiliary output upper limit (20mA)	10000SPU		[Description:] "-----" is displayed and setting cannot be performed.
51	C 51	Unused	----		[Description:] "-----" is displayed and setting cannot be performed.
52	C 52	SP output lower limit (4mA)	0 SPU		-19999 to +20000 SPU [Description:] "-----" is displayed and setting cannot be performed when C21 is not equal to 0.
53	C 53	SP output upper limit (20mA)	10000SPU		[Description:] "-----" is displayed and setting cannot be performed.
54	C 54	Unused	----		[Description:] "-----" is displayed and setting cannot be performed.
55	C 55	Unused	----		
56	C 56	Unused	----		
57	C 57	Programming item event	0		0: Displayed 1: Not displayed
58	C 58	Programming item PID group, output limiter group	0		0: Displayed 1: Not displayed
59	C 59	Programming item G.SOAK, PV shift, repeat	0		0: Displayed 1: Not displayed
60	C 60	Programming item PV start, cycle, pattern link	0		0: Displayed 1: Not displayed
61	C 61	Programming system	0		0: RAMP-X and RAMP-T (θ) combined 1: RAMP-X and RAMP-E (ΔSP) combined
62	C 62	Programming time unit	0		0: hours, min (SPU/hour for RAMP-T) 0: min, sec (SPU/min for RAMP-T) 0: 0.1 sec (SPU/sec for RAMP-T)
63	C 63	Time display (display panel 2)	0		0: remaining segment time 1: total operation time (after READY → RUN start)
64	C 64	Unused	----		[Description:] "-----" is displayed and setting cannot be performed.
65	C 65	SP decimal point position	1		0 to 4 A setting of 0 means no decimal point and a setting between 1 and 4 indicates the number of decimal digits. [Description:] This setting is reflected in "PVU (SPU)" units.
66	C 66	SP limit lower limit	PV1 range lower limit		-19999 to +20000 SPU [Description:] When C01 to C06 are set, C66 and C67 are automatically set as the upper limit and lower limit of the range.
67	C 67	SP limit upper limit	PV1 range upper limit		[Description:] "-----" is displayed and setting cannot be performed.
68	C 68	Unused	----		[Description:] "-----" is displayed and setting cannot be performed.
69	C 69	Unused	----		
70	C 70	Unused	----		

No.	Item code	Item	Factory default settings	User settings	Settings and descriptions
71	C 71	External switch input RSW5	0		0 : NOP (does not function) 1 : RAMP-E 2 : FAST 3 : G.SOAK is cleared using OR 4 : G.SOAK is cleared using AND 5 : MANUAL/AUTO 6 : AT start/terminate 7 : PV1/PV2 8 : Auto load 9 : PV1 → PV2 wait 10: PV2 → PV1 wait 11: NOP (does not function) 12: Normal operation/reverse operation
72	C 72	External switch input RSW6	0		
73	C 73	External switch input RSW7	0		
74	C 74	External switch input RSW8	0		
75	C 75	External switch input RSW9 to 16 (program selection)	0		0: BCD4 bit x 2 digits 1: binary 7 bits
76	C 76	Communication address	0		0 to 127 [Description:] "----" is displayed and setting cannot be performed on model without communications. When C76 is set to 0, the communication function is not activated.
77	C 77	Transmission rate	0		0: 9600bps 1: 4800bps 2: 2400bps 3: 1200bps [Description:] "----" is displayed and setting cannot be performed on model without communications.
78	C 78	Transmission code	0		0: 8 bits, even parity, 1 stop bit 1: 8 bits, no parity, 2 stop bits [Description:] "----" is displayed and setting cannot be performed on model without communications.
79	C 79	Communication	0		0: CPL 1: ST221 (no PV trend) 2: ST221 (PV trend) [Description:] "----" is displayed and setting cannot be performed on model without communications.
80	C 80	Communication method	0		0 : RS-485 1 : RS-232C [Description:] "----" is displayed and setting cannot be performed on model without communications.
81	C 81	ROM ID	—		[Description:]
82	C 82	ROM ITEM	—		Can only be referenced for mechanical service use.
83	C 83	ROM revision	—		
84	C 84	Data version	—		
85	C 85	CPU board ID	—		
86	C 86	I/O board ID	—		
87	C 87	Unused	----		[Description:]
88	C 88	Unused	----		"----" is displayed and setting cannot be performed.
89	C 89	Unused	----		
90	C 90	PID type	1		0: Improved 1: Compatible with Mark I
91	C 91	PV1 burnout	0		0: Yes 1: No
92	C 92	PV2 burn out	0		0: Yes 1: No [Description:] "----" is displayed and setting cannot be performed on model with one PV input channel.
93	C 93	Time proportional output system	0		0: Does not go on a second time off in time proportional cycle. 1: Goes on a second time in time proportional cycle.
94	C 94	Unused	----		[Description:] "----" is displayed and setting cannot be performed.

No.	Item code	Item	Factory default settings	User settings	Settings and descriptions
95	C 95	Voltage output control	15		2 to 22mA
96	C 96	Unused	----		[Description:] “-----” is displayed and setting cannot be performed.
97	C 97	Communications port	0		0 to 15 The backplate terminal is used when set to 0. The loader jack is used for settings 1 to 15. [Description:] When set to 0, communications cannot be performed on model without communications. When set to 0, communications conditions are selected using C76 to C80. The communication address is used for settings 1 to 15. 4800bps, 8 bits, even parity, 1 stop bit
98	C 98	Special function	0		0 to 255 [Description:] A setting of 0 is normally used.
99	C 99	PV1 zener barrier adjustment	----		-20.00 to +20.00 [Description:] “-----” is displayed and setting cannot be performed when PV1 is not RTD or C98 is not equal to 241.
100	C100	PV2 zener barrier adjustment	----		-20.00 to +20.00 [Description:] “-----” is displayed and setting cannot be performed when PV2 is not RTD or C98 is not equal to 241.

■ Detailed descriptions of setup data settings

● **C07 (PV1 cold junction compensation)**

● **C17 (PV2 cold junction compensation)**

- This is a selection for cold junction compensation for thermocouples.
- When set to 1, perform 0°C compensation using a cold junction compensation device outside the DCP551

● **C08 (PV1 square root extraction)**

● **C09 (PV1 square root extraction dropout)**

● **C18 (PV2 square root extraction)**

● **C19 (PV2 square root extraction dropout)**

- Flow pressure detected by the orifice of a normal differential pressure type flowmeter is proportional to the power 2 of the flow rate signal. Consequently, square root extraction is used when a uniform signal is needed.
- When the input in the square root extraction is **C09** or less than the dropout set in **C19**, an output of 0% can be obtained in the square root process.
- Square root extraction is not performed when **C08** and **C18** are set to 0.

Output of root extraction (Y)

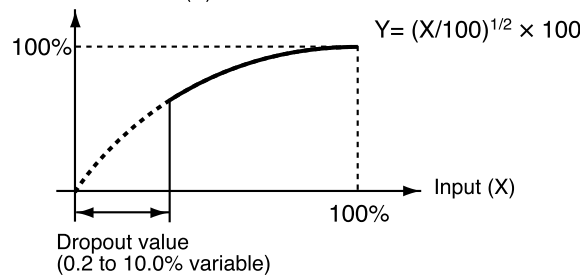

● **C46 (auxiliary output 1 lower limit)**

● **C47 (auxiliary output 1 upper limit)**

● **C49 (auxiliary output 2 lower limit)**

● **C50 (auxiliary output 2 upper limit)**

- This is the scaling setting of the auxiliary output. The high and low values for the upper and lower limits can be reversed.
- The example below shows that the output from auxiliary output 1 is 12mA when MV is 100% and 20mA when MV is 0%. As shown, a 200% MV value is required to generate an output of 4mA.

Thus **C46** is set to 200.0 and **C47** is set to 0.0.

Auxiliary output 1

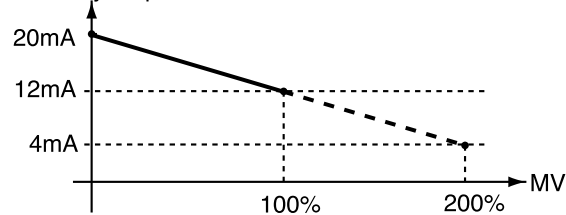

● **C52 (SP output lower limit)**

● **C53 (SP output upper limit)**

These are scaling settings of SP output. The high and low values for the upper and lower limits can be reversed.

● **C63 (time display)**

0: remaining segment time

1: total operation time

- These are selections for display panel 2 in the normal display mode in the program run mode.
- In the READY mode a setting of 0 displays the set time values for the selected segments.
- In the RUN, HOLD, FAST and END modes a setting of 0 displays the remaining time in rounded hours.

For example, when the time unit hours/min is selected a remaining time of 1 hour 30 minutes and 59 seconds is displayed as “**1.30**”.

- In the READY mode a setting of 1 displays the time as “**0.00**”.
- In the RUN, HOLD, FAST and END modes a setting of 1 means that the time is displayed in rounded hours after a change from the READY mode to the RUN mode. In G.SOAK wait, repeat, cycle and pattern link, time is displayed as integrated values. When the time unit is hours/min or min/sec, the display returns to “**0.00**” after “**499.59**”. When the time unit is 0.1 sec, the display returns to “**0.0**” after “**2999.9**”.

When the time unit is hour/min, a total operating time of 501 hours 30 minutes and 59 seconds is displayed as “**1.30**”.

- In FAST mode a setting of 0 or 1 displays the time according to FAST X.

● **C66 (SP limit lower limit)**

● **C67 (SP limit upper limit)**

- These settings operate as limiters when SP is set or changed in the program setting pattern items.
- In the program run mode these settings operate as limiters when SP and SP bias (variable parameter) set in a program are added to produce the resulting SP.
- These settings operate as limiters when SP is set or changed in constant value control data settings.
- In the constant value control mode these settings operate as limiters when SP and SP bias (variable parameter) set in constant value control data settings are added to produce the resulting SP.

●C93 (time proportional output system)

0: Does not go on a second time off in time proportional cycle.

1: Goes on a second time in time proportional cycle.

- This setting determines whether the output is to go on again after the result of a PID computation has changed in a time proportional cycle (cycle time) and the output has been turned off.
- The difference between the two settings is illustrated below.

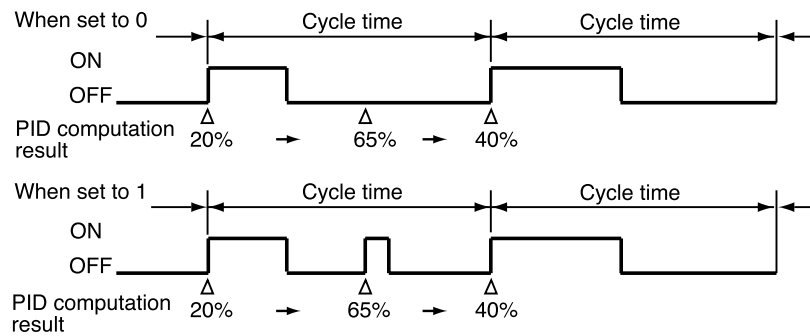

●C95 (voltage output control)

[Constant current type]

- Input current (maximum): Check that the input current is within the maximum allowable current or less, then the parallel connection can be made.
- Operating voltage range (input): Check that the voltage between the terminals of the voltage pulse output is within the specified range.

This example shows the calculation for the connection of this unit and the PGM10N015.

(Note: For connection with other model number, check the specifications of each model.)

- Input current(maximum): Since the input current is 10mA or less, up to two units (10mA X 2 = 20mA < 24mA [maximum allowable current]) can be connected in parallel.
- Operating voltage range (input): The rating voltage is 3.5 to 30Vdc. Therefore, terminal voltage when terminals are opened, is within the range.

Connection diagram

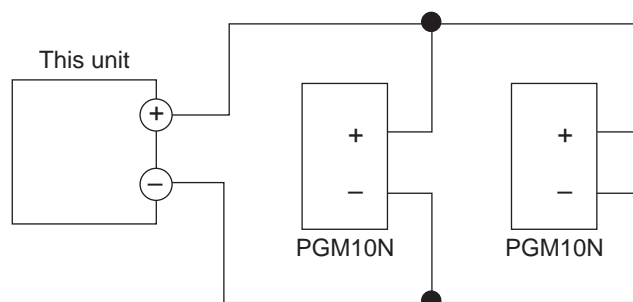

Example: Number of connectable units and settings

Settings		Model:6D(in case of C21=2 or 3)
		C95
PGM10N	1unit	10 or more
	2units(Parallel)	20 or more
PGM10F	1unit	12 or more

[Resistor type]

In a voltage time proportional output driven by SSR, the DCP551 must enter the SSR rated input voltage (optimum striking voltage of arc).

The DCP551 employs a newly developed variable output system that can output optimum striking voltage of arc to accommodate multiple SSR drives. A suitable current value is set on the DCP551 to obtain optimum striking voltage of arc for the internal impedance of the SSR. An equivalent circuit with related equations is shown below.

• Description of symbols

(1) Settings

- I_0 : set DCP551 output current (range: 2 to 22mA)
- V_0 : end-to-end load voltage (13.2V)
- $V_{SSR'}$: actual voltage input to SSR
- V_{SSR} : rated input voltage range for SSR ($V_{SSR/MIN}$ to $V_{SSR/MAX}$)
- $V_{SSR/MIN}$: minimum SSR rated input voltage
- $V_{SSR/MAX}$: maximum SSR rated input voltage
- Z : internal SSR impedance
- V_D : internal SSR voltage drop (normally about 1 to 2V)

(2) Equivalent circuit showing connection of one SSR

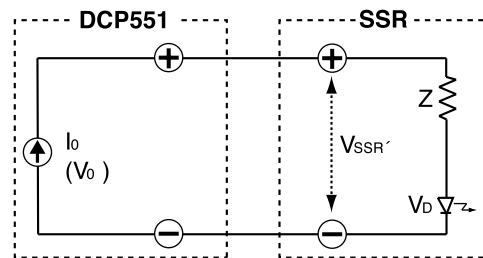

Equations [1] and [2] below must be satisfied.

$$V_{SSR/MIN} \leq I_0 \times Z + V_D \leq V_0 \quad \bullet \bullet \bullet \bullet [1]$$

$$V_{SSR'} \leq V_{SSR/MAX} \quad \bullet \bullet \bullet \bullet [2]$$

$$(V_{SSR'} = I_0 \times Z + V_D)$$

(3) Equivalent circuit showing connection of n SSRs

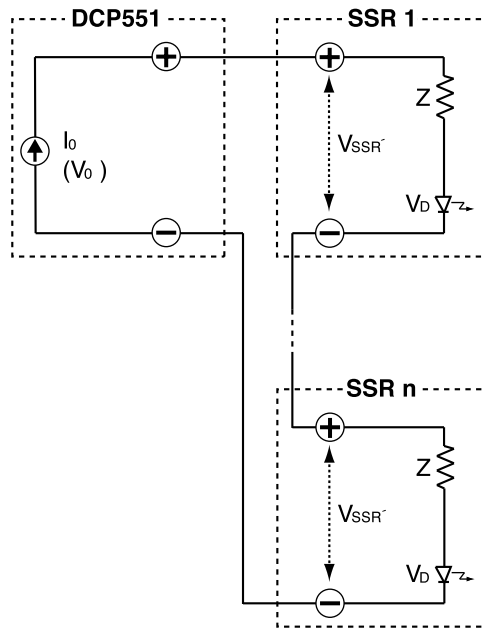

Equations [3] and [4] below must be satisfied.

$$V_{SSR/MIN} \leq I_0 \times Z + V_D \leq V_0 / N \quad \dots \dots [3]$$

$$V_{SSR'} \leq V_{SSR/MAX} \quad \dots \dots [4]$$

$$(V_{SSR'} = I_0 \times Z + V_D)$$

(4) Equivalent circuit showing parallel connection of n SSRs

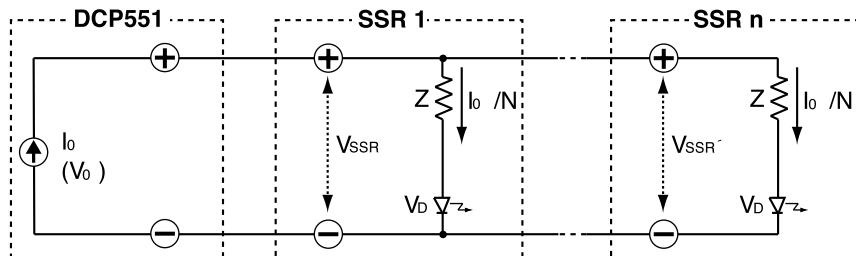

Equations [5] and [6] below must be satisfied.

$$V_{SSR/MIN} \leq I_0 / N \times Z + V_D \leq V_0 \quad \dots \dots [5]$$

$$V_{SSR'} \leq V_{SSR/MAX} \quad \dots \dots [6]$$

$$(V_{SSR'} = I_0 / N \times Z + V_D)$$

● **C99** (PV1 zener barrier adjustment)

● **C100** (PV2 zener barrier adjustment)

The adjustment described below must be performed when a zener barrier is used.

- (1) Turn off the DCP551. When installation and wiring is completed, short-circuit A and B on the resistance temperature detector.

• PV1 zener barrier adjustment

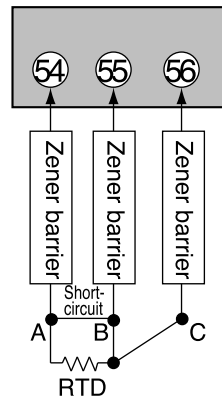

• PV2 zener barrier adjustment

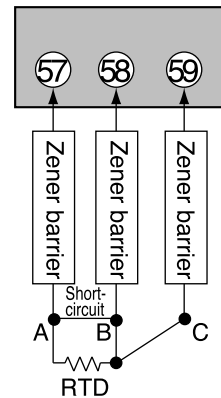

- (2) Turn on the DCP551 and set setup data **C98** to 241.

- (3) Display setup data **C99** and **C100**.

- (4) Press the **ENTER** key to display the difference in resistance (A-B) between zener barriers connected to wire A and wire B.

- (5) Press the **ENTER** key to store the difference in resistance values (A-B) in the DCP551.

- (6) Press the **DISP** key to return to the normal display mode.

- (7) Turn off the DCP551 and disconnect the wire between A and B.

! HANDLING PRECAUTIONS

- Adjust the resistance in the zener barriers connected to wire A and B to 20Ω or less. Adjustment is not possible if the resistance is higher than 20Ω.
- This adjustment is not required for inputs other than resistance temperature detectors or when zener barriers are not to be used.
- When a zener barrier has been adjusted, compensation is performed for this zener barrier. When resistance temperature detector inputs not employing zener barriers are to be used, perform the above adjustment without the zener barriers.

■ Constant value control data setting

No.	Item code	Item	Factory default settings	User settings	Settings and descriptions
1	<i>ConSt</i>	Control mode	0		0: Program run mode 1: Constant value control mode [Description:] When setup <i>C21</i> is set to 0, this setting is automatically set to 0.
2	<i>SP</i>	Setpoint	0		Within the range of setup <i>C66</i> to <i>C67</i> (SP limit)
3	<i>P</i>	Proportional band	100.0		0.0 to 1000.0% A setting of 0.0 turns on ON-OFF control
4	<i>I</i>	Integral time	0		0 to 3600sec No integral operation when set to 0. [Description:] When <i>P</i> is set to 0.0, "-----" is displayed and setting cannot be performed.
5	<i>d</i>	Derivative time	0		0 to 1200 sec No integral operation when set to 0. [Description:] When <i>P</i> is set to 0.0, "-----" is displayed and setting cannot be performed.
6	<i>rE</i>	Manual reset	50.0		0.0 to 100.0% [Description:] When <i>P</i> is set to 0.0, "-----" is displayed and setting cannot be performed. When <i>I</i> is not equal to 0, "-----" is displayed and setting cannot be performed.
7	<i>oL</i>	Manipulated variable lower limit	0.0		-5.0% to upper limit
8	<i>oH</i>	Manipulated variable upper limit	100.0		Lower limit to +105%

Chapter 8. PROGRAM SETUP

8-1 Program Setup

Programming is enabled in the normal display mode. When the DCP551 is not in the normal mode display, press the **DISP key** to invoke it. Programming is simpler if you set down the objectives of the program on a program work sheet before you start programming.

 **NOTE** For ease of use, please enlarge the copy of the **DCP551/552 Program Work Sheet** located after page 12-18.

■ Selecting number of program to operate

Numbers can be selected in one of two ways.

- before programming
- during programming

● Selecting program number before programming

Press the **PROG key** in the normal display mode in the READY mode. When the program number starts flashing, use the **PROG key** or the **↑, ↓, ←, or → key** to select a number.

HANDLING PRECAUTIONS

Program numbers cannot be selected during external switch input. See “**Section 6-3 Selecting Programs**” (page 6-7) for details.

● Selecting program number during programming

Press the **FUNC** and **PROG keys** in program setting state so that the program number starts to flash. Use the **↑, ↓, ←, or → key** to make the desired changes and press the **ENTER key** to enter them. Note, however, that you must after exiting the registration state (when set values flash) with the **ENTER key**, press the **FUNC** and **PROG keys**. When programs are selected in this way, the pattern items are displayed on the programming map.

This allows you to select a program number of a program other than the one processed in the RUN mode. It also allows you to select the number of another program using the external switches.

■ Starting programming

● Key operations

Start programming by pressing the **FUNC** and **PROG** keys in the normal display mode.

In the program setting state, PRG LED on the console lights and the decimal points in the program number display and the segment number display lights. Note, however, that the program setting state cannot be entered in the following cases.

- In the constant value control mode (and the constant value control data **ConSt** is set to 1)
 - When keylock is engaged (and variable parameters **PA01** is set to 2 or 3)
- In the following condition changes cannot be made in the program setting state.
- When a program is protected (and variable parameter **PA02** is set to 1, 3 or 5)

● Start of display items

When programming is started, the number of the started program and its segment are displayed.

■ State transition

The figure below shows the transition of states during programming.
The numbered items (1) to (19) are described on the following page.

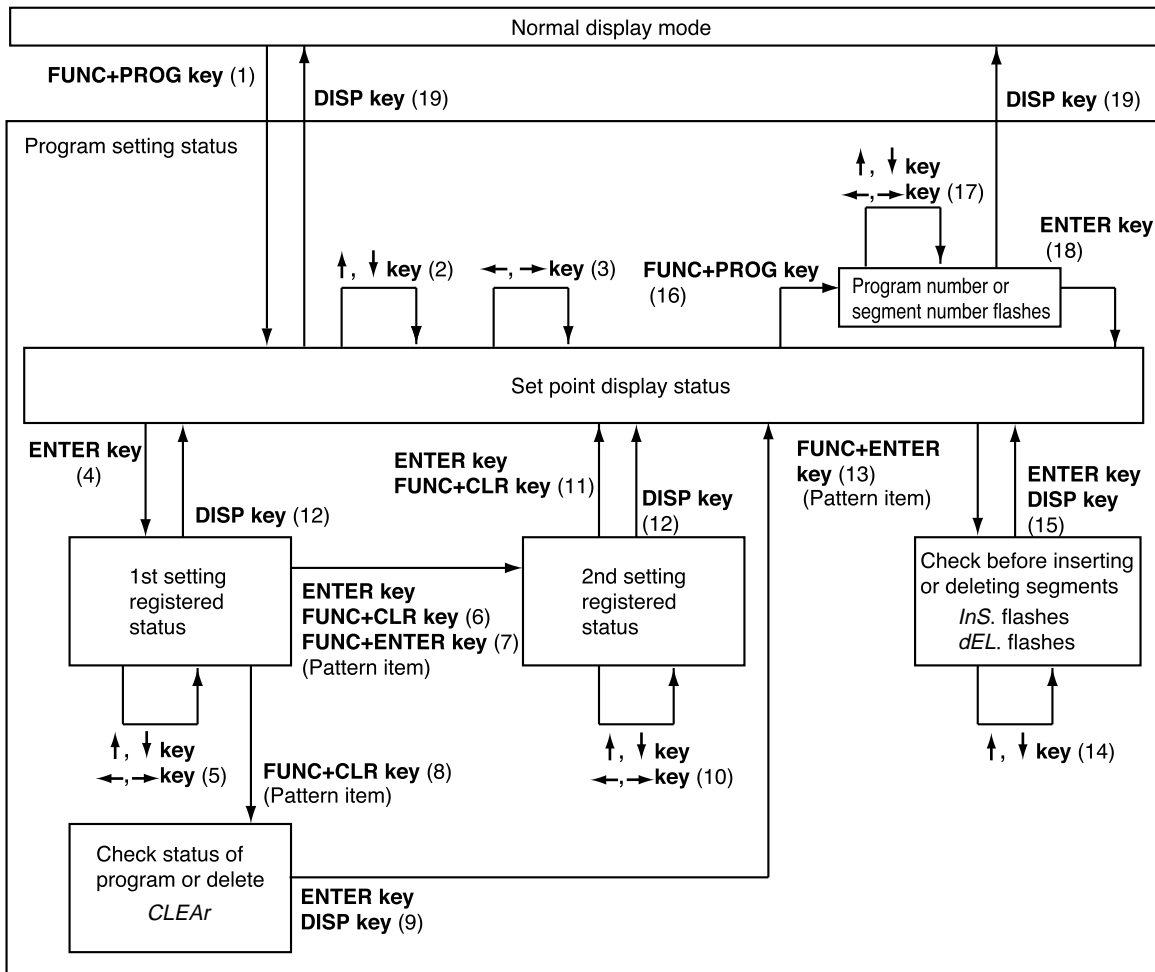

● **Description of numbered items in the figure illustrating the program setting state**

- (1) Programming is started. Up to about 1 second after the programming state is entered, the remaining number of segments is displayed in display panel 1 and the remaining number of subfunctions is displayed in display panel number 2. The display can be held by pressing the **FUNC key**.
- (2) Move the setting items on the programming map.
- (3) Move the segments on the programming map.
- (4) Register the first setting.
- (5) Increase or decrease the values in the first setting and move the flashing digits.
- (6) Complete the registration of the first setting.
Pressing the **ENTER key** registers the set value in memory.
For items with a second setting, the registration state for the second item is displayed. The display reverts to display set values for items without a second setting. Pressing the **FUNC** and **CLR keys** returns a segment to its initial state.
- (7) Use the **FUNC** and **ENTER keys** in pattern items to go between RAMP-X \Leftrightarrow RAMP-T and RAMP-X \Leftrightarrow RAMP-E. The setting in setup data **C61** determines the changeover that is actually performed.
Note, however, that a changeover cannot be made when a segment is running.
- (8) Use the **FUNC** and **CLR keys** in pattern items to display "**CLEAR**" to delete the program beyond that segment.
Note, however, that the **FUNC** and **CLR keys** are invalid when a program is running.
- (9) When the **ENTER keys** is used, the program beyond the point where the key was pressed is deleted. Pressing the **DISP key** does not delete any data but causes the display to show set values.
- (10) Increase or decrease the values in the second setting and move the flashing digits.
- (11) Complete the registration of the second setting.
Pressing the **ENTER keys** registers the set value in memory.
Pressing the **FUNC** and **CLR keys** returns a segment to its initial state.
- (12) Complete the registration without entering the value in memory.
- (13) Pressing the **FUNC** and **ENTER keys** in pattern items displays the segment insertion and deletion panel "**InS.**" flashes.
Note, however, that the **FUNC** and **ENTER keys** are invalid when a program is running.
- (14) Use the \downarrow **key** to delete and the \uparrow **key** to insert the flashing item.
- (15) Pressing the **ENTER keys** when "**InS.**" is displayed inserts the segment.
Pressing the **ENTER keys** when "**DEL.**" is displayed deletes the segment.
Pressing the **DISP key** neither deletes or inserts the segment.
- (16) Press the **FUNC** and **PROG keys** so that the program number starts to flash.
- (17) Program numbers and segment numbers can be increased or decreased and the moving digits can be moved.
- (18) Pressing the **ENTER keys** completes the registration of program and segment numbers.
- (19) The normal display mode appears.

■ Programming map

As shown below, a programming map consists of columns of segment numbers and rows of program setting items.

In the program setting state, the items in the solid lines indicated by the segment numbers and program setting items are displayed.

← **key**, → **key** : moves segments right and left

↑ **key**, ↓ **key** : moves segments up and down

The figure shows a programming map from the first to the 10th segment.

Programming map example:

Items cannot be moved to the gray area.
Settings in the gray area are shared with segment 1.

Segment number		1	2	-----	10	11	12 to 99	Remarks
Program item	(1) No.1 setting (2) No.2 setting							
Pattern	(1) SP (2) Time	100 0:30	100 3:00		100 10:00	----- -----		*1
Event 1	(1) Operating point	1100	-----		-----			*2
Event 2	(1) Operating point	-----	30		-----			
Event 3	(1) On Time (2) Off Time	0:00 0:01	0:00 0:01		0:00 0:01			
Event 4	(1) On Time (2) Off Time	----- -----	0:00 1:00		----- -----			
Event 5	(1) Code	1	2		3			
Event 7-1	(1) Code (2) Time	1 0:10	--- ---		2 5:00			
Event 7-2	(1) Code (2) Time	0 0:20	--- ---		3 9:00			
PIG group, output limiter group	(1) PID group (2) Output limiter group	3 3	A 1		1 7			*3
G.SOAK	(1) Type (2) G.SOAK width	0 -----	2 5		1 10			
PV shift	(1) Shift value	-----	-----		-----			
Repeat	(1) Return destination segment (2) Count	0 -----	0 -----		0 -----			
PV start	(1) Type	0	0		0			*4
Cycle	(1) Count	0	0		0			
Pattern link	(1) Link destination program	0	0		0			
Tag	(1) 8 character tag	PROG9999	PROG9999		PROG9999			

- *1 : Items up to segment 10 has been entered.
- *2 : The event types of each event are listed below.
 - Event 1/2 : PV upper limit (event type setting 2)
 - Event 3/4 : time event (event type setting 1)
 - Event 5 : code event using two points
(event type setting 18, auxiliary setting 2)
 - Event 7 : time code event using two points
(event type setting 23, auxiliary setting 2)
 - Event 9 to 16: event off (event type setting 0)
- *3 : Use of controller function (setup data **C21** is set to something other than 0)
- *4 : These are settings used in each program and are shared by all segments.

■ Display items

Items displayed are shown in the figure below.

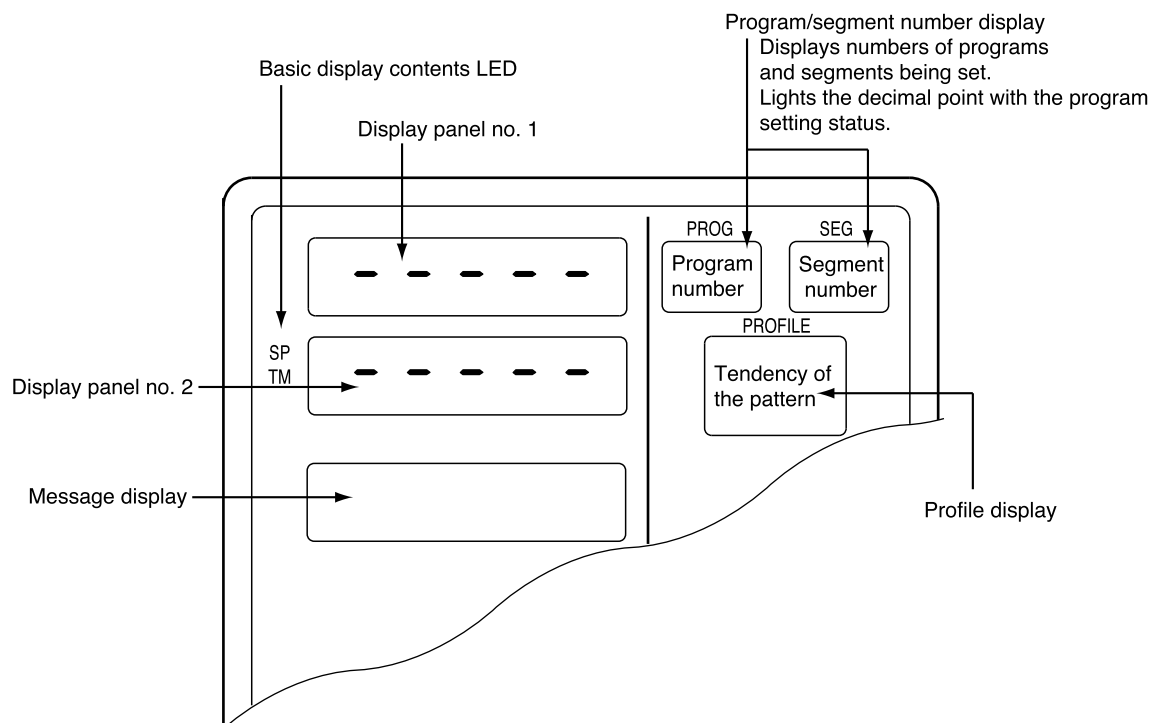

■ Setting pattern items

- (1) In the set value display state, move to the segment pattern item to be set on the programming map.
- (2) Press the **ENTER key** to make display panel 1 flash (registration of first setting).
- (3) Use the **↑, ↓, ←, and → keys** to set the first setting (SP).
Setting range: SP limit lower limit to upper limit
(SP limit is set using setup data **C66** and **C67**.)
- (4) Pressing the **ENTER key** stops display panel 1 from flashing and causes display panel 2 to start flashing. (This starts start registration of the second setting.) Instead of pressing the **ENTER key**, press the **FUNC** and **ENTER keys** to switch between RAMP types (selecting RAMP-X \leftrightarrow RAMP-T, or RAMP-X \leftrightarrow RAMP-E is made with setup data **C61**).
- (5) Use the **↑, ↓, ←, and → keys** to make the second setting (time).
Setting range: 0:00 to 500:00, 0.0 to 3000.0
(Time units are selected using setup data **C62** to set Hour/min, Min/sec, 0.1 sec.
Since a colon “:” cannot be displayed, the decimal point is used instead.)
- (6) Press the **ENTER key** to stop display panel 2 from flashing.

● Display

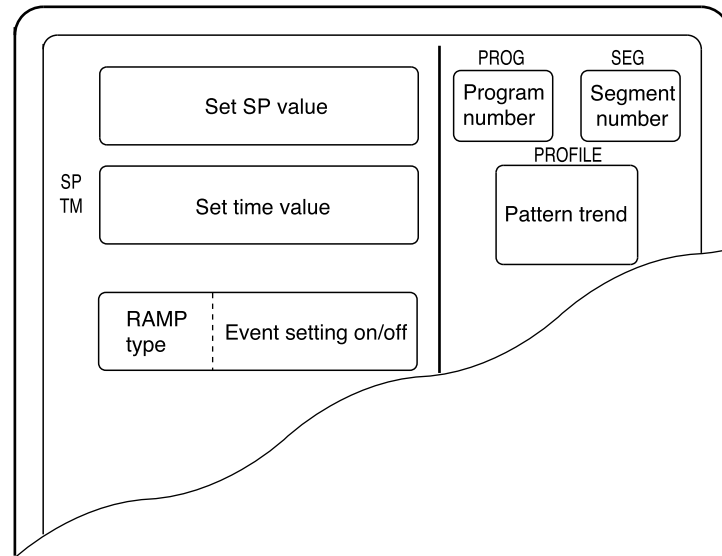

Segments that have not been set and unset values for SP and time are indicated by “----”.

NOTE

Event settings are displayed in the two rows of the message panel. Events 1 to 8 are displayed in the top row and events 9 to 16 are displayed in the lower row. The meaning of the codes used are listed below.

- : event off
- T : time event
- P : PV/PV deviation rate event
- D : Deviation/absolute deviation
- M : MV event
- S : SP event
- C : code/time code event

■ Setting event items

! HANDLING PRECAUTIONS

Note that when setup data C57 is set to 1, event items on the programming map are skipped and not displayed.

● When the event is a PV event

- (1) In the set value display state, move to the segment event item to be set on the programming map.
- (2) Press the **ENTER key** to make display panel 1 flash (registration of first setting).
- (3) Use the **↑, ↓, ←, and → keys** to make the first setting – setting the event operating point.

Setting range : OFF –19999 to +20000 SPU

: OFF 0 to 20000 SPU (for absolute value deviation events)

: OFF –5.0 to +105.0% (for MV events)

- (4) Press the **ENTER key** to stop the flashing on display panel 1. (Pressing the **FUNC** and **CLR keys** causes display panel 1 to return to unset state “-----” and the flashing stops.)

● Display (PV events)

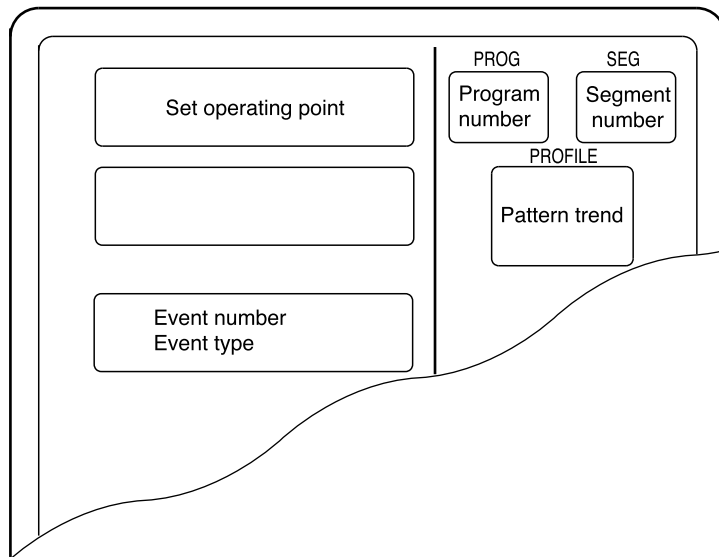

Unset values are indicated as “-----”.

📖 NOTE

A PV event setting consists of a setting (including OFF) and a subfunction. A subfunction cannot be used when a setting has not been made “-----”.

● When the event is a time event

- (1) In the set value display state, move to the event item to be set for the segment on the programming map.
- (2) Press the **ENTER key** to make display panel 1 flash (registration of first setting).
- (3) Use the **↑, ↓, ←, and → keys** to make the first setting (On Time setting).
Setting range: 0:00 to 500:00, 0.0 to 3000.0
(Time units are selected using setup data **C62** to set Hour/min, Min/sec, 0.1 sec.
Since a colon “:” cannot be displayed, the decimal point is used instead.)
- (4) Press the **ENTER key** to stop the flashing on display panel 1 and display panel 2 starts flashing. (Start of second setting)
(Pressing the **FUNC** and **CLR keys** causes display panel 1 and 2 to return to unset state “-----” and the flashing stops.)
- (5) Use the **↑, ↓, ←, and → keys** to make the second setting (Off Time setting).
Setting range: On time setting +0:01 to 500:00, Off time setting +0.1 to 3000.0
- (6) Press the **ENTER key** to stop the flashing on display panel 2.
(Pressing the **FUNC** and **CLR keys** causes display panel 2 to return to unset state “-----” and the flashing stops.)

● Display (time event)

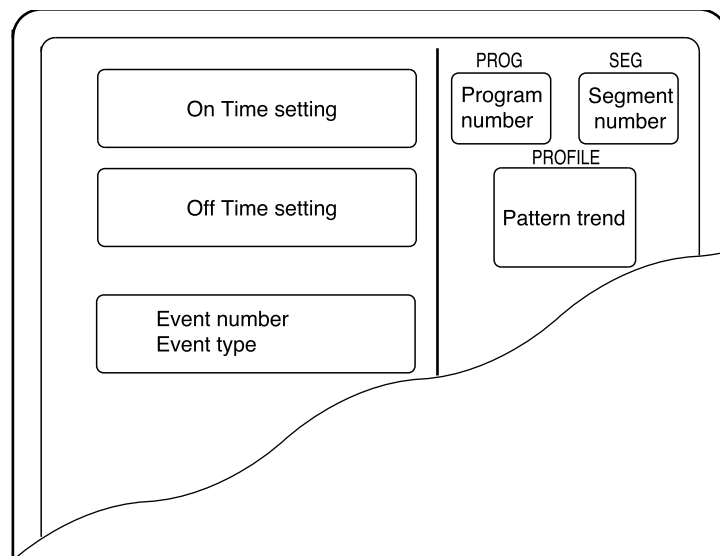

- Unset values are indicated as “-----”.
- When the On Time is set to 500:00 or 3000.0, an Off Time cannot be set.

NOTE A time event setting consists of one setting, an On Time, or two settings, an On Time and an Off Time. When both settings are made a subfunction can be used. In unset state “-----” a subfunction cannot be used.

HANDLING PRECAUTIONS

In a time event, an On Time or Off Time setting that is the same as or exceeds the segment time is invalid.

Note, however, that when there is a G.SOAK wait at the end of a segment or an END mode at the end of a program, an On Time or Off Time setting that is the same as the segment time is valid.

● When the event is a code event

- (1) In the set value display state, move to the event item to be set for the segment on the programming map.
- (2) Press the **ENTER key** to make display panel 1 flash (registration of first setting).
- (3) Use the **↑, ↓, ←, and → keys** to make the first setting – setting the event output code.

Setting range: 0 to $2^n - 1$

(n indicates the number of output points set in event configuration 1 auxiliary setting 1.)

- (4) Press the **ENTER key** to stop the flashing on display panel 1.
(Pressing the **FUNC** and **CLR keys** causes display panel 1 to return to unset state “-----” and the flashing stops.)

● Display (code event)

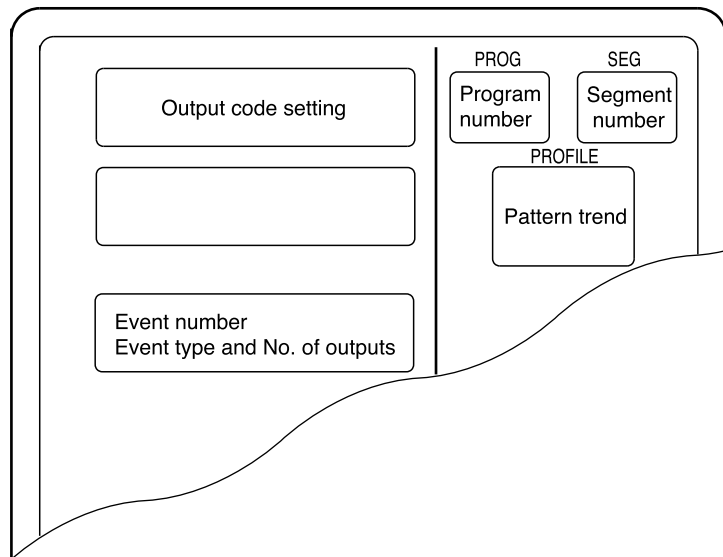

Unset values are indicated as “-----”.

 **NOTE**

Code events use one subfunction. A subfunction cannot be used when a setting has not been made “-----”.

Events that follow the event number of a code event (number of output points less 1) are skipped and not displayed.

● When the event is a timer code event

- (1) In the set value display state, move to the event item to be set for the segment on the programming map.
- (2) Press the **ENTER key** to make display panel 1 flash (registration of first setting).
- (3) Use the **↑, ↓, ←, and → keys** to make the first setting (output code).
 Setting range: 0 to $2^n - 1$
 (n indicates the number of output points set in event configuration 1 auxiliary setting 1.)
- (4) Press the **ENTER key** to stop the flashing on display panel 1 and display panel 2 starts flashing. (Start of second setting)
 (Pressing the **FUNC** and **CLR keys** causes display panel 1 and 2 to return to unset state “-----” and the flashing stops.)
- (5) Use the **↑, ↓, ←, and → keys** to make the second setting (time).
 Setting range: 0:00 to 500:00, 0.0 to 3000.0
 (Time units are selected using setup data **C64** to set Hour/min, Min/sec, 0.1 sec. Since a colon “:” cannot be displayed, the decimal point is used instead.)
- (6) Press the **ENTER key** to stop the flashing on display panel 2.
 (Pressing the **FUNC** and **CLR keys** causes display panel 1 and 2 to return to unset state “-----” and the flashing stops.)

● Display (Code event with a timer function)

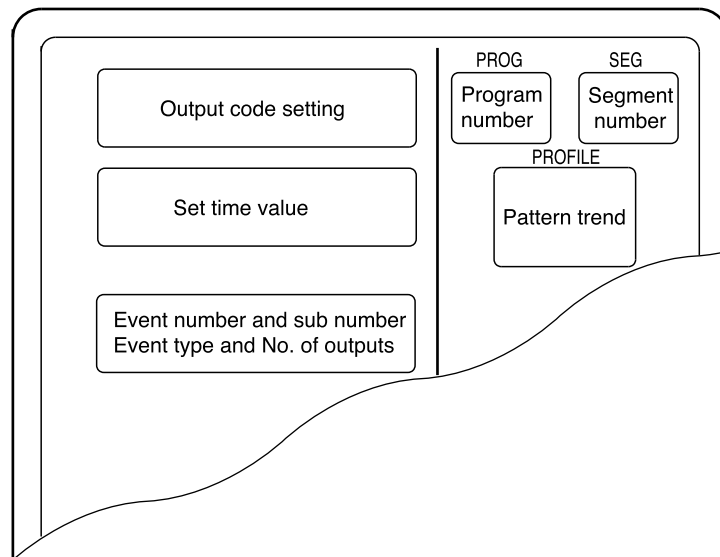

Unset values are indicated as “-----”.

 **NOTE**

Timer code events use one subfunction. A subfunction cannot be used when a setting has not been made “-----”.
 Events that follow the event number of a timer code event (number of output points less 1) are skipped and not displayed.

! **HANDLING PRECAUTIONS**

In a timer code event, an On Time or Off Time setting that is the same as or exceeds the segment time is invalid.

Note, however, that when there is a G.SOAK wait at the end of a segment or an END mode at the end of a program, an On Time or Off Time setting that is the same as the segment time is valid.

● **When the event is an event off**

Such event items on the programming map are skipped and not displayed.

● **When the event is an instrument event**

Such event items on the programming map are skipped and not displayed.

■ Setting PID groups and output limiter group number items

- (1) In the set value display state, move to the PID group, output limiter group number item to be set for the segment on the programming map.
- (2) Press the **ENTER key** to make display panel 1 flash (registration of first setting).
- (3) Use the **↑, ↓, ←, and → keys** to make the first setting (PID group number).
Setting range: ON-OFF, PID 0 to 9, PID A
- (4) Press the **ENTER key** to stop the flashing on display panel 1 and display panel 2 starts flashing. (Start of second setting)
(Pressing the **FUNC** and **CLR keys** causes display panel 1 and 2 to return to unset state “*Pld 0/otL 0*” and the flashing stops.)
- (5) Use the **↑, ↓, ←, and → keys** to make the second setting (output limiter group number).
Setting range: 0 to 9
- (6) Press the **ENTER key** to stop the flashing on display panel 2.
(Pressing the **FUNC** and **CLR keys** causes display panel 2 to return to unset state “*Pld 0/otL 0*” and the flashing stops.)

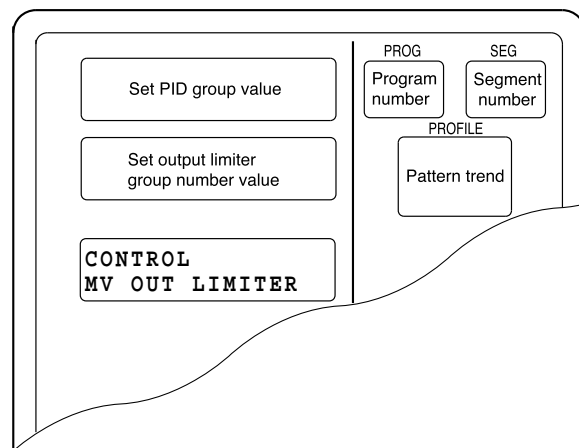

● Display

- Unset values are indicated as “*Pld 0/otL 0*”.
- When setup data **C21** is set to 0 and the programmer function is selected or when **C58** is set to 1, PID groups, output limiter group number items are skipped and not displayed.

📖 NOTE

When a PID group or output limiter group number is not 0 or both are something other than 0, they use a subfunction. A subfunction cannot be used when a setting has not been made “*Pld 0/otL 0*”.

! HANDLING PRECAUTIONS

- When a set value for a PID group number is 0, it is a sequel to a PID number in a previous segment. When the set value for a PID group number in the first segment is 0, the set value is 1.
- When a set value for an output limiter group number is 0, it is a sequel to an output limiter group number in a previous segment. When the set value for an output limiter group number in the first segment is 0, the set value is 1.

■ Setting G.SOAK (Guarantee soak) items

- (1) In the set value display state, move to the G.SOAK item to be set for the segment on the programming map.
- (2) Press the **ENTER key** to make display panel 1 flash (registration of first setting).
- (3) Use the **↑, ↓, ←, and → keys** to make the first setting – setting the G.SOAK type.
Setting range: 0 to 3
 - 0: No G.SOAK
 - 1: First G.SOAK segment
 - 2: Last G.SOAK segment
 - 3: Entire G.SOAK segment
- (4) Press the **ENTER key** to stop the flashing on display panel 1 and display panel 2 starts flashing. (Start of second setting)
Note, however, that when the first setting is 0, “-----” is shown in the second panel which does not flash.
(Pressing the **FUNC** and **CLR keys** causes display panel 1 and 2 to return to unset state “**g.S.0/-----**” and the flashing stops.)
- (5) Use the **↑, ↓, ←, and → keys** to make the second setting (G.SOAK width).
Setting range: 0 to 1000 SPU
- (6) Press the **ENTER key** to stop the flashing on display panel 2.
(Pressing the **FUNC** and **CLR keys** causes display panel 1 and 2 to return to unset state “**g.S.0/-----**” and the flashing stops.)

● Display

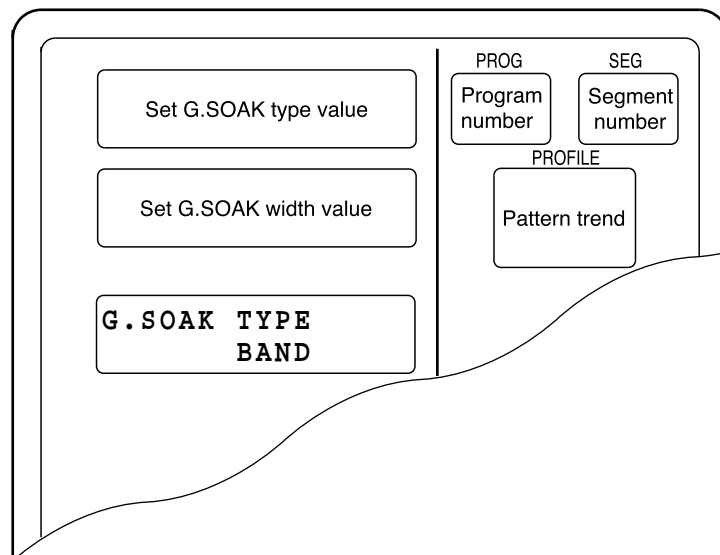

- Unset values are indicated as “**g.S.0/-----**”.
- When setup data **C59** is set to 1, a G.SOAK item on the programming map is skipped and not displayed.

📖 NOTE

When a G.SOAK setting is something other than 0, it uses a subfunction. A subfunction cannot be used when a setting has not been made “**g.S.0/-----**”.

■ Setting PV shift items

- (1) In the set value display state, move to the PV shift item to be set for the segment on the programming map.
- (2) Press the **ENTER key** to make display panel 2 flash (registration of first setting).
- (3) Use the **↑, ↓, ←, and → keys** to make the first setting – setting the PV shift set value.

Setting range: -10000 to +10000 SPU

- (4) Press the **ENTER key** to stop the flashing on display panel 2.
(Pressing the **FUNC** and **CLR keys** causes display panel 1 to return to unset state “-----” and the flashing stops.)

● Display

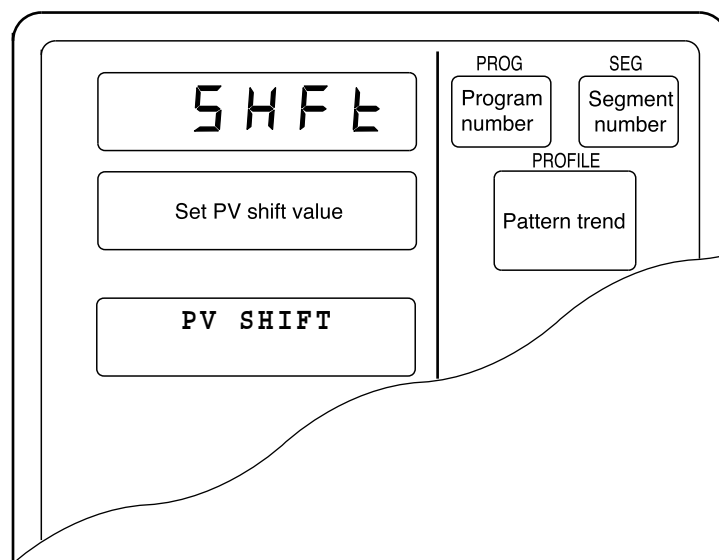

- Unset values are indicated as “-----”.
- When setup data **C59** is set to 1, a PV shift item on the programming map is skipped and not displayed.

NOTE PV shift uses a subfunction. A subfunction cannot be used when a setting has not been made “-----”.

! HANDLING PRECAUTIONS

- When PV shift is not set, it is a sequel to a PV shift value in a previous segment. When PV shift is not set in the first segment, the set value is 0.

■ Setting repeat items

- (1) In the set value display state, move to the repeat item to be set for the segment on the programming map.
- (2) Press the **ENTER key** to make display panel 1 flash (registration of first setting).
- (3) Use the **↑, ↓, ←, and → keys** to make the first setting – setting the number of the return segment.

Setting range: 0 to segment number in setting

- (4) Press the **ENTER key** to stop the flashing on display panel 1 and display panel 2 starts flashing. (Start of second setting)

Note, however, that when the first setting is 0, “-----” is shown in the second panel which does not flash.

(Pressing the **FUNC** and **CLR keys** causes display panel 1 and 2 to return to unset state “**rP.0/-----**” and the flashing stops.)

- (5) Use the **↑, ↓, ←, and → keys** to make the second setting (repeat segment times).

Setting range: 1 to 10000

- (6) Press the **ENTER key** to stop the flashing on display panel 2.

(Pressing the **FUNC** and **CLR keys** causes display panel 1 and 2 to return to unset state “**rP.0/-----**” and the flashing stops.)

● Display

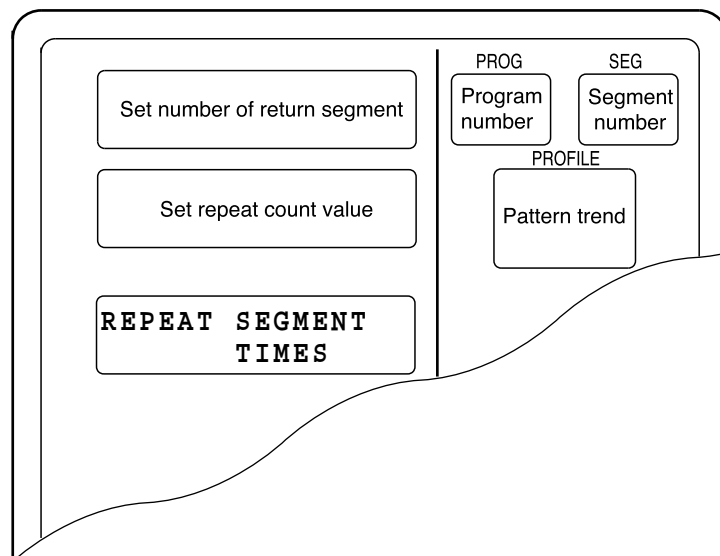

- Unset values are indicated as “**rP.0/-----**”.
- When setup data **C59** is set to 1, a repeat item on the programming map is skipped and not displayed.

📖 NOTE

When the number of return segment is something other than 0, it uses a subfunction. A subfunction cannot be used when a setting has not been made “**rP.0/-----**”.

■ Setting PV start items

(1) In the set value display state, move to the PV start item to be set for the segment on the programming map.

(A PV start item is a program setting and is the same for each segment.)

(2) Press the **ENTER key** to make display panel 2 flash (registration of first setting).

(3) Use the **↑, ↓, ←, and → keys** to make the first setting – setting the PV start value.

Setting range: 0 to 3

0: no PV start

1: descending PV start

2: ascending PV start

3: bi-directional PV start

(4) Press the **ENTER key** to stop the flashing on display panel 2.

(Pressing the **FUNC** and **CLR** keys causes display panel 2 to return to unset state “0” and the flashing stops.)

● Display

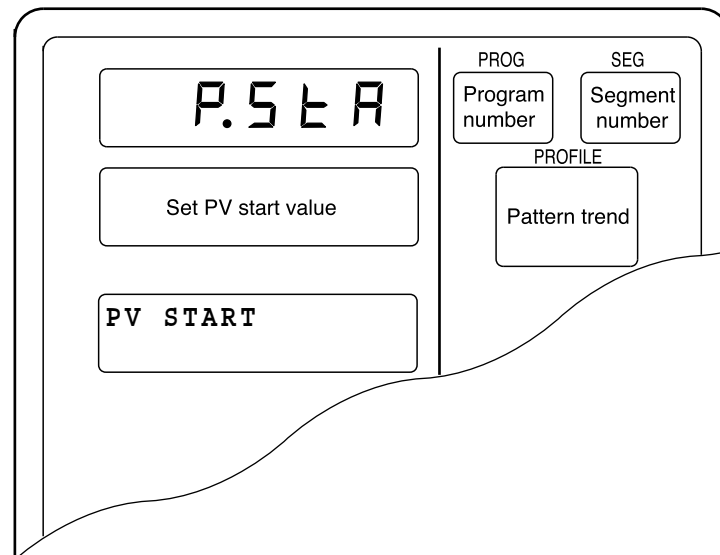

- A PV start item is a program setting and is the same for each segment.
- When setup data **C60** is set to 1, a PV start item on the programming map is skipped and not displayed.

 **NOTE** A PV start item setting does not use subfunctions.

■ Setting cycle items

- (1) In the set value display state, move to the cycle item to be set for the segment on the programming map.
(A cycle item is a program setting and is the same for each segment.)
- (2) Press the **ENTER key** to make display panel 2 flash (registration of first setting).
- (3) Use the **↑, ↓, ←, and → keys** to make the first setting – setting the cycle value.
Setting range: 0 to 10000
- (4) Press the **ENTER key** to stop the flashing on display panel 2.
(Pressing the **FUNC** and **CLR keys** causes display panel 2 to return to unset state “0” and the flashing stops.)

● Display

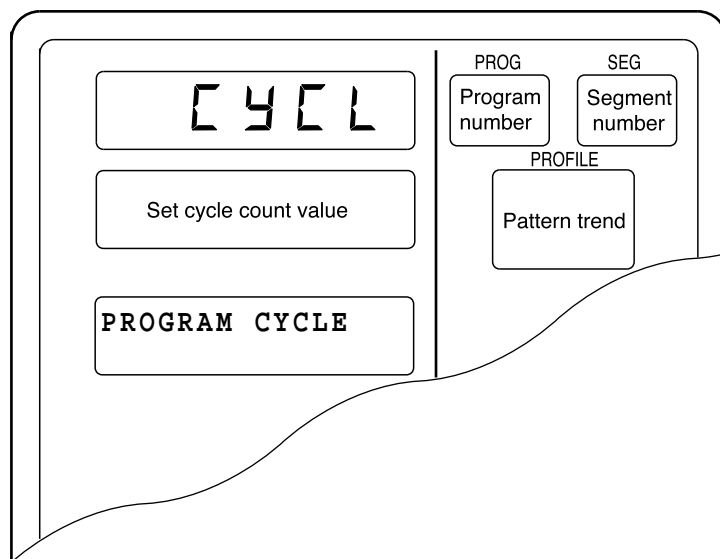

- A cycle item is a program setting and is the same for each segment.
- When setup data **C60** is set to 1, a cycle item on the programming map is skipped and not displayed.

📖 NOTE

A cycle item setting does not use subfunctions.

■ Setting pattern link items

(1) In the set value display state, move to the pattern link item to be set for the segment on the programming map.

(A pattern link item is a program setting and is the same for each segment.)

(2) Press the **ENTER** key to make display panel 2 flash (registration of first setting).

(3) Use the **↑**, **↓**, **←**, and **→** keys to make the first setting – setting the pattern link value.

Setting range: 0 to 99

0 : no pattern link

1 to 99: program number at pattern link destination

(4) Press the **ENTER** key to stop the flashing on display panel 2.

(Pressing the **FUNC** and **CLR** keys causes display panel 2 to return to unset state “0 ”and the flashing stops.)

● Display

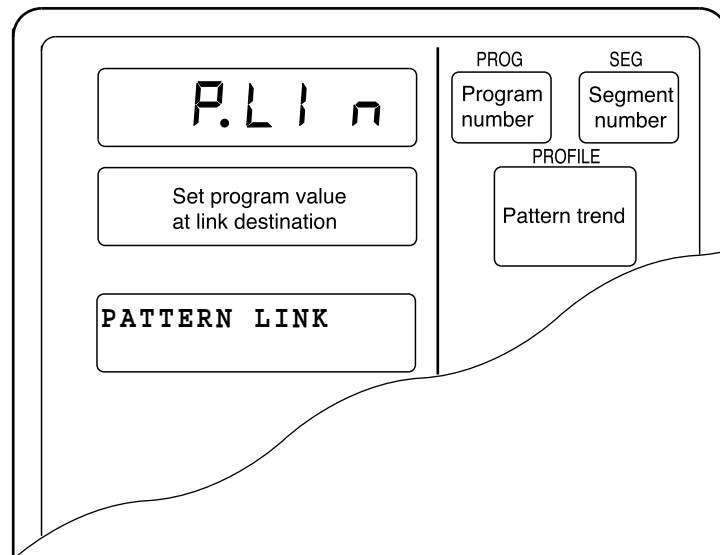

- A pattern link item is a program setting and is the same for each segment.
- When setup data **C60** is set to 1, a pattern link item on the programming map is skipped and not displayed.



NOTE A pattern link item setting does not use subfunctions.

■ Setting tag items

- (1) In the set value display state, move to the tag item to be set for the segment on the programming map.
(A tag item is a program setting and is the same for each segment.)
- (2) Press the **ENTER key** to display the cursor “_” below the leftmost of the 8 characters in the message panel “[]” field (registration of first setting).
- (3) Use the **↑, ↓, ←, and → keys** to make the first setting – selecting the 8 characters for the tag. The table below shows the 128 characters that can be used.
- (4) Press the **ENTER key** and the cursor in the message panel disappears.
(Pressing the **FUNC** and **CLR keys** causes the message panel return to displaying an 8-character tag consisting of “**PROG**”, a two-digit program number and two space characters. The cursor is turned off.)

● Display

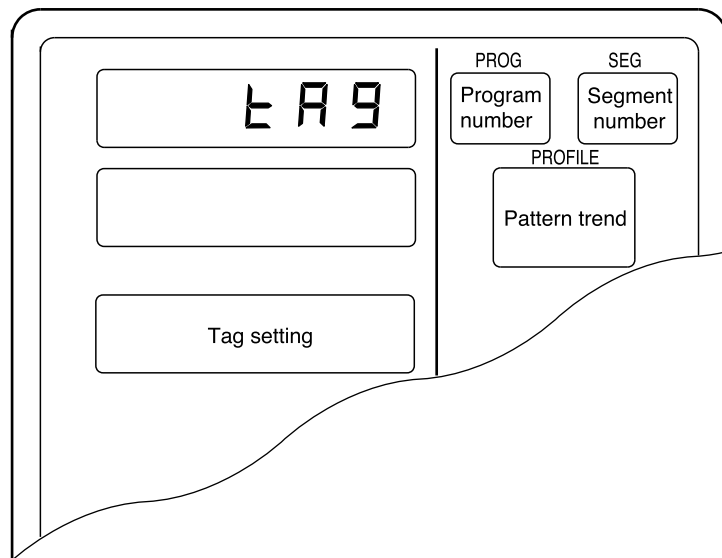

'	/	7	?	G	O	W	_	ア	ツ	キ	ソ	ヌ	マ	ラ	°
&	.	6	>	F	N	V	^	ヲ	ヨ	カ	セ	ニ	ホ	ヨ	°
%	-	5	=	E	M	U]	・	ユ	オ	ス	ナ	ヘ	ユ	ン
\$,	4	<	D	L	T	\	、	ャ	エ	シ	ト	フ	ヤ	ワ
#	+	3	;	C	K	S	[」	オ	ウ	サ	テ	ヒ	モ	ロ
”	*	2	:	B	J	R	Z	「	エ	イ	コ	ツ	ハ	メ	レ
!)	1	9	A	I	Q	Y	。	ウ	ア	ケ	チ	ノ	ム	ル
	(0	8	@	H	P	X		ィ	ー	ク	タ	ネ	ミ	リ

NOTE A tag item setting does not use subfunctions.

■ Deleting programs

- (1) In the set value display state, move to the start of the segment pattern item to be deleted on the programming map.
Move to the first segment of the program to delete the entire program.
- (2) Press the **ENTER key** to make display panel 1 flash (registration of first setting).
(This the same as for pattern item settings.)
- (3) Press the **FUNC** and **CLR keys** and you are prompted to confirm program deletion.
“**CLEAR**” flashes in display panel 1.
- (4) Press the **ENTER key** to delete the program.
- (5) The set value display state appears and “-----” is shown in both display panel 1 and 2.

● Display

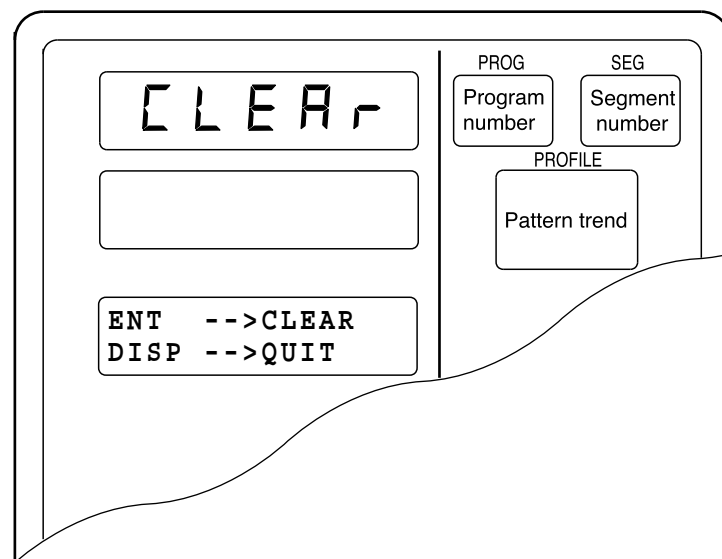

- Segments that have not been set and unset values for SP and time are indicated by “-----”.
- A program that is running (in RUN, HOLD, FAST, END or READY FAST mode) cannot be deleted.

■ Inserting and deleting segments

- (1) In the set value display state, move to insert segment or delete segment segment pattern item on the programming map.
- (2) Press the **FUNC** and **ENTER** keys and you are prompted to confirm segment insertion. “**InS.**” flashes in display panel 1.
- (3) Press the **↑** key and you are prompted to confirm segment insertion. “**InS.**” flashes in display panel 1. Press the **↓** key and you are prompted to confirm segment deletion. “**dEL.**” flashes in display panel 1.
- (4) Pressing the **ENTER** key when “**InS.**” is displayed in display panel 1 inserts the segment. Pressing the **ENTER** key when “**dEL.**” is displayed in display panel 1 deletes the segment.
- (5) The set value display state appears.

● Display (segment insertion)

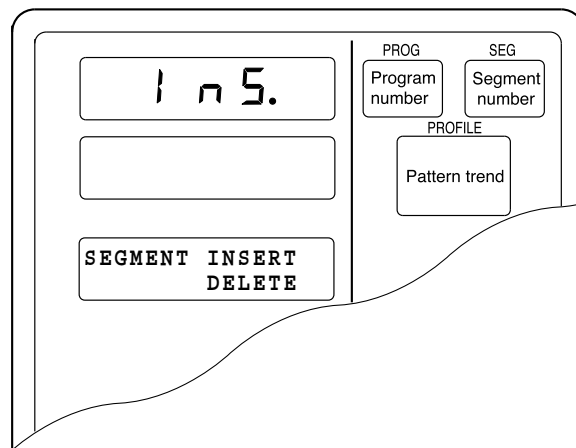

● Display (segment deletion)

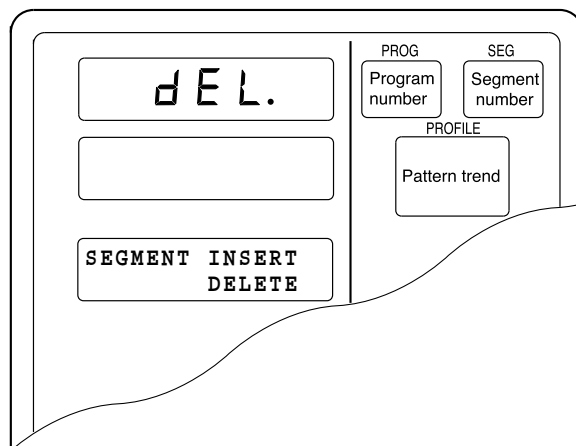

- When a segment is inserted, a new segment is automatically created and the numbers of subsequent segments are incremented by one.

The set value of the inserted segment is as follows:

Set SP value : same value as the original segment before insertion

Set time value : 0:10, 1.0

Event items, PID groups, output limiter group number items, G.SOAK items, PV shift items and repeat items are not set.

- When the 99th segment has already been set, the segment insertion indication “**InS.**” is not displayed.
- When 2000 segments have already been set, pressing the **ENTER key** to execute an insertion cannot be used to insert a segment.
- When segments are deleted, the following segments are moved up and the numbers of subsequent segments are decremented by one. When the final segment is deleted, the displayed segment becomes an unset segment.
- A program that is running (in RUN, HOLD, FAST, END or READY FAST mode) cannot be deleted.

8-2 Copying Programs

The DCP551 allows you to copy programs when it is in the READY program run mode. If not in this mode, press the **DISP key** to invoke the normal display mode.

■ Program copy procedures

- (1) Invoke the program run READY program run mode.
Set variable parameter **PA01** to 0 or 1 and set variable parameter **PA02** to 0.
- (2) Press the **PROG key** and the **↑, ↓, ←, and → keys** in the normal display mode to select the number of the program to be copied.
This is not possible when the program number is selected using external switch inputs.
See “Section 6-3 Selecting Programs” (page 6-7) for details.
- (3) Press the **↑ key** and the **PROG key** to display “**COPY**” in display panel 1. The number of the program to be copied starts to flash in display panel 2.
- (4) Press the **↑ and ↓ keys** and currently unset program numbers that can be used as numbers for the program to be copied start to flash.
When there are no unset numbers, “-----” is displayed in display panel 2.
- (5) Press the **ENTER key** to start program copy and display panel 2 stops flashing.
Repeat steps (4) and (5) to copy more programs.
- (6) When a program has been copied, press the **DISP key**.

● Display

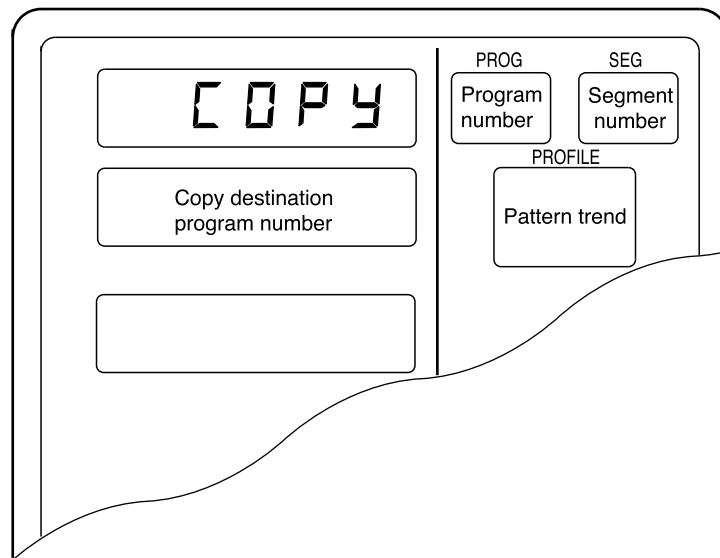

8-3 General Reset

A general reset can be performed when the controller is in the READY AUTO mode in the normal display mode. If not in the normal display mode, press the **DISP key** to invoke it. A general reset has the following functions. Program settings such as program numbers 1 to 99 are all deleted. Parameters are reset to their factory defaults and the READY AUTO program run mode is invoked.

■ General reset procedures

- (1) Invoke the READY AUTO mode. Or set variable parameters **PA01** and **PA02** to 0.
- (2) Press the **FUNC, CLR** and **MESSAGE keys** and you are prompted to confirm a general reset. “**g.rESt**” is displayed in display panel 1.
- (3) Press the **ENTER key** to execute the general reset and start startup operations that occur after a power up.
Press the **DISP key** cancels the general reset and returns the normal display mode.

● Display

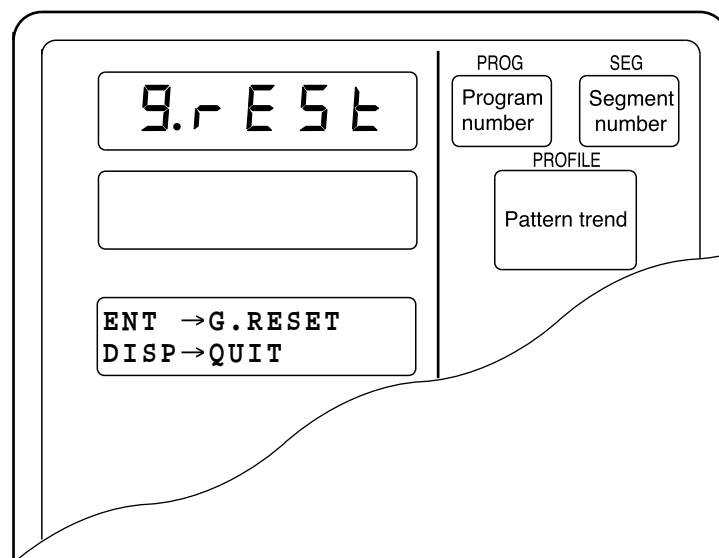

In the constant value control mode, program number, segment number and profile display go off.

- When the RAM backup fails at startup, the controller automatically prompts you to confirm a general reset – no key input is required - and “**g.rESt**” flashes in display panel 1.
Press the **ENTER key** to execute the general reset. All other keys are invalid.
- A general reset does not return the following settings to factory default values.
C01, C02, C11, C12, C21: these values are stored.

Note, however, that a general reset resulting from a RAM failure at startup resets also these settings to factory default values.

Chapter 9. MEMORY CARD OPERATIONS

9-1 Memory Card Type and Functions

A memory card can be used to store the setup data, variable parameters, PID parameters (including constant value control data), event configuration data and multiple programs required by one DCP551.

●Memory card types

The following memory cards can be used by the DCP551.

Model No.	Memory type	Battery	Capacity (Byte)	No. of programs
SKM008A	RAM	Not replaceable	7.00K	Max. 20
SKM016A	RAM	Not replaceable	14.50K	Max. 52
SKM064A	RAM	Not replaceable	61.75K	Max. 99
SKM256C	RAM	Replaceable	251.00K	Max. 99
SKM008E	E ² PROM	Not necessity	7.00K	Max. 20
SKM032E	E ² PROM	Not necessity	29.75K	Max. 99

●Memory card functions

- **Save: (write)**
Saves selected DCP551 data on the memory card.
- **Load: (read)**
Loads selected memory card data onto the DCP551.

9-2 Save Procedures

Insert a memory card when the DCP551 is in the READY mode and the normal display mode. Press the **SAVE key** to start a save operation. “**Card**” is displayed in display panel 1 and “**SAVE**” is displayed in display panel 2. An error code appears if something should go wrong during the save operation.

■ Save menu

When the **SAVE key** is pressed in the normal display mode, the save menu panel is displayed. Use the **↑** and **↓** keys to select the desired menu.

Press the **ENTER key** to display the desired menu in the message display panel. The **DISP key** returns you to the normal display mode.

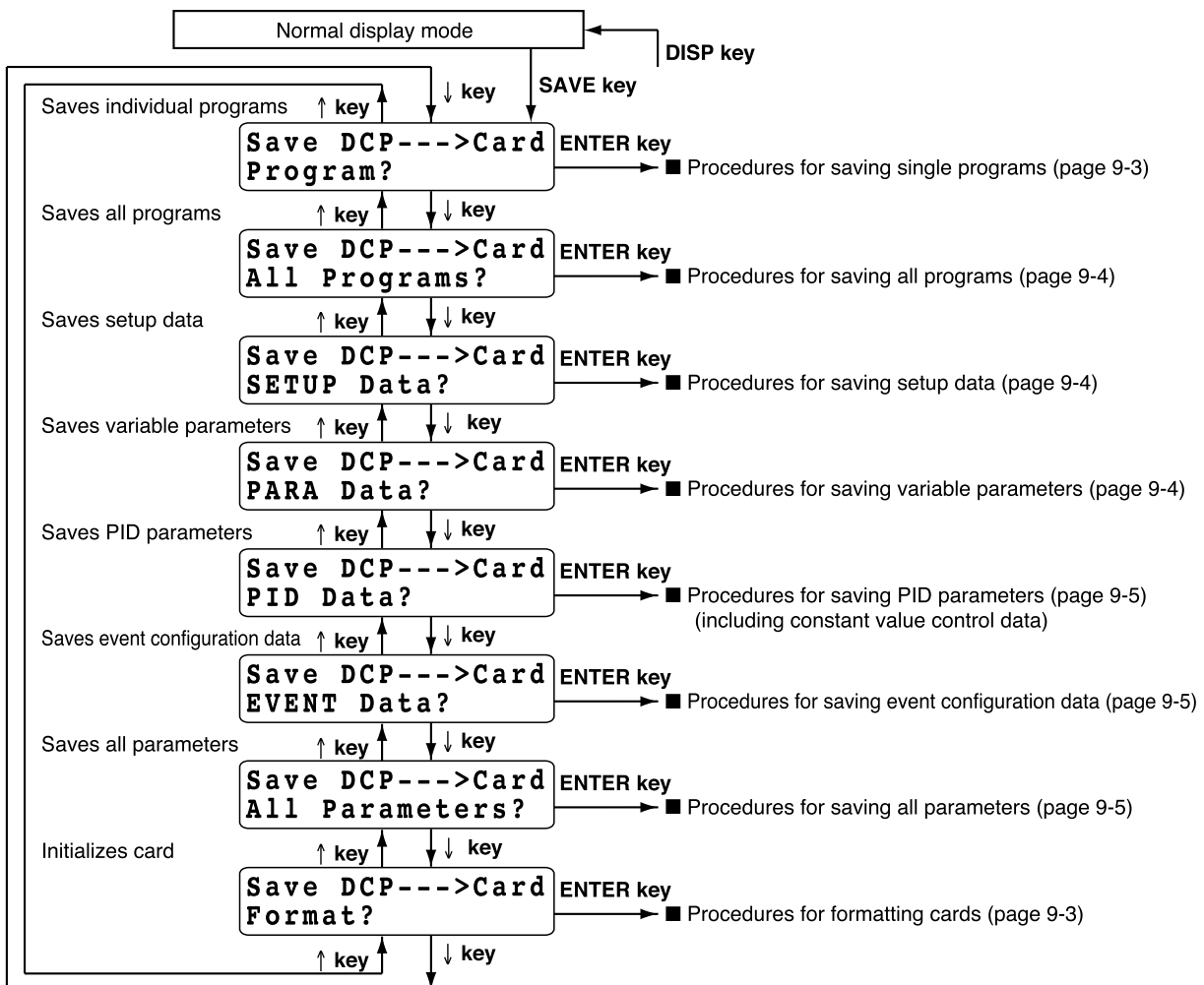

■ Procedures for formatting cards

This procedure is used to format memory cards so that they can be used with the DCP551. A card has to be formatted once only. Note that any programs or parameters on a card that is formatted are deleted in this process.

Initialize check

```
Card Format
Prog. & parmt. ?
```

Initialize complete

↓ ENTER key

```
Card Format
Good
```

DISP key

→ Normal mode display

■ Procedures for saving single programs

This procedure is used to save one program on the DCP to a memory card.

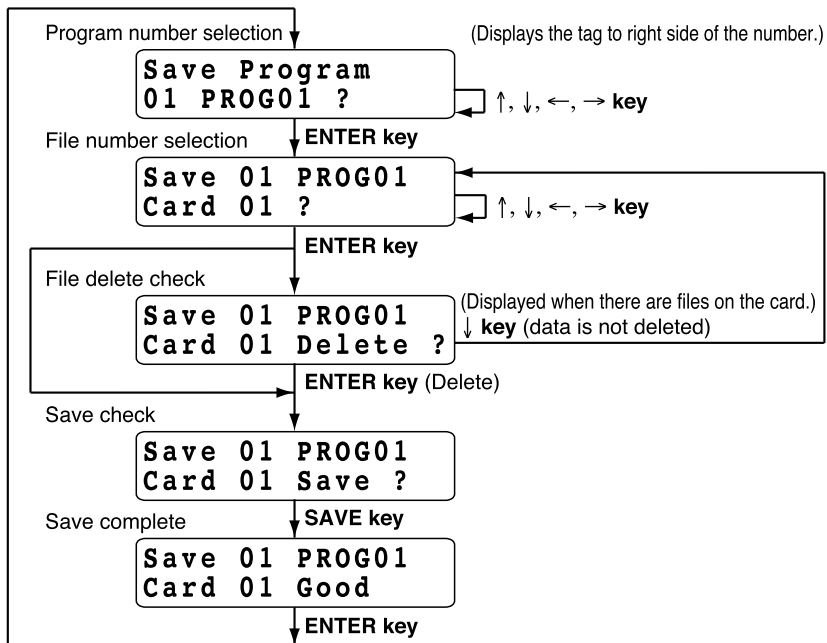

■ Procedures for saving all programs

This procedure saves all programs on the DCP551 on a memory card. The program numbers used in the DCP551 are converted to file names on the memory card.

When the “Overwrite” save function is selected, files on the card that have the same number as those in the DCP551 are overwritten by the DCP551 files.

When the “Skip” save function is selected, files on the card that have the same number as those in the DCP551 are left as they are and the next number file is selected for processing.

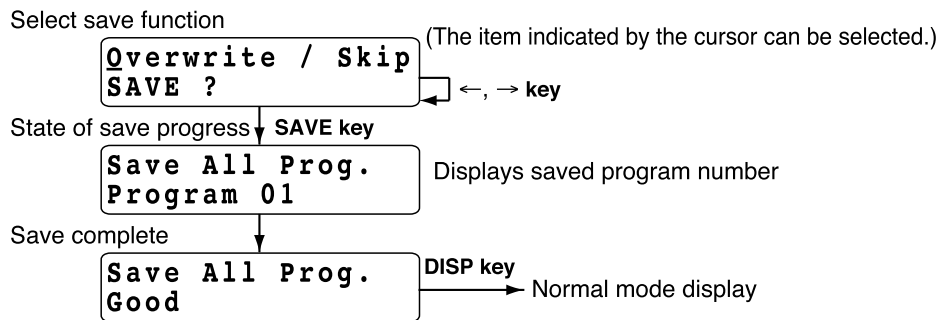

■ Procedures for saving setup data

This procedure saves the DCP551 setup data on a memory card.

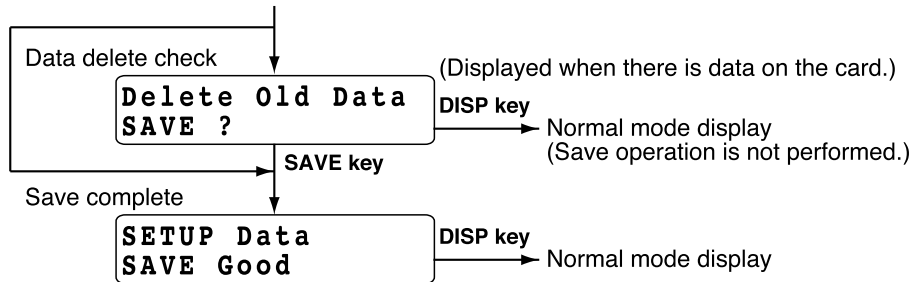

■ Procedures for saving variable parameters

This procedure saves the DCP551 variable parameter data on a memory card.

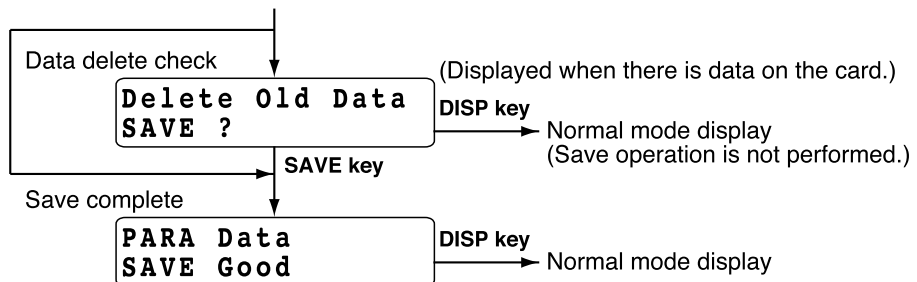

■ Procedures for saving PID parameters

This procedure saves PID parameters and constant value control data on a memory card.

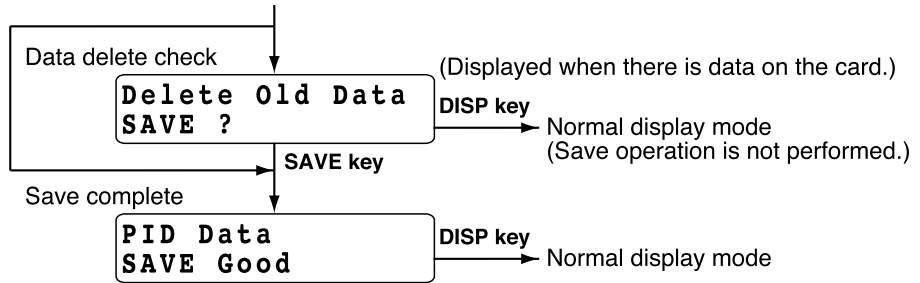

■ Procedures for saving event configuration data

This procedure saves event configuration data on a memory card.

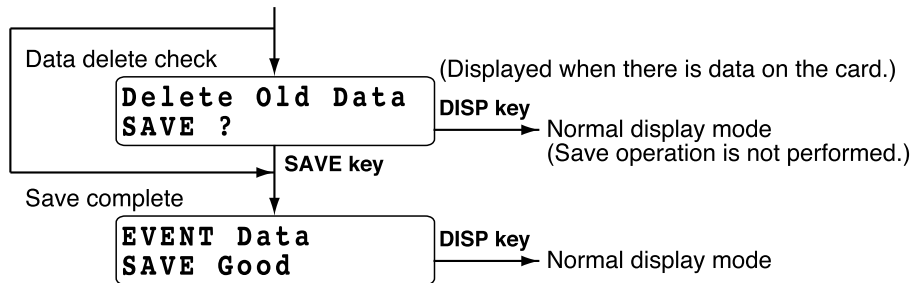

■ Procedures for saving all parameters

This procedure saves all parameters on a memory card.

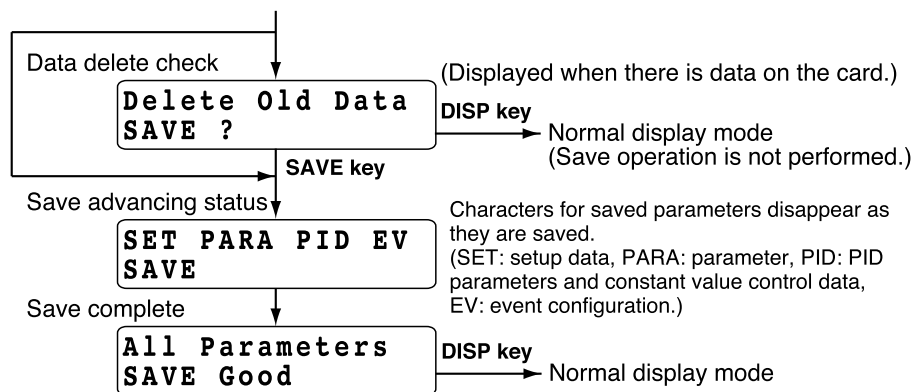

9-3 Load Procedures

Insert a memory card when the DCP551 is in the READY mode and the normal display mode, and variable parameter **PA05** has been set to 0. Press the **LOAD key** to start a load operation. “**Card**” is displayed in display panel 1 and “**Load**” is displayed in display panel 2. An error code appears if something should go wrong during the save operation.

■ Load menu

When the **LOAD key** is pressed in the normal display mode, the load menu panel is displayed. Use the **ENTER key** to select the desired menu.

Press the **ENTER key** to display the desired menu in the message display panel. The **DISP key** returns you to the normal display mode.

Note, however, that an autoload operation is performed when the **LOAD key** is pressed and variable parameter **PA05** is set to 1.

For details, see “**Section 9-4 Autoload**” (page 9-10).

A RAM memory card whose internal batteries are too low, cause a card battery alarm panel to be displayed before the Load menu panel is displayed.

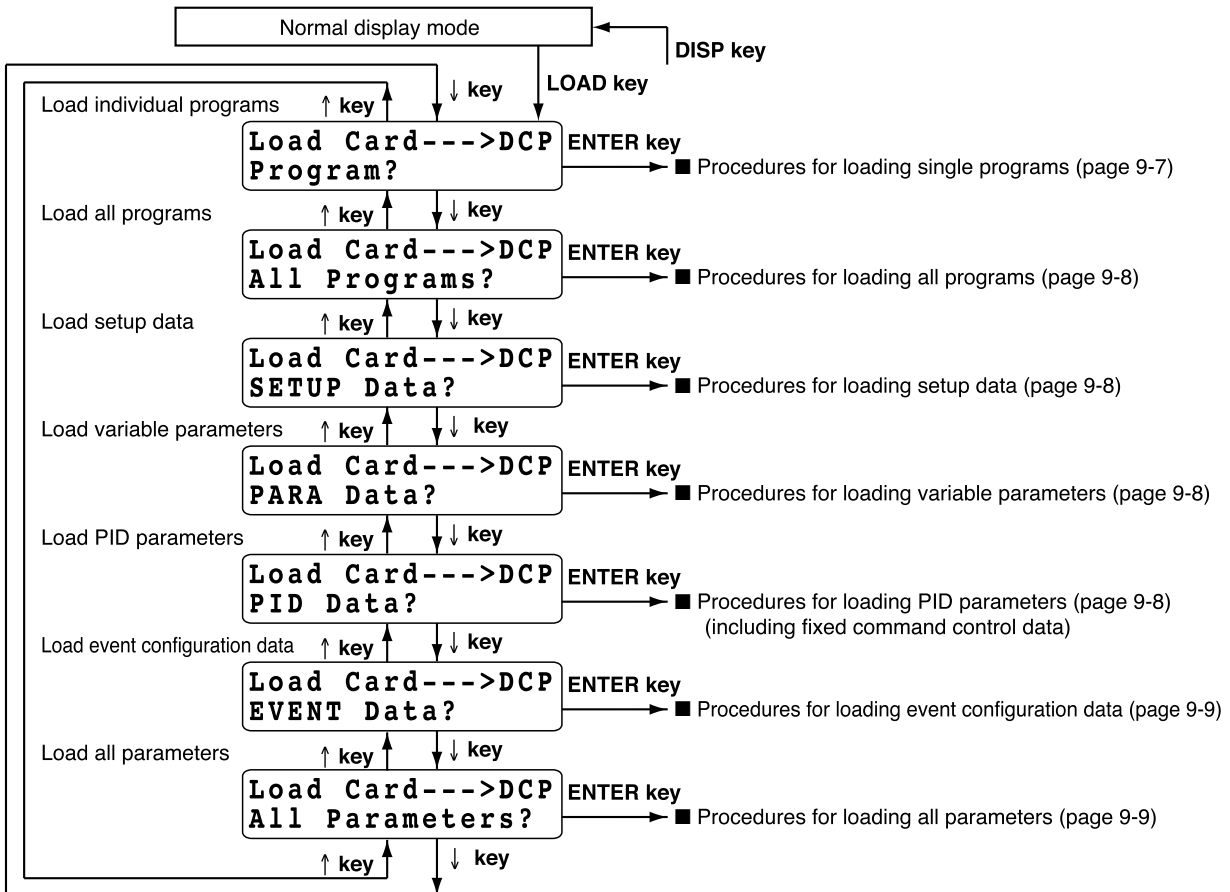

■ Card battery alarm panel

When the voltage of the internal battery in a RAM card is too low, the data saved on the disk may be corrupted. Loading corrupted data onto the DCP551 will cause maloperation. Do not use a card whose battery voltage is too low. If you want to load the data anyway, select “Ignore” in this panel and press the **ENTER key**. This displays the load menu. To return to the normal display mode, select “Quit” or press the **ENTER key** or the **DISP key**.

Card battery alarm screen

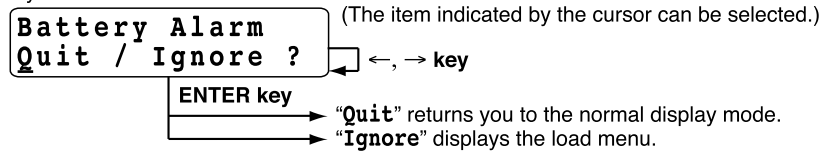

■ Procedures for loading individual programs

This procedure loads single memory card files on the DCP551.

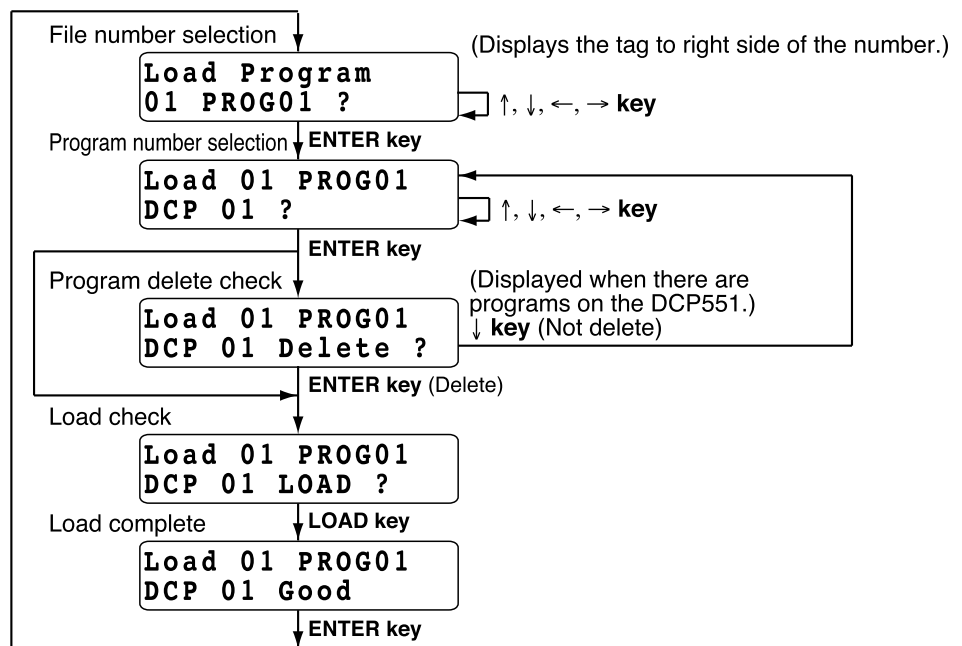

■ Procedures for loading all programs

This procedure loads all programs on the memory card in the DCP551. The file numbers used on the memory card are converted to file numbers used in the DCP551.

When the “Overwrite” load function is selected, programs in the DCP551 that have the same number as those on the card are overwritten by the card programs.

When the “Skip” load function is selected, programs in the DCP551 that have the same number as those on the card are left as they are and the next number is selected for processing.

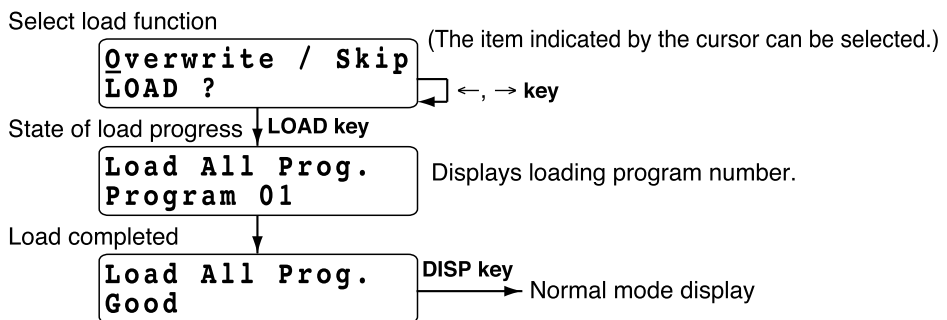

■ Procedures for loading setup data

This procedure loads setup data on the memory card onto the DCP551.

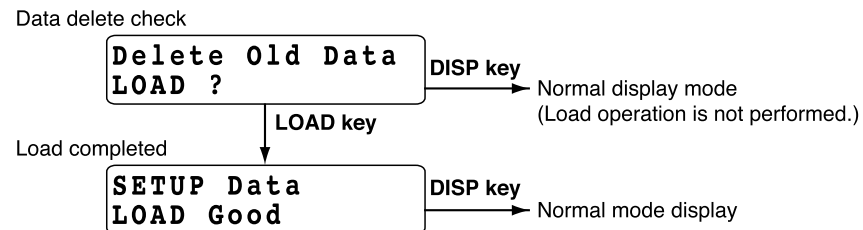

■ Procedures for loading variable parameters

This procedure loads variable parameters on the memory card onto the DCP551.

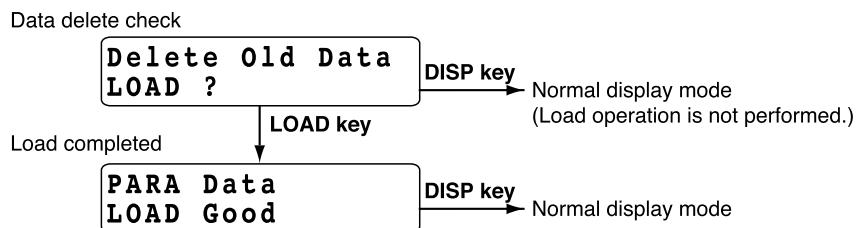

■ Procedures for loading PID parameters

This procedure loads PID parameters and constant value control data on the memory card onto the DCP551.

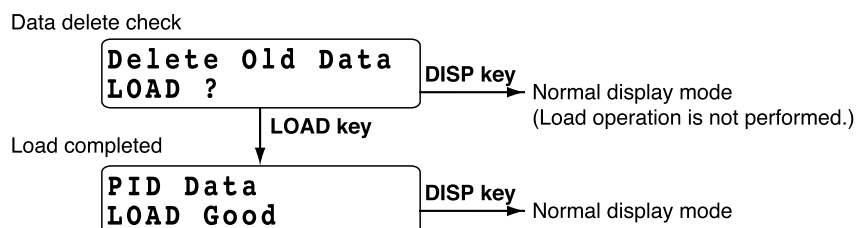

■ Procedures for loading event configuration data

This procedure loads event configuration data on the memory card onto the DCP551.

Data delete check



Load completed



■ Procedures for loading all parameters

This procedure loads all parameters on the memory card onto the DCP551.

Data delete check



Load completed



! HANDLING PRECAUTIONS

The DCP551 Mark II and the old model, DCP551, differ in how some setup data items are processed and the range of variable parameter **PA15**. Thus the following changes have to be made when setup data, variable parameters or all parameters saved on a DCP551 are loaded onto a DCP551 Mark II.

- Setup data : **C21, C45 to C50, C52, C53, C80, C90 to C97**
- Variable parameters: **PA15**

Setup data and all parameters stored on a DCP551 Mark II cannot be loaded onto a DCP551. (A loading attempt generates card error 16.)

9-4 Autoload

Insert a memory card, press the **LOAD key** or use external switch inputs in the READY mode and the normal display mode to load file number 1 on the memory card as program 1 onto the DCP551.

■ Key operated autoload procedure

● Conditions

Memory card : Program has been saved to file number 1
Variable parameter : **PA05** set to 1
Mode : READY mode, normal display mode

● Operation and action

Insert a memory card and press the **LOAD key**.

The DCP551 operates as follows.

- “**AUTO**” is displayed in display panel 1 and “**LOAD**” is displayed in display panel 1.
- When program number 1 has been loaded onto the DCP551, program number 1 disappears.
- File number 1 on a memory card is loaded onto the DCP551 as program number 1.
- When a load operation is successful, the “**AUTO**” and “**LOAD**” indications go off and the normal display mode appears.

Unless the number of a program is selected using external switch inputs, program 1 in segment 1 is selected.

- If the load operation fails, the “**AUTO**” and “**LOAD**” indications stay on and an error code is displayed in the message panel.

When an error has occurred, press the **DISP key** to return to the normal display mode.

❗ HANDLING PRECAUTIONS

A normal load operation cannot be performed when variable parameter **PA05** is set to 1. A normal load operation requires that this parameter is set to 0.

■ Auto load using external switch inputs

● Conditions

Memory card : Program saved to file number 1
 Setup data : any of **C71** to **C74** is set to 8 (autoload)
 Mode : READY mode, normal display mode

● Operation and action

Insert a memory card and turn off the external switch used for autoload and turn it back on again.

The DCP551 operates as follows.

- “**AUTO**” is displayed in display panel 1 and “**LOAD**” is displayed in display panel 2.
- When program number 1 has been loaded onto the DCP551, program number 1 disappears.
- File number 1 on a memory card is loaded onto the DCP551 as program number 1.
- When a load operation is successful, the “**AUTO**” and “**LOAD**” indications go off and the normal display mode appears.

Unless the number of a program is selected using external switch inputs, program 1 in segment 1 is selected.

- If the load operation fails, the “**AUTO**” and “**LOAD**” indications stay on and an error code is displayed in the message panel.

When an error has occurred, press the **DISP key** to return to the normal display mode.

! HANDLING PRECAUTIONS

Variable parameter **PA05** can be set to 1 or 0.

9-5 Error Message List

When an error occurs, error messages such as “Card Error-XX” (XX denotes error code) are displayed on the message panel during memory card operations. The table below lists the error codes and explain their meaning. Memory card operations are aborted when an error occurs.

To return to the normal display mode, press the **DISP** key.

Code	Meaning	Remedial measures
1	Card insertion failure or card removed	Do over.
2	Card write protect	Replace the card, or reset the protect by SLP550.
3	Card read protect	Replace the card, or reset the protect by SLP550.
4	Bad card	Replace the card.
5	Invalid card format	Initialize the card.
6	Card full	Erase unnecessary files, or initialize the card.
7	Card busy	Do over.
8	File write protect	Initialize the card.
9	Card access error	Do over.
11	Card access sequence error	Do over.
12	FAT abnormal	Initialize the card.
14	Card access sequence error (in file control)	Do over.
15	Card battery voltage drop (warning)	Replace the card, replace the card battery (If replaceable).
16	Wrong file version	Create new file, and create new data.
17	Data or file are missing.	Create new file, and create new data.
18	DCP551 data full (program load)	Delete unnecessary programs in the DCP551.
19	DCP551 hardware error (load error)	Do over.
20	Card data invalid	Do over.
21	Card data check sum error (program data)	Operate the instrument again, or check the program setting of the DCP551.
22 to 36	Card data check sum error (parameter data)	Operate the instrument again, or check the parameter setting of the DCP551.
37	Memory protect error (loading the data is protected by the variable parameter PA02 .)	Set DCP551 variable parameter PA02 to 0 to cancel protection.
43	No alternate areas remain on the EEPROM card	Replace the card.
44	Error occurred in writing to alternate area on EEPROM card	Replace the card.
63	Card battery voltage drop (error)	Replace the card, replace the card battery (If replaceable).
64	File abnormal (card was removed)	Create new file, and create new data.

Chapter 10. TROUBLESHOOTING

10-1 Self-Diagnostic Functions and Alarm Code Displays

The DCP551 is equipped with the self-diagnostic functions described below. Alarm codes and the result of self-diagnostics are listed on the following pages.

■ Power ON self-diagnostic routines

● RAM backup failures

This routine is designed to detect errors in the RAM backup function. When a failure is detected, a general reset is performed. No alarm code is displayed.

● Board configuration failures

This routine detects failures caused when boards (circuit boards) not designed to be used with the DCP551. Alarm codes are displayed when errors are detected.

■ Self-diagnostic routines performed each sampling cycle

● Analog input failures

Failures are detected when the analog input signal due to disconnection or other cause lies outside the -10.0 to $+110.0\%$ range.

Alarm codes are displayed when errors are detected.

■ Self-diagnostic routines performed continuously during operation

● PROM failures

This routine is designed to detect errors in system programs stored in the PROM. Not totally infallible, there are cases where errors go undetected and result in measuring device operation failure.

Alarm codes are displayed when errors are detected.

● Adjustment data failures

This routine detects errors in analog inputs and output adjustment data stored in non-volatile memory. Alarm codes are displayed when errors are detected.

● Program failures

This routine detects failures in program setting data stored in a backup RAM. Alarm codes are displayed when errors are detected..

● Parameter failures

This routine detects failures in parameters stored in a backup RAM. Alarm codes are displayed when errors are detected.

● Low battery voltage

This routine detects low voltage conditions in the battery that backups RAM data. The BAT LED on the console goes on when battery voltage is too low.

■ Alarm code display

The DCP551 is designed to alternate display of the following alarm codes and normal display items in one-second intervals on display panel 1 when input failures or instrument system failures are detected.

In cases of multiple alarm codes, display of the codes is alternated with normal display items, starting in order from the alarm code with the smallest number.

■ Alarm classification

PV range alarm group : **AL01** to **AL04**

Measuring instrument alarm group : **AL90** to **AL99**, and battery voltage drop
(In case of battery voltage drop, BAT LED of the console is flickered.)

Alarm code	Alarm name	Contents	Countermeasure
AL01	PV1 overrange	PV1 is more than 110%FS.	Check PV1.
AL02	PV1 underrange	PV1 is less than -10%FS.	
AL03	PV2 overrange	PV2 is more than 110%FS.	Check PV2
AL04	PV2 underrange	PV2 is less than -10%FS.	
AL90	Board configuration failure	Incorrect board configuration	Request the repair.
AL92	Adjustment value is abnormal.	Analog input/output adjustment data were broken.	Request the repair.
AL93	Setup data is abnormal.	Setup data were broken.	Check the setup data, and reset the data.
AL94	Variable parameter is abnormal.	Variable parameter were broken.	Check the variable parameter, and reset the data.
AL95	PID parameter is abnormal. (Constant value control data is abnormal.)	PID parameter were broken.	Check the PID parameter, and reset the data.
AL96	Program data is abnormal.	Program data were broken.	Check the program data, and reset the data.
AL97	Event configuration data is abnormal.	Event configuration data were broken.	Check the event configuration data, and reset the data.
AL99	PROM is abnormal.	System program were corrupted.	Request the repair.

*1: When **AL90** is generated, the alarm code stays on and continued operation is disabled.

*2: Data checks performed by **AL93** and **AL97** may fail to detect corrupted data. When this happens, the alarm can be turned off by entering normal data.

10-2 Key Input Related Problems

Procedures to correct key input related problems are described below.

■ Normal display mode problems

● Mode cannot be changed using keys

Cause	Measure
Normal display mode not on	Press DISP key to invoke normal display mode.

● Program number does not start flashing when PROG key is pressed

Cause	Measure
Program selection of external switch input is not 0.	Turn off all external switch inputs SW9 to 16.
Not set to READY mode.	Set READY mode to execute RESET operation (PROG + RUN/HOLD keys).
Set to constant value control mode.	Set constant value control data <i>Const</i> setting to 0.
Set to key lock.	Set variable parameter <i>PA01</i> between 0 to 2.

● RUN mode cannot be invoked with the RUN/HOLD key

Cause	Measure
Program selected in READY mode is unset.	Select the set program.
Set to END mode.	Set READY mode to execute RESET operation (PROG + RUN/HOLD keys).
Set to key lock.	Set variable parameter <i>PA01</i> between 0 to 2.

● HOLD mode cannot be invoked with the RUN/HOLD key

Cause	Measure
Set to READY or FAST mode.	The HOLD mode is available from READY and FAST modes by pressing the RUN key . Press the RUN/HOLD key once again.
Set to END mode.	Perform a reset operation (press the PROG, RUN and HOLD keys). Invoke the READY mode and perform a RUN operation (press the RUN/HOLD key) to go to the RUN mode.
Set to constant value control mode.	Set constant value control data <i>Const</i> to 0.
Set to key lock.	Set variable parameter <i>PA01</i> between 0 to 2.

● RESET cannot be performed with the PROG, RUN and HOLD keys.

RESET is available in the READY program run mode and returns operations to the first segment.

Cause	Measure
Set to READY mode.	Perform a RUN operation (press the RUN/HOLD key) to go to the RUN mode. (A reset operation can also be performed in the READY mode using external switch inputs or transmission.)
Set to key lock.	Set variable parameter <i>PA01</i> between 0 to 2.

● **ADV cannot be invoked with PROG and DISP keys**

Cause	Measure
Set to READY mode.	Perform a RUN operation (press the RUN/HOLD key) to go to the RUN mode. (ADV operation can be performed in the READY mode with external switches or through transmission.)
Set to END mode.	Perform a reset operation (press the PROG, RUN and HOLD keys). Invoke the READY mode and perform a RUN operation (press the RUN/HOLD key) to go to the RUN mode.
Set to constant value control mode.	Set constant value control data <i>ConSt</i> setting to 0.
Set to key lock.	Set variable parameter <i>PA01</i> between 0 to 2.

● **FAST mode cannot be invoked with FUNC and → keys**

Cause	Measure
Set to program time unit as 0.1 sec.	Set 0 or 1 setup data <i>C62</i> setting.
Set to END mode.	Perform a reset operation (press the PROG, RUN and HOLD keys). Invoke the READY mode and perform a RUN operation (press the RUN/HOLD key) to go to the RUN mode.
Set to constant value control mode.	Set constant value control data <i>ConSt</i> setting to 0.
Set to key lock.	Set variable parameter <i>PA01</i> between 0 to 2.

● **MANUAL mode cannot be invoked with A/M key**

Cause	Measure
On-off control is set in <i>P</i> setting = 0.0.	Set the <i>P</i> setting for a currently used PID group to something other than 0.0 to switch from ON-OFF control to PID control.
On-off control is set with segment PID group number = on-off.	Set the segment PID group number between 1 to 9 or to A to switch to PID control.
Set to key lock.	Set variable parameter <i>PA01</i> between 0 to 2.

● **AUTO mode cannot be invoked with A/M key**

Cause	Measure
Set to key lock.	Set variable parameter <i>PA01</i> between 0 to 2.

● **Autotuning (AT) cannot be started with AT key**

Cause	Measure
Set to READY mode. (With variable parameter <i>PA08</i> setting = 1 or 2)	Set RUN mode to execute RUN operation (RUN/HOLD key).
Set to except READY mode. (With variable parameter <i>PA08</i> setting = 3 or 4)	Set READY mode to execute RESET operation (PROG + RUN/HOLD keys).
Set to MANUAL mode.	Set AUTO mode to execute AUTO operation (A/M key).
PV overrange.	Connect PV input correctly to obtain normal input conditions.
AT is set to off	Set variable parameter <i>PA08</i> to something other than 0.
Set to setting instrument (programmer) function.	Set setup data <i>C21</i> to something other than 0.
Set to key lock.	Set variable parameter <i>PA01</i> between 0 to 2.

● Autotuning cannot be canceled with AT key

Cause	Measure
Set to key lock.	Set variable parameter <i>PA01</i> between 0 to 2.

● PID parameter setting state cannot be invoked with PID key

● Event configuration setting state cannot be invoked with FUNC and PARA keys

Cause	Measure
Normal display mode not on	Press DISP key to invoke normal display mode.
Set to key lock.	Set variable parameter <i>PA01</i> to 0 or 2.

● Setup data setting state cannot be invoked with SETUP key

Cause	Measure
Normal display mode not on	Press DISP key to invoke normal display mode.
Mode other than READY	Set READY mode to execute RESET operation (PROG + RUN/HOLD keys).
Set to key lock.	Set variable parameter <i>PA01</i> between 0 to 2.

● Constant value control data setting state cannot be invoked with FUNC and PID keys

Cause	Measure
Normal display mode not on	Press DISP key to invoke normal display mode.
Mode other than READY	Set READY mode to execute RESET operation (PROG + RUN/HOLD keys).
Set to key lock.	Set variable parameter <i>PA01</i> between 0 to 2.

● Program setting state cannot be invoked with FUNC and PROG keys

Cause	Measure
Normal display mode not on	Press DISP key to invoke normal display mode.
Set to constant value control mode.	Set constant value control data <i>Const</i> setting to 0.
Set to key lock.	Set variable parameter <i>PA01</i> between 0 to 2.

● Program copy cannot be performed with ↑ and PROG keys

Cause	Measure
Mode other than READY	Press DISP key to invoke normal display mode.
Set to be except READY mode.	Set READY mode to execute RESET operation (PROG + RUN/HOLD keys).
Program selected in READY mode is unset.	Select number of a set program.
Constant value control mode is on.	Set constant value control data <i>Const</i> to 0.
Program protected	Set variable parameter <i>PA02</i> to 0, 2 or 4.
Set to key lock.	Set variable parameter <i>PA01</i> to 0.

● General reset cannot be performed with **FUNC**, **CLR** and **MESSAGE** keys

Cause	Measure
Normal display mode not on	Press DISP key to invoke normal display mode.
Mode other than READY mode	Set READY mode to execute RESET operation (PROG + RUN/HOLD keys).
Set to MANUAL mode.	Set AUTO mode to execute AUTO operation (A/M key).
Set to memory protect.	Set variable parameter PA02 to 0.
Set to key lock.	Set variable parameter PA01 to 0.

■ Parameter setting related problems

● Registration state cannot be invoked with **ENTER** key

Cause	Measure
"-----" displayed in display panel 2	This item cannot be displayed or set. To change setting connection item, it may be able to change or set.
Data displayed in display panel 2 cannot be changed.	This item is display only.
Set to memory protect.	Set variable parameter PA02 to 0.

■ Program setting related problems

● Registration state cannot be invoked with **ENTER** key

Cause	Measure
Set to memory protect.	Set variable parameter PA02 to 0, 2 or 4.

● Item changes cannot be made with **↑** and **↓** keys

Cause	Measure
Not pattern item set.	Set SP and time data.

● SP values in program settings cannot be changed with **↑** and **↓** keys

Cause	Measure
SP limit sets error value.	Set correct value for setup data C66 and C67 .

● Event items cannot be displayed with **↑** and **↓** keys

Cause	Measure
Event type is something other than segment type.	Set the event type in the event configuration data to a value between 1 and 23.
Programming item sets no display.	Set setup data C57 to 0.

● **PID group, output limiter group number items cannot be displayed with ↑ and ↓ keys**

Cause	Measure
Programmer function on	Set setup data <i>C21</i> to something other than 0.
Programming item display off	Set setup data <i>C58</i> to 0.

● **G.SOAK items, PV shift items and repeat items cannot be displayed with ↑ and ↓ keys**

Cause	Measure
Programming item display off	Set setup data <i>C59</i> to 0.

● **PV start items, cycle items and pattern link items cannot be displayed with ↑ and ↓ keys**

Cause	Measure
Programming item display off	Set setup data <i>C60</i> to 0.

● **Segment insertion and deletion cannot be confirmed with FUNC and ENTER keys**

Cause	Measure
Set to memory protect.	Set variable parameter <i>PA02</i> to 0, 2 or 4.
Program being set is running (in RUN, HOLD, FAST, END, READY FAST).	Set READY mode to execute RESET operation (PROG + RUN/HOLD keys).
Not set to pattern item on programming map.	Move to the pattern item on the programming map.
This segment is not set on the programming map.	Move to a set segment or set the segment.

● **Program deletion cannot be confirmed with FUNC and ENTER keys during pattern item registration**

Cause	Measure
Program being set is running (in RUN, HOLD, FAST, END, READY FAST).	Set READY mode to execute RESET operation (PROG + RUN/HOLD keys).

10-3 When the BAT LED Flashes

HANDLING PRECAUTIONS

Batteries that have been stored for long periods have been subject to self-discharge and have a short service life. If required, buy new batteries.

■ BAT LED flashes

The BAT LED starts flashing when low battery voltage is detected. The voltage level set in memory that trigger the LED is higher than minimum level required for storing data. Thus data loss is thus not imminent when the LED starts flashing.

Note, however, that memory data corruption has probably occurred when the BAT LED starts flashing at power up after the DCP551 has been stored for long periods disconnected from the power line.

■ Replacing the battery

Parameter settings and program settings are stored in RAM memory. The RAM is backed up by a battery and data persist through a power down. When the battery is depleted, turning off the DCP551 causes the data stored in RAM to be lost.

CAUTION



Be sure to turn off the power supply when you are replacing the batteries. Failure to heed this warning may lead to electric shock.



Be sure not to touch internal components during battery replacement or just after the power has been turned. This may result in burn injuries.



- Make sure that the batteries are inserted with the plus (+) and minus (-) poles correctly oriented.
- Do not use damaged batteries or batteries that leak.
- Do not throw batteries into a fire, recharge, disassemble or expose them to heat.
- Store batteries in a cool, dry place.

Failure to heed these cautions may result in burns or battery leakage.



Batteries should be kept out of reach of children, since they may swallow them. Should a child swallow a battery, contact a doctor immediately.



When disposing of used batteries at the user site, observe local bylaws.



Before you touch internal components, be sure to discharge any static electricity on your body by touching a metal ground connector. Failure to heed this caution may lead to equipment damage.

● Items to be provided by the user

- Phillips screwdriver
- New lithium battery: model number 81446140-001

● Battery replacement procedures**! HANDLING PRECAUTIONS**

- Replace the old battery with a lithium battery (model no.:81446140-001). Batteries can be ordered from Honeywell sales or service office.
- Do not use metal tools to remove or attach battery connectors as this could short-circuit electric circuits inside.
- A capacitor backs up the memory during battery replacement. To charge this capacitor, supply power to the **DCP551** for about 10 minutes. Replace the battery less than 24 hours after the power supply has been turned off.

When the **BAT** LED starts flashing, replace the battery according to the following instructions.

- (1) Leave the power on for about 10 minutes.
- (2) Turn off the power.
- (3) Open the console key cover and remove the lock screw under the **ENTER** key using a Phillips screwdriver.
>>Slide the controller out of the case.

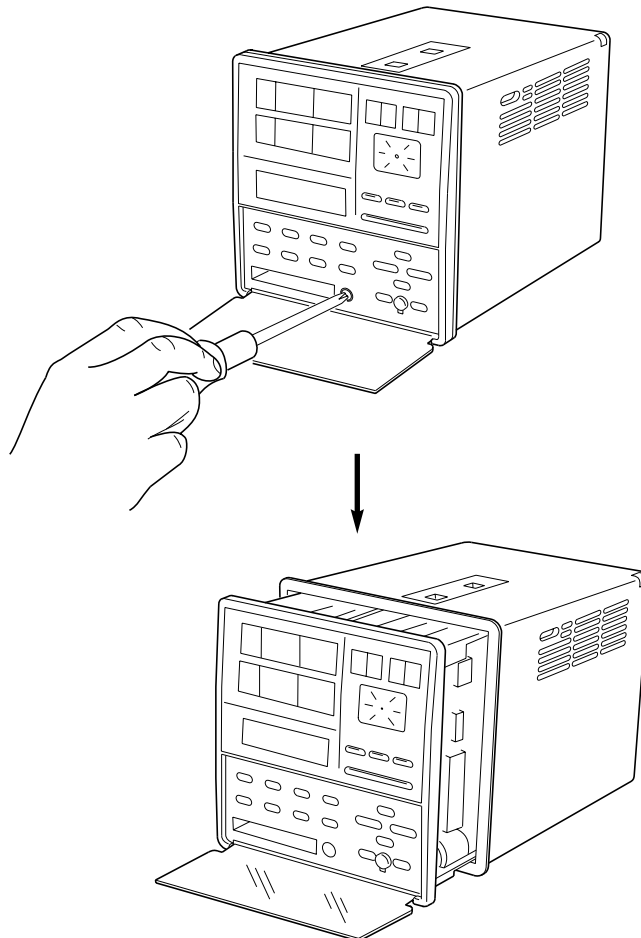

- (4) To prevent static discharges, remove all static electricity from your body.
- (5) Slide the controller completely out of the case.
 - >>The battery is located on the right side as seen from the front of the controller.

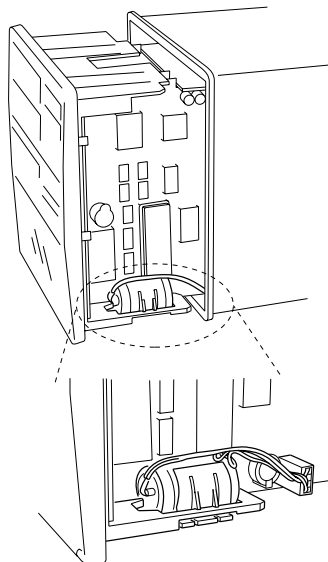

- (6) Place the controller on a desk upside-down so that the battery is easily accessible.
- (7) Disconnect the connectors.
- (8) Open the tab on the black clip that secures the battery and lift out the battery.

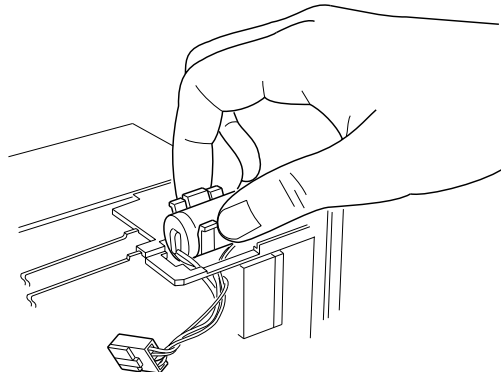

- (9) Remove the old battery from the clip.
- (10) Insert the new battery in the clip.
- (11) Orient the positive pole of the battery forwards and press the clip with the battery into the square opening.
- (12) Insert the connectors in the printed circuit board.
- (13) Slide the controller back into the case.
- (14) Open the key cover and firmly tighten the lock screw under the **ENTER key** using a Phillips screwdriver.
- (15) When all procedures have been completed, affix a label giving the date when the battery should be replaced next time in an easy to see location on the controller.
- (16) Turn on the power to make sure that the **BAT LED** does not go on.

**NOTE**

- Guidelines for battery service life are given below.
When the DCP551 is stored with the power off under standard conditions (ambient temperature $23\pm 2^{\circ}\text{C}$): 5 years
When the DCP551 is stored with the power on under standard conditions (ambient temperature $23\pm 2^{\circ}\text{C}$): 10 years
Battery life is reduced when stored at higher temperatures.
- When the BAT LED is flashing, memory data is protected if the power is on.
- When the data in memory is corrupted, one of the following two conditions will occur.
 - (1) “**g.rEst**” is displayed at power up and normal operation cannot be performed.
(Press the **ENTER key** to perform a general reset and reset parameters to their factory default values and delete all program settings.
 - (2) Normal operation can be started at power up but one of the alarm codes **AL93** to **AL97** are displayed.

Chapter 11. SPECIFICATIONS

11-1 Specifications

	Item	Specifications
Program section	No. of programs	99 programs
	No. of segments	99 segments/1 program, or total 2000 segments
	Segment setting system	RAMP-X: Setting by set points (SP) and time. RAMP-T: Setting by set points (SP) and slope (θ). RAMP-E: Setting by set points (SP) or Δ SP per pulse of external switch input.
	Segment time	0 to 500 hours 00 min, 0 to 500 min 00sec, or 0.0 to 3000.0sec (Time unit is switchable.)
	Segment slope	1 to 10000U/hours, 1 to 10000U/min, or 1 to 10000U/sec (Time unit is switchable.)
	Segment Δ SP	1 to 10000U/1 pulse
	No. of sub-function	4000 settings
	Sub-function function	Event, PID group, output limiter group, G.SOAK, PV shift, repeat
	Event (16 point)	Operating point set as specified by event type.
	PID group setting	Group 0 (continuing from previous segment), groups 1 to 9, group A (automatic changeover) and ON-OFF control settable.
	Output limiter group	Group 0 (continuing from previous segment), groups 1 to 9 settable
	G.SOAK	Type (start point, end point, all) and G.SOAK width 0 to 1000U settable
	PV shift	-10000 to +10000 settable
	Repeat	Return segment number and repeat count settable.
	PV start	Type settable for each program (ascending, descending and bi-directional)
	Cycle	Cycle count number settable for each program
	Pattern link	Program numbers 0 to 99 (program 0 without link) settable for each program
	Tag	8 characters consisting of alphanumerics, katakana and symbols settable for each program
	Basic time accuracy	$\pm 0.01\%$ (segment time setting = 0, repeat; each cycle and repeat slows the process by 0.1sec)
Input section	Input type	Multi-range of thermocouple, resistance temperature detector, DC voltage, and DC current (see page 2-8.)
	Input sampling cycle	0.1s
	Input bias current	Thermocouple, DC voltage input: Max. $\pm 1.3\mu\text{A}$ (peak value, under standard conditions). The range higher than 1V is Max. $-3\mu\text{A}$.
	Input impedance	DC current input: approx. 50Ω (under operating conditions)
	Measurement current	RTD input: approx. 1mA, Current input on terminal A. (under operating conditions)
	Influence of wiring resistance	Thermocouple, DC voltage input: Thermocouple : $0.5\mu\text{V}/\Omega$ DC voltage (lower than 1V range) : $0.5\mu\text{V}/\Omega$ DC voltage (5V range) : $3\mu\text{V}/\Omega$ DC voltage (10V range) : $6\mu\text{V}/\Omega$ Resistance temperature detector input: Max. $\pm 0.01\%$ FS/ Ω within wire resistor 0 to 10W The ranges of F01, F33, P01, and P33 are Max. $\pm 0.02\%$ FS/ Ω .
	Resistance temperature detector input	<ul style="list-style-type: none"> The ranges except F01, F33, P01, and P33 are lower than 85Ω. (Includes the zener barrier resistor value. However, spot adjustment is needed.) The ranges of F01, F33, P01, and P33 are lower than 10Ω.
	Allowable parallel resistance	Thermocouple disconnection detection allowable parallel resistance : Higher than $1\text{M}\Omega$
	Max. allowable input	Thermocouple, DC voltage input: -5 to $+15\text{Vdc}$ DC current input : 50mAdc , 2.5Vdc
	Burn out	Burnout on/off selectable
	Range over assessment	100% FS or more: upscaled -10% FS or less : downscaled (However, inputs in the F50 range are not downscaled.)
	Cold junction compensation accuracy	$\pm 0.5^\circ\text{C}$ (under standard conditions)

Item		Specifications
Input section	Cold junction compensation system	Internal or external compensation (at 0°C) selectable
	Scaling	-19999 to +20000U (Only linear input can sets. Reverse scaling and optional decimal point position can set.)
	Root extraction	Drop out 0.2 to 10.0%. It is possible to set DC current and DC voltage range.
	PV equalizer (linearization)	PV1: 9 broken line (setting to 10 point) PV2: 19 broken line (setting to 20 point)
	Input bias	-1000 to +1000U variable
	Digital filter	0.0 to 120.0sec variable (0.0: Filter off)
External switch input section	Number of input point	16 points
	Connectable output type	No-voltage contact (relay contact), and open corrector (sink current toward 0V)
	Open terminal voltage	8.5V ± 0.5V during common terminal ((12) and (40) terminals) and every input terminal (under operating conditions)
	Terminal current in case of short circuit	Current to run every terminal is about 6mA (under operating conditions)
	Allowable contact resistance (no-voltage contact)	On condition: Lower than 250Ω (under operating conditions) Off condition: Higher than 100 kΩ (under operating conditions)
	Allowable residual current (open collector ON)	Lower than 2V (under operating conditions)
	Leakage current (open collector OFF)	Lower than 0.1mA (under operating conditions)
	Allocation (fixed)	RUN, HOLD, RESET, ADV, program number
	Allocation (variable)	RAMP-E, FAST, AT, AUTO/MANUAL, G.SOAK reset, forward-reverse operation, auto load, PV1/2 selection
	Input sampling cycle	0.1s
	On detection Min. hold time	0.2s (program number is 0.4s)
Display and setting section	Display panel 1	Digital 5 digits, 7 segments, green color Indicates PV and other data on basic display status, indicates an item code on parameter setting status.
	Display panel 2	Digital 5 digits, 7 segments, orange color Indicates SP, output %, and other data on basic display status, indicates a set point of item on parameter setting status.
	Program number display	Digital 2 digits, 7 segments, green color Indicates a program number on basic display status.
	Segment number display	Digital 2 digits, 7 segments, green color Indicates a segment number on basic display status, indicates a item number on parameter setting status. Indicates an alarm code number when an alarm occurs.
	Message display panel	Indicates output graph, deviation graph, event status, program tag, and other data on basic display status, Indicates a reference message on parameter setting and program setting. Indicates a operation contents and operation result on memory card operation.
	Profile display	7 flat LED, orange color Indicates the rising, soaking, and falling tendencies of program pattern.
	Each status display	22 flat LED Mode : RUN, HLD, MAN, PRG (green color) Display contents: PV, SP, OUT, TM, CYC, SYN, DEV (green color) Battery voltage : BAT (red color) (flickers when the battery voltage has dropped.) Status : AT (green color) Event : EG1, EG2 (red color)
	Operating keys	18 rubber keys
	Loader connection port	1 (Using exclusive connection cable, stereo pin jack)

Item		Specifications		
Mode	Program run mode	READY	: Preparation state (control stop, select of program number is possible.)	
		RUN	: Advancing run state	
	HOLD	: Hold run state		
	FAST	: Fast feed run state		
Constant value control mode	Program run mode	END	: End point run state	
		READY FAST	: Preparation and the fast feed state	
	AUTO	: Automatic run state		
	MANUAL	: Manual run state (output is operatable to console)		
Control section	PID control	Proportional band (P)	0.0 to 1000.0% (0.0: On-off control)	
		Integral time (I)	0 to 3600s (0: PD control)	
		Derivative time (D)	0 to 1200s (0: PI control)	
		Manipulated variable limit	Low-limit : -5.0% to high-limit High-limit : Low-limit to +105.0%	
		Manual reset	0.0 to 100.0%	
		No. of PID groups	16 groups for program operation (9 segment specific and 7 automatic zone selecting)	
		PID groups selection	Segment specified, automatic zone selectable during program run	
		Manipulated variable change	0.1 to 110.0%/0.1s	
		Auto tuning	Automatic setting of PID value by limit cycle method	
		On-off control differential	0 to 1000U	
	Normal reverse operation selection	Selection is settable		
	Programmer function	Selection	Manipulated variable output is selectable to SP output	
		Scaling	Possible	
		Output resolution	1/10000	
Output section	Auxiliary output	Type	PV, SP, deviation, MV, PV1, PV2	
		Scaling	Possible	
	Current output (5G) Auxiliary output CH1, CH2	Output current	: 4 to 20mA dc	
		Allowable load resistance	: Lower than 600Ω(under operating conditions)	
	Output accuracy	: Lower than ± 0.1% FS (under the standard conditions)		
	Output resolution	: 1/10000		
	Max. output current	: 21.6mA dc		
	Min. output current	: 2.4mA dc		
	Output update cycle	: 0.1s		
	Open time terminal voltage	: Lower than 25V		

Item		Specifications			
Communi- cation	RS-485	Data length	8 bits		
		Isolation	All inputs and outputs except external switch inputs are completely isolated.		
	RS-485 communications can be performed by connecting to a computer equipped with an RS-485 interface.				
	RS-232C	Network	Point to point; (DCP551 provided with only slave node functionality.)		
		Information direction	Half-duplex		
		Sync. system	Start-stop sync.		
		Transmission system	Not-balanced type		
		Data line	Bit serial		
		Signal line	Transmit and receive 3 lines		
		Communication speed	1200, 2400, 4800, 9600 bps selectable		
		Communication distance	Max. 15 m		
		Others	Conforms to RS-232C standard		
		Character composition	11 bits/characters		
		Format	1 start bit, even parity, 1 stop bit or 1 start bit, no parity, 2 stop bits		
Data length	8 bits				
Isolation	All inputs and outputs except external switch inputs are completely isolated				
Memory card	Programs, PID, various parameters (SET UP, PARA, events) and other data can be saved or loaded using memory card (optional).				
	Save (SAVE)	Copies DCP551 data into a card			
	Load (LOAD)	Loads data from a card into the DCP551			
	Memory card (optional)				
	Model No.	Memory type	Capacity bytes	No. of programs	Battery exchange
	SKM008A	RAM	7.00K	Max. 20	Not provided
	SKM016A	RAM	14.50K	Max. 52	Not provided
	SKM064A	RAM	61.75K	Max. 99	Not provided
	SKM256C	RAM	251K	Max. 99	Provided
	SKM008E	EEPROM	7.00K	Max. 20	Not necessity
SKM032E	EEPROM	29.75K	Max. 99	Not necessity	
<ul style="list-style-type: none"> No. of bytes per program is $26 + (5 \times \text{No. of segments}) + (5 \times \text{No. of sub-functions})$ No. of bytes per parameters is as specified below. <ul style="list-style-type: none"> Setup data : 217 bytes Variable parameter : 257 bytes PID parameter + Fixed command control data : 291 bytes Event configuration data : 209 bytes 					
General specifications	Memory backup	Memory battery service life Battery backed up RAM DCP551 power off: approx. 5 years under standard conditions DCP551 power on: approx. 10 years under standard conditions			
	Rated power supply voltage	100 to 240V ac 50/60Hz			
	Power consumption	Lower than 25VA			
	Rush current when power supply turns on	Lower than 50A			

Item		Specifications	
General specifications	Action when power supply turns on	Reset time: 10ms max. (time until normal operation possible under normal operating conditions)	
	Service interruption dead time	Lower than 20ms (under the action conditions)	
	Insulation resistance	Higher than 50M Ω under 500Vdc megger between power supply terminal (39)or(40) and FG terminal ((52)or(53))	
	Withstand voltage	1500V AC 50/60Hz for 1min between power terminal and frame ground terminal Note: Primary and secondary sides are capacitive coupled inside the DCP551. Thus disconnect the ground wire from the secondary side terminal (for example, when using a grounded thermocouple) before performing a withstand voltage test. Failure to do so may result in equipment damage.	
	Standard conditions	Ambient temperature	23 \pm 2 $^{\circ}$ C
		Ambient humidity	60 \pm 5% RH
		Rated power supply voltage	105V ac 1%
		Power supply frequency	50 \pm 1Hz or 60 \pm 1Hz
		Vibration resistance	0m/s ²
		Shock resistance	0m/s ²
		Mounting angle	Reference plane (vertical) \pm 3
	Operating conditions	Ambient temperature range	0 to 50 $^{\circ}$ C (the ambient temperature at the bottom of the case when hermetically sealed inside case)
		Ambient humidity range	0 to 90% RH (non-condensing)
		Rated power supply voltage	105V ac
		Allowable power supply voltage	90 to 264V ac
		Power supply frequency	50 \pm 2Hz or 60 \pm 2Hz
		Vibration resistance	0 to 1.96m/s ²
		Shock resistance	0 to 9.80m/s ²
		Mounting angle	Reference plane (vertical) \pm 10
		Altitude	2000m max.
	Transportation and storage conditions	Ambient temperature range	-20 to 70 $^{\circ}$ C
		Ambient humidity range	10 to +95% RH (non-condensing)
		Vibration resistance	0 to 4.90m/s ² (10 to 60Hz in X, Y and Z directions, 2hours each)
		Shock resistance	0 to 490m/s ² (in vertical direction, 3 times)
		Package drop test	Drop height 60cm (Free drop at 1 corner, 3 edges, 6 faces)
	Terminal screw	M3.5 self-up screw	
Terminal screw tighten torque	0.78 to 0.98N-m		
Mask and case material	Mask : Multiron Case : Multiron		
Mask and case color	Musk : Dark gray (Munsell sign 5Y3.5/1) Case : Light gray		
Mounting	Panel flush-mount		
Mass	About 1.5kg		

■ Attachment/auxiliary devices list

	Article name	Model No.	Quantity
Standard attachment	Engineering unit indicator label		1
	Mounting bracket	81446044-001	1 group (2 pcs.)
	User's manual	EN11-6186	1
	Terminal cover	81446176-001	1
Auxiliary devices and others (Optional)	Soft dust-proof cover set	81446141-001	
	Lithium battery set	81446140-001	
	Memory card (RAM, battery not replaceable)	SKM008A SKM016A SKM064A	
	Memory card (RAM, battery replaceable)	SKM256C	
	Memory card (EEPROM, no battery required)	SKM008E SKM032E	

11-2 External Dimensions

■ DCP551

Unit : mm

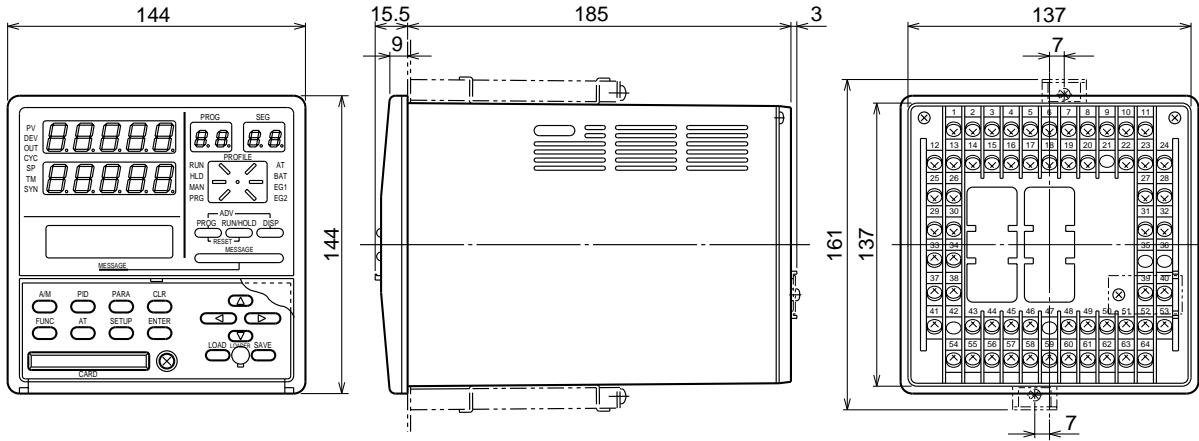

■ Soft dust-proof cover set (option) Model No. : 81446141-001 (silicon rubber, transparent)

Unit : mm

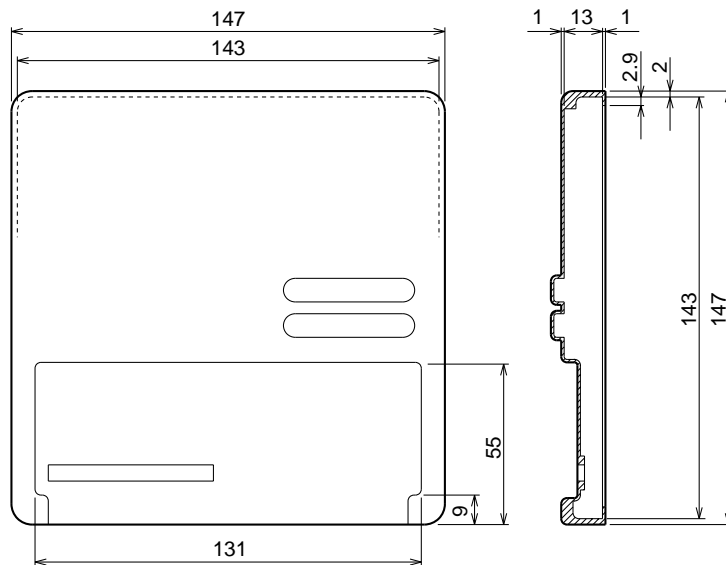

Chapter 12. CALIBRATION

This chapter covers the field calibrations procedures for the inputs, outputs and various functions of the DCP551 mark II controller after shipment from the factory. When calibration is made in the field, the original factory data is erased, and so the specified input/output accuracies of the controller cannot be assured. This manual is for users who are conversant with DCP551 mark II use and operation.

■ Precautions before calibration

Apply power and allow the controller to warm up for 2 hours before you calibrate the DCP551 mark II. Confirm that the test equipment needed for calibration has stabilized. Factory calibration has been made at a stable temperature of 23.0°C ($\pm 2^\circ\text{C}$). Calibrate the DCP551 mark II in this range, and where there are no significant fluctuations in air temperature.

You must write newly calibrated data to EEPROM before exiting from calibration mode, otherwise all new data will be lost.

If calibration equipment of a lower grade than specified below is used, calibration results may be unsatisfactory.

■ Equipment needed

1. Standard input source with $\pm 0.02\%$ accuracy (having more than 5 effective digits and capable of generating both voltage and current outputs)
2. Decade resistance box with $\pm 0.02\%$ accuracy (having a range of 10 to 300 Ω with a resolution of more than 0.01 Ω)
3. Digital ammeter with $\pm 0.02\%$ accuracy (measurable in the range of 4 to 20mA with assured resolution of more than 0.01mA)
4. Thermometer with $\pm 0.1^\circ\text{C}$ accuracy (resolution of more than 0.1 $^\circ\text{C}$)

12-1 Quick Reference Table for Calibration Items

DCP551 mark II controllers are numbered using the following format. Format items may require different calibration procedures, as shown in Table 12-1.

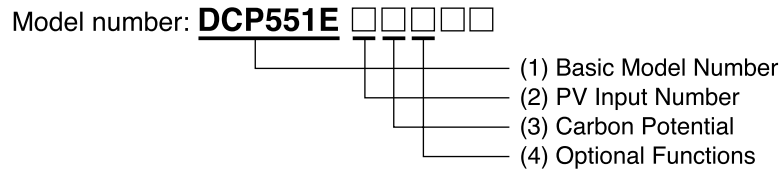

Table 12-1. Calibration Items for Each Model

Calibration & Test Item		Model	(1)Basic Model	(2)PV Input Number		(3)Carbon Potential		(4)Optional Functions		
				1	2	0	1	0	1	2
0	Function Test	Key Test	○							
		Indicator Test	○							
		DI Test	○							
		Control Output Test	○							
		DO Test	○							
		Clock Adjustment	○							
1	PV Input Calibration	Ch1		○	○					
		Ch2			○					
2	CJ Sensor Calibration	Ch1		○	○					
		Ch2			○*					
6	Current Output Calibration	Out Ch1	○							
		Out Ch2								
		AUX Ch1						○	○	
		AUX Ch2								○

Note: *; If this is Carbon Potential model (Carbon Potential Code = "1"), it isn't necessary to calibrate these items.

Table 12-2. Item and Sub Item Table for Calibration

Item	Sub Item	Description	Upper Display Shows	Lower Display Shows
0	0	Item change code	0000 , etc.	AdJS
	1	Key test		
	2	Display test		
	3	Digital input test		
	4	Output test (control)		
	5	Output test (digital output)		
	6	Clock adjustment		
1	0	Item change code	1011	
	1	Channel No.		
	2	Gain No.		
	3	PV input 0%		
	4	PV input 100%		
	5	Write to EEPROM	1111	
2	0	Item change code	2022	<div style="border-left: 1px solid black; border-right: 1px solid black; border-bottom: 1px solid black; padding: 5px; display: inline-block;"> Previous adjustment value </div>
	1	CJ ch1 input 0%		
	2	CJ ch1 input 100%		
	3	CJ ch1 count		
	4	CJ ch1 temperature		
	5	CJ ch2 input 0%		
	6	CJ ch2 input 100%		
	7	CJ ch2 count		
	8	CJ ch2 temperature		
	9	Write to EEPROM	1111	
6	0	Item change code	6066	<div style="border-left: 1px solid black; border-right: 1px solid black; border-bottom: 1px solid black; padding: 5px; display: inline-block;"> Previous adjustment value </div>
	1	OUT ch1 4mA output		
	2	OUT ch1 20mA output		
	3	OUT ch2 4mA output		
	4	OUT ch2 20mA output		
	5	AUX ch1 4mA output		
	6	AUX ch1 20mA output		
	7	AUX ch2 4mA output		
	8	AUX ch2 20mA output		
	9	Write to EEPROM	1111	

- Notes:**
1. Items No. is shown on the PROG display.
 2. Sub item No. is shown on the SEG display.
 3. Item 0: Function check item except sub item No. 6
 4. Items 1, 2, 6 and clock adjustment of item No. 0. : Calibration items

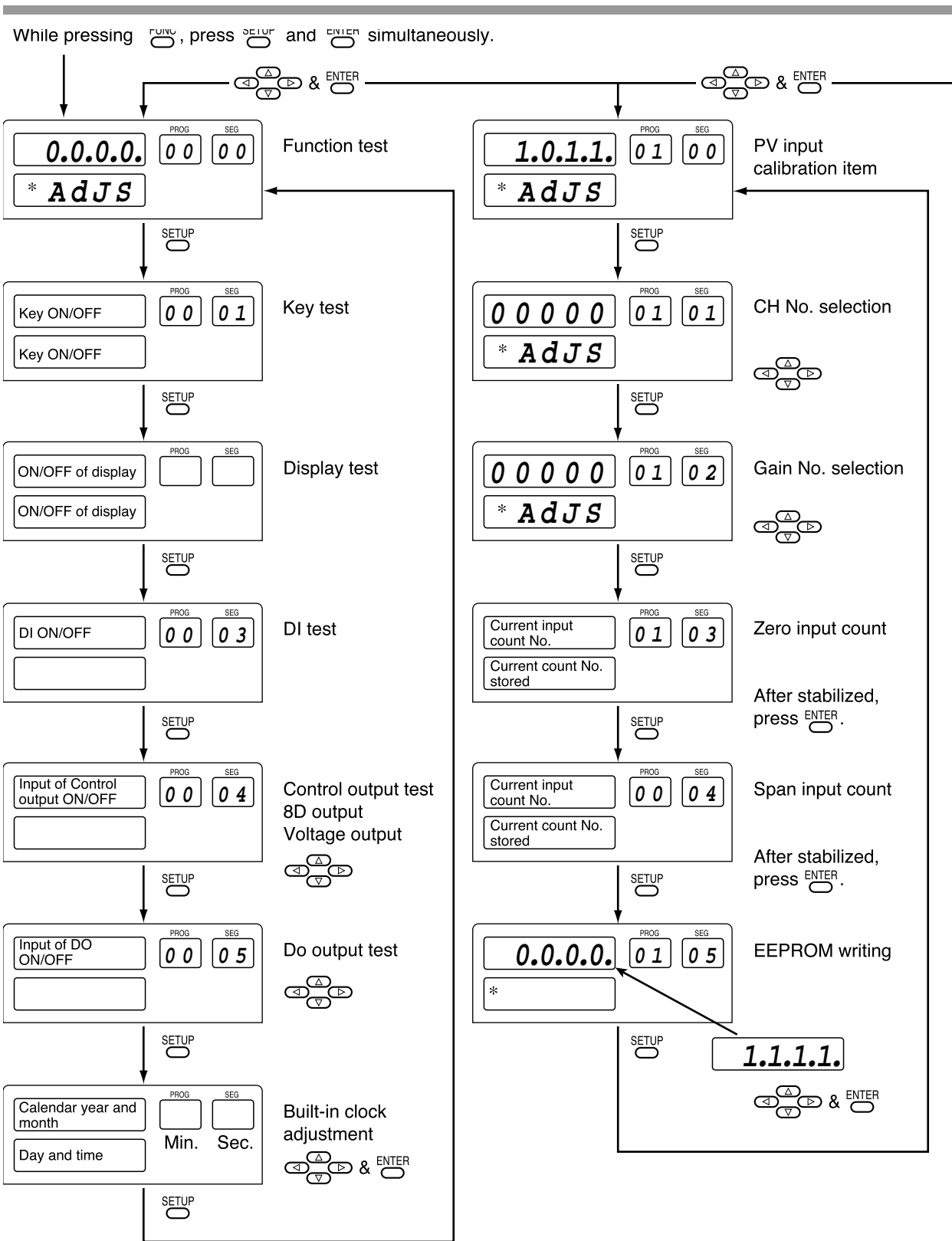

Notes: *; 1. This display shows the digits shown in the previous indication.
 2. If wrong key operation is made when moving from one to another item, the display is returned to the initial status of calibration mode. But, the mode is still in the calibration mode.

Figure 12-1. Calibration Flowchart (1/3)

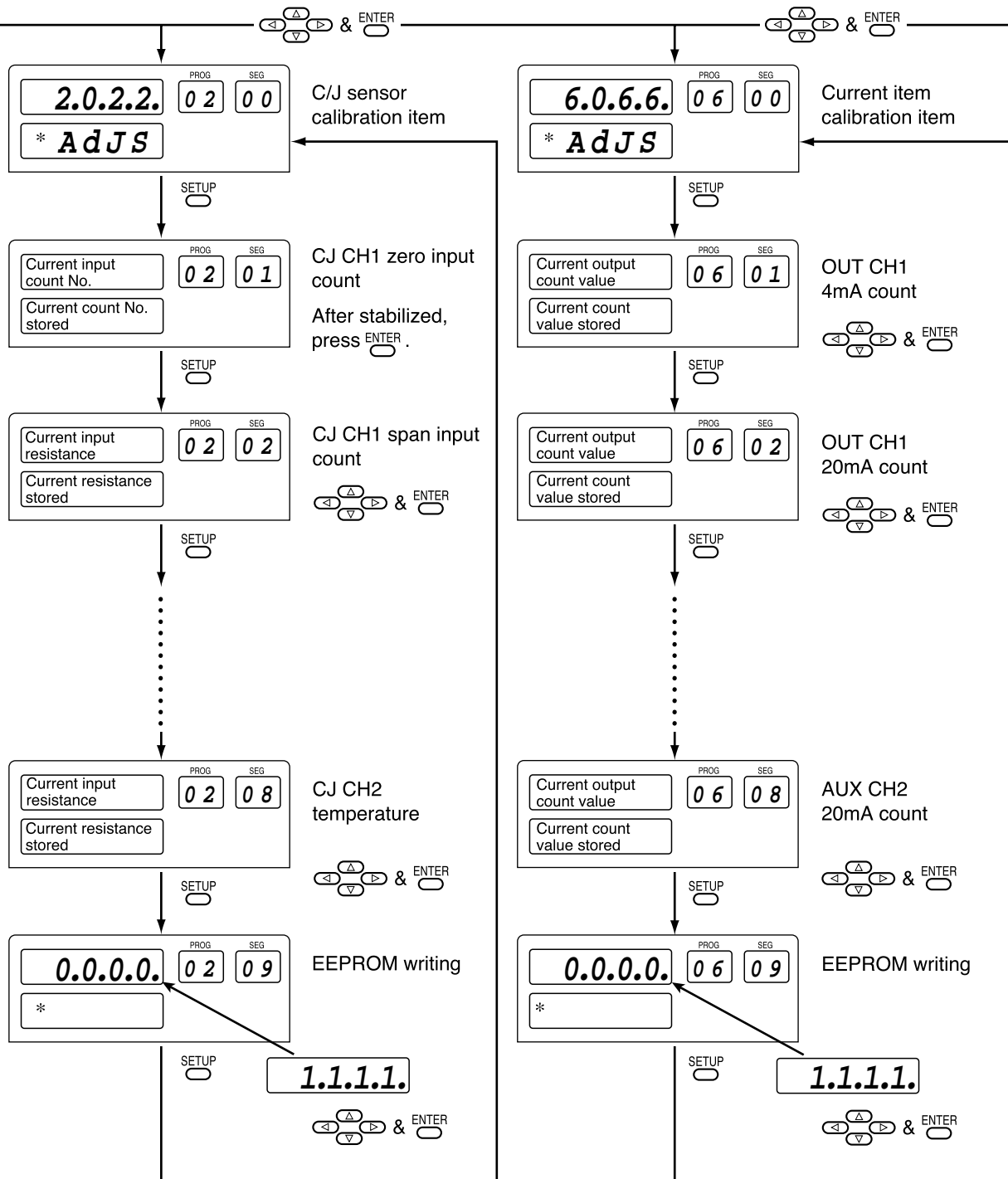

Figure 12-1. Calibration Flowchart (2/3)

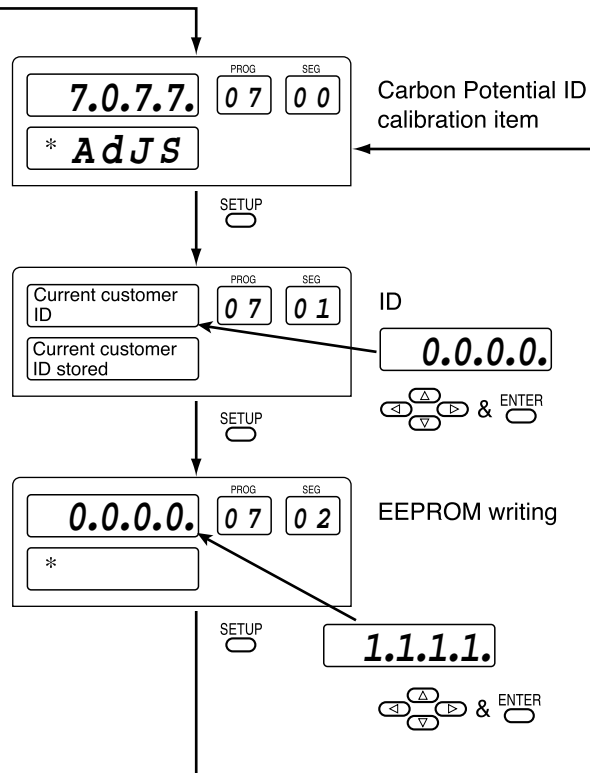

Figure 12-1. Calibration Flowchart (3/3)

12-2 Calibration Procedures

■ Enter calibration mode

- (1) Release keylock. (**PARA PA01=0**)
- (2) Press **DISP key** to permit ordinary indication condition.
Change to READY (**RUN** and **HLD** are off) and AUTO (**MAN** off) modes.
The following LEDs will illuminate after the above operations.
RUN LED is OFF
HLD LED is OFF
MAN LED is OFF

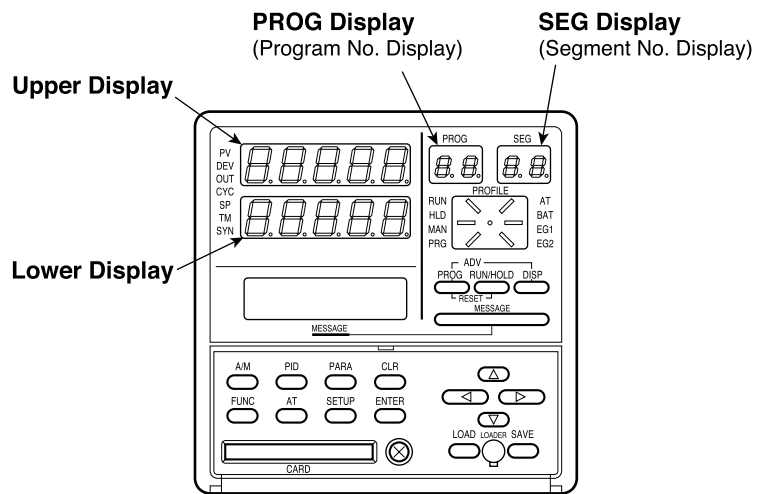

Figure 12-2.

- (3) To enter calibration mode, hold down the **FUNC key**, and press **SETUP key** and **ENTER key** simultaneously.
The display will show the symbols described in Figure 12-3. If the indication is different, repeat the above procedure after pushing **DISP key** to refresh the display.
- (4) To select individual calibration items, press **↑, ↓, ←, or → keys** to select the item by scrolling, then **SETUP key**, and **ENTER key**.
The order of calibration items is described in Table 12-2.

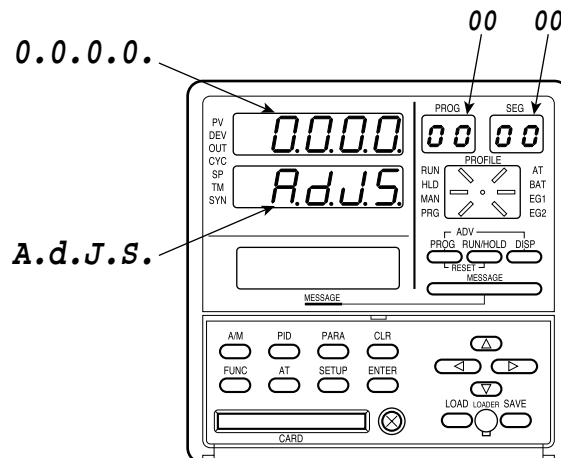

Figure 12-3.

■ Function test

Press \uparrow , \downarrow , \leftarrow , or \rightarrow **keys** to show (0.0.0.0) on upper display, then press **ENTER key**.

● Key test (00-01)

Press **SETUP key** until the PROG/SEG display shows (00-01).

When you press each key, the data appears in the upper display (shown in Table 12-3) and in the lower display (shown in Table 12-4).

Table 12-3. Upper Display

















Key	Data	Key	Data
ENTER 	2.0.0.0.	PID 	1.0.0.0.
AT 	0.2.0.0.	A/M 	0.8.0.0.
FUNC 	0.4.0.0.	PROG 	0.0.1.0.
CLR 	0.0.4.0.	RUN/HOLD 	0.0.0.8.
PARA 	0.0.2.0.	MESSAGE 	0.0.0.2.

Table 12-4. Lower Display

Key	Data	Key	Data
	2.0.0.0.		4.0.0.0.
	1.0.0.0.		0.8.0.0.
LOAD 	0.4.0.0.	SAVE 	0.2.0.0.

! HANDLING PRECAUTIONS

1. When you press **DISP key**, calibration mode will be exited.
2. When you press **SETUP key**, the next calibration menu will be entered (Display test).

●Display test (00-02)

Press **SETUP key** until the PROG/SEG display shows (00-02).

Then, each 7-segment LED, LED indicators and LCD illuminates at every 1 sec.

This is to check if each LED/LCD illuminates.

●Digital input test (00-03)

Press **SETUP key** until the PROG/SEG display shows (00-03).

When you turn on or off each remote switch, the upper display will show the data described in Table 12-5.

Table 12-5. DI

Upper Display \ DI Terminal Number	(1)	(2)	(3)	(4)	(13)	(14)	(15)	(16)	(25)	(26)	(29)	(30)	(33)	(34)	(37)	(38)
	↓ (12)	↓ (12)	↓ (12)	↓ (12)	↓ (12)	↓ (12)	↓ (12)	↓ (12)	↓ (41)	↓ (41)	↓ (41)	↓ (41)	↓ (41)	↓ (41)	↓ (41)	↓ (41)
0.0.0.0.	—	—	—	—	—	—	—	—	—	—	—	—	—	—	—	—
0.0.0.1.	ON	—	—	—	—	—	—	—	—	—	—	—	—	—	—	—
0.0.0.2.	—	ON	—	—	—	—	—	—	—	—	—	—	—	—	—	—
0.0.0.4.	—	—	ON	—	—	—	—	—	—	—	—	—	—	—	—	—
0.0.0.8.	—	—	—	ON	—	—	—	—	—	—	—	—	—	—	—	—
0.0.1.0.	—	—	—	—	ON	—	—	—	—	—	—	—	—	—	—	—
0.0.2.0.	—	—	—	—	—	ON	—	—	—	—	—	—	—	—	—	—
0.0.4.0.	—	—	—	—	—	—	ON	—	—	—	—	—	—	—	—	—
0.0.8.0.	—	—	—	—	—	—	—	ON	—	—	—	—	—	—	—	—
0.1.0.0.	—	—	—	—	—	—	—	—	ON	—	—	—	—	—	—	—
0.2.0.0.	—	—	—	—	—	—	—	—	—	ON	—	—	—	—	—	—
0.4.0.0.	—	—	—	—	—	—	—	—	—	—	ON	—	—	—	—	—
0.8.0.0.	—	—	—	—	—	—	—	—	—	—	—	ON	—	—	—	—
1.0.0.0.	—	—	—	—	—	—	—	—	—	—	—	—	ON	—	—	—
2.0.0.0.	—	—	—	—	—	—	—	—	—	—	—	—	—	ON	—	—
4.0.0.0.	—	—	—	—	—	—	—	—	—	—	—	—	—	—	ON	—
8.0.0.0.	—	—	—	—	—	—	—	—	—	—	—	—	—	—	—	ON

Notes: 1. "ON" means to short the terminals by a jumper.

2. "—" means to open the terminals.

Example:

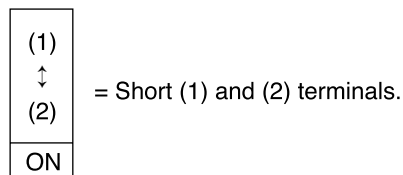

●Digital output test for control output (00-04)

Press **SETUP key** until the PROG/SEG display shows (00-04).

When the digit of upper display is changed by ↑, ↓, ←, or → **keys**, the state of 6D or 8D control output is changed as shown in Table 12-6.

Since the 6D hardware is of current output (8D hardware is of open collector) specification, the ON/OFF check must be performed in meeting with the specification.

Table 12-6.

Upper Display	State	Upper Display	State
0.0.0.0.	All OFF	0.0.0.4.	8D output CH1 ON
0.0.0.1.	6D output CH1 ON	0.0.0.8.	8D output CH2 ON
0.0.0.2.	6D output CH2 ON	—	—

●Digital output test for event (00-05)

Press **SETUP key** until the PROG/SEG display shows (00-05).

Table 12-7. DO

Upper Display \ DO Terminal Number	(5)	(6)	(7)	(8)	(17)	(18)	(19)	(20)	(10)	(11)	(22)	(23)	(27)	(28)	(31)	(32)
	↑ (9)	↑ (9)	↑ (9)	↑ (9)	↑ (9)	↑ (9)	↑ (9)	↑ (9)	↑ (24)	↑ (24)	↑ (24)	↑ (24)	↑ (24)	↑ (24)	↑ (24)	↑ (24)
0.0.0.0.	—	—	—	—	—	—	—	—	—	—	—	—	—	—	—	—
0.0.0.1.	ON	—	—	—	—	—	—	—	—	—	—	—	—	—	—	—
0.0.0.2.	—	ON	—	—	—	—	—	—	—	—	—	—	—	—	—	—
0.0.0.4.	—	—	ON	—	—	—	—	—	—	—	—	—	—	—	—	—
0.0.0.8.	—	—	—	ON	—	—	—	—	—	—	—	—	—	—	—	—
0.0.1.0.	—	—	—	—	ON	—	—	—	—	—	—	—	—	—	—	—
0.0.2.0.	—	—	—	—	—	ON	—	—	—	—	—	—	—	—	—	—
0.0.4.0.	—	—	—	—	—	—	ON	—	—	—	—	—	—	—	—	—
0.0.8.0.	—	—	—	—	—	—	—	ON	—	—	—	—	—	—	—	—
0.1.0.0.	—	—	—	—	—	—	—	—	ON	—	—	—	—	—	—	—
0.2.0.0.	—	—	—	—	—	—	—	—	—	ON	—	—	—	—	—	—
0.4.0.0.	—	—	—	—	—	—	—	—	—	—	ON	—	—	—	—	—
0.8.0.0.	—	—	—	—	—	—	—	—	—	—	—	ON	—	—	—	—
1.0.0.0.	—	—	—	—	—	—	—	—	—	—	—	—	ON	—	—	—
2.0.0.0.	—	—	—	—	—	—	—	—	—	—	—	—	—	ON	—	—
4.0.0.0.	—	—	—	—	—	—	—	—	—	—	—	—	—	—	ON	—
8.0.0.0.	—	—	—	—	—	—	—	—	—	—	—	—	—	—	—	ON

Notes: 1. “—” in the table means “OFF”.

2. Since the DO hardware is of open collector specification, the ON/OFF check must be performed in meeting with the specification.

● Built-in clock adjustment

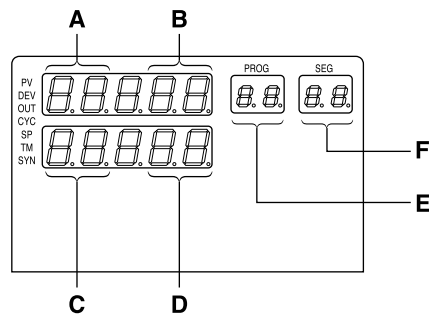

Figure 12-4.

Example:

A: 2 digits of calendar year	199393
B: Month	April04
C: Day	5th day05
D: Hour (24 hour system)	3PM15
E: Minute	6 minutes06
F: Second	Not changeable		

NOTE

1. \uparrow , \downarrow , \leftarrow , or \rightarrow **keys** are used to change the values, and **ENTER key** is used to store the values.
2. Clock is still progressing the operation even after the calibration step is moved to this built-in clock adjustment item. After entering the changing mode by **ENTER key**, the clock stops.
3. After pressing **ENTER key**, the clock starts from 0 second.
4. Writing to EEPROM is not necessary.

■ PV calibration

Scroll \uparrow , \downarrow , \leftarrow , or \rightarrow **keys** to show (**1011**) on upper display, then press **ENTER key**.

● Input CH No. select

Press **SETUP key** until the PROG/SEG display shows (**01-01**).

Input the channel No. by \uparrow , \downarrow , \leftarrow , or \rightarrow **keys** (**ENTER key** not required).

Table 12-8.

CH No.	Upper Display
1	0 0 0 0 0
2	0 0 0 0 1

● Gain No. select

Press **SETUP key** until the PROG/SEG display shows (01-02). Connect calibration device (See Section “12-3 Set Up”).

Input the gain number (See Table 12-9 and Table 12-10) by scrolling \uparrow , \downarrow , \leftarrow , or \rightarrow **keys** the upper display (**ENTER key** not required).

● PV zero, span

(1) PV zero adjustment

- (a) Press **SETUP key** until the PROG/SEG display shows **(01-03)**.
- (b) Adjust your calibration device to an output signal equal to the 0% range value (See Table 12-9), the signal need to be on the input for 10 to 15 seconds.
- (c) Press **ENTER key** after display stabilizes.

(2) PV span adjustment

- (a) Press **SETUP key** until the PROG/SEG display shows **(01-04)**.
- (b) Adjust your calibration device to an output signal equal to the 100% range value (See Table 12-9).
- (c) Press **ENTER key** after display stabilizes.

Table 12-9.

Gain No.	PV Input 0%	PV Input 100%	Connecting Position	Figure
0	-5.000mV	10.000mV	Between A(+) and B(-)	Fig.12-5
1	-10.000mV	18.000mV	Between A(+) and B(-)	
2	0.000mV	36.000mV	Between A(+) and B(-)	
3	0.000mV	52.000mV	Between A(+) and B(-)	
4	0.000mV	100.000mV	Between A(+) and B(-)	Fig.12-8
5	-1.000V	1.000V	Between A(+) and B(-)	
6	0.000V	5.000V	Between A(+) and B(-)	
7	0.000V	10.000V	Between A(+) and B(-)	
8	4.000mA	20.000mA	Between C(+) and B(-)	Fig.12-9
9	20Ω	140Ω	Between A(+) and B(-)	Fig.12-6
10	20Ω	480Ω	Between A(+) and B(-)	
11	1Ω	100Ω	Between C(+) and B(-)	Fig.12-7
12*	0.000V	1.250V	Between C(+) and B(-)	Fig.12-10

Note: *; If model isn't Carbon Potential, it isn't necessary to calibrate this item.

● Writing into EEPROM

- Press **SETUP key** until the PROG/SEG display shows **(01-05)**.
 Scroll ↑, ↓, ←, or → **keys** to show **(1.1.1.1.)** on the upper display.
 Press **ENTER key**.

Table 12-10.

Range Table of TC				Range Table of RTD			
Group	Type	Code	Gain No.	Group	Type	Code	Gain No.
T/C	K (CA)	K09	3	RTD	JIS '89 Pt100 (IEC Pt100Ω)	F50	10
	K (CA)	K08	2			F46	10
	K (CA)	K04	1			F32	10
	E (CRC)	E08	4			F36	10
	J (IC)	J08	3			F33	9
	T (CC)	T44	1			F01	9
	B (PR30-6)	B18	1			F03	10
	R (PR13)	R16	1			F05	10
	S (PR10)	S16	1			JIS '89 JPt100	P50
	W (WRe5-26)	W23	2		P46		10
	W (WRe5-26)	W14	2		P32		10
	PR40-20	D19	0		P36		10
	N	U13	3		P33		9
	PL II	Y13	3		P01		9
	Ni-Ni-Mo	Z13	4		P03		10
	Gold+0.07% Iron-chromel	Z06	0		P05		10
	K (CA)	K46	0				

Range Table of Linear			
Group	Type	Code	Gain No.
Linear mA	4 to 20mA	C01	8
Linear V	0 to 1V	L04	5
	-1 to +1V	L08	5
	1 to 5V	V01	6
	0 to 5V	L05	6
	0 to 10V	L07	7
Linear mA	2.4 to 20mV	Z52	8
Linear mV	0 to 10mV	M01	0
	-10 to +10mV	L02	1
	0 to 100mV	L01	4
O ₂ Sensor	0 to 1.25V		12

■ Cold junction sensor calibration

Scroll \uparrow , \downarrow , \leftarrow , or \rightarrow **keys** to show (2022) on upper display, then press **ENTER key**.

● The cold junction input 0% (CH1)

- (1) Press **SETUP key** until the PROG/SEG display shows (02-01).
- (2) Connect the millivolt source between (55)(-) and (56)(+), and then input 0.2V (See Figure 12-10).
- (3) Press **ENTER key** after display stabilizes, AD count is shown on lower display.

● The cold junction input 100% (CH1)

- (1) Press **SETUP key** until the PROG/SEG display shows (02-02).
- (2) Connect the millivolt source between (55)(-) and (56)(+), and then input 1.0V (See Figure 12-10).
- (3) Press **ENTER key** after display stabilizes, AD count is shown on lower display.

● The cold junction AD count data (CH1)

- (1) Press **SETUP key** until the PROG/SEG display shows (02-03).
- (2) Press **ENTER key** after display stabilizes, AD count is shown on lower display.

● The cold junction temperature data (CH1)

- (1) Press **SETUP key** until the PROG/SEG display shows (02-04).
- (2) Connect the thermometer (55).
- (3) Scroll \uparrow , \downarrow , \leftarrow , or \rightarrow **keys** to set above temperature value.
- (4) Press **ENTER key**.

● The cold junction input 0% (CH2)

- (1) Press **SETUP key** until the PROG/SEG display shows (02-05).
- (2) Connect the millivolt source between (58)(-) and (59)(+), and then input 0.2V (See Figure 12-10).
- (3) Press **ENTER key** after display stabilizes, AD count is shown on lower display.

● The cold junction input 100% (CH2)

- (1) Press **SETUP key** until the PROG/SEG display shows (02-06).
- (2) Connect the millivolt source between (58)(-) and (59)(+), and then input 1.0V (See Figure 12-10).
- (3) Press **ENTER key** after display stabilizes, AD count is shown on lower display.

● The cold junction AD count data (CH2)

- (1) Press **SETUP key** until the PROG/SEG display shows (02-07).
- (2) Press **ENTER key** after display stabilizes, AD count is shown on lower display.

● The cold junction temperature data (CH2)

- (1) Press **SETUP key** until the PROG/SEG display shows (02-08).
- (2) Connect the thermometer (58).
- (3) Scroll \uparrow , \downarrow , \leftarrow , or \rightarrow **keys** to set above temperature value.
- (4) Press **ENTER key**.

● Writing into EEPROM

- (1) Press **SETUP key** until the PROG/SEG display shows (02-09).
- (2) Scroll \uparrow , \downarrow , \leftarrow , or \rightarrow **keys** to show (1.1.1.1.) on upper display.
- (3) Press **ENTER key**.

■ Current output calibration

Scroll \uparrow , \downarrow , \leftarrow , or \rightarrow **keys** to show (6.0.6.6.) on the upper display, then press **ENTER key**.

Connect the digital ammeter across terminals (See Figure 12-9).

● OUT CH1 output calibration

(1) Press **SETUP key** until the PROG/SEG display shows (06-01).

Scroll \uparrow , \downarrow , \leftarrow , or \rightarrow **keys** until meter indicates 4.00mA, then press **ENTER key**.

(2) Press **SETUP key** until the PROG/SEG display shows (06-02).

Scroll \uparrow , \downarrow , \leftarrow , or \rightarrow **keys** until meter indicates 20.00mA, then press **ENTER key**.

● OUT CH2 output calibration

(1) Press **SETUP key** until the PROG/SEG display shows (06-03).

Scroll \uparrow , \downarrow , \leftarrow , or \rightarrow **keys** until meter indicates 4.00mA, then press **ENTER key**.

(2) Press **SETUP key** until the PROG/SEG display shows (06-04).

Scroll \uparrow , \downarrow , \leftarrow , or \rightarrow **keys** until meter indicates 20.00mA, then press **ENTER key**.

● AUX CH1 output calibration

(1) Press **SETUP key** until the PROG/SEG display shows (06-05).

Scroll \uparrow , \downarrow , \leftarrow , or \rightarrow **keys** until meter indicates 4.00mA, then press **ENTER key**.

(2) Press **SETUP key** until the PROG/SEG display shows (06-06).

Scroll \uparrow , \downarrow , \leftarrow , or \rightarrow **keys** until meter indicates 20.00mA, then press **ENTER key**.

● AUX CH2 output calibration

(1) Press **SETUP key** until the PROG/SEG display shows (06-07).

Scroll \uparrow , \downarrow , \leftarrow , or \rightarrow **keys** until meter indicates 4.00mA, then press **ENTER key**.

(2) Press **SETUP key** until the PROG/SEG display shows (06-08).

Scroll \uparrow , \downarrow , \leftarrow , or \rightarrow **keys** until meter indicates 20.00mA, then press **ENTER key**.

● **Writing into EEPROM**

- (1) Press **SETUP key** until the PROG/SEG display shows **(06-09)**.
Scroll **↑, ↓, ←, or → keys** to show **(1.1.1.1.)** on upper display.
- (2) Press **ENTER key**.

12-3 Set Up

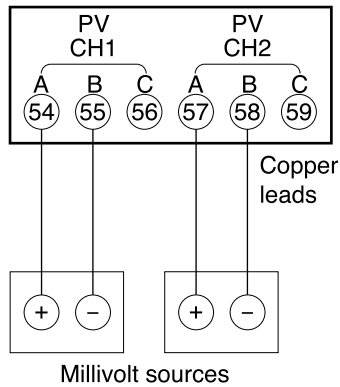

Figure 12-5. Thermocouple Inputs

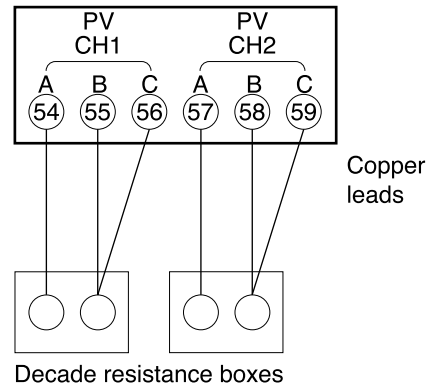

Figure 12-6. RTD Inputs

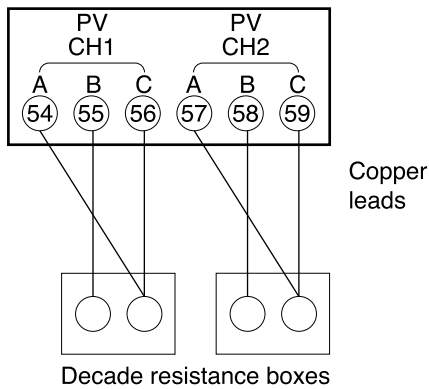

Figure 12-7. RTD Inputs

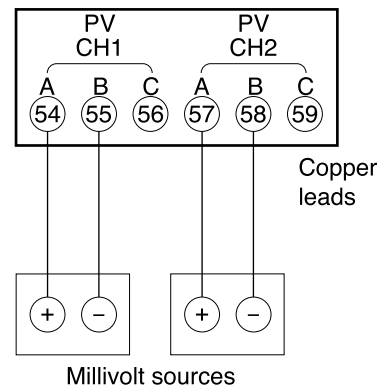

Figure 12-8. mV, V, Inputs

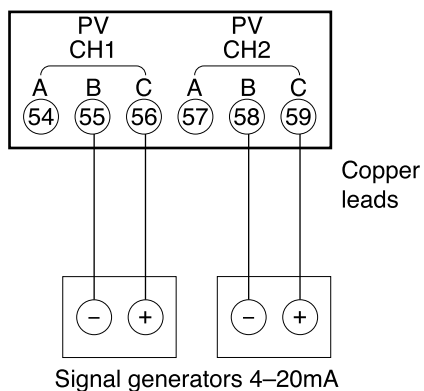

Figure 12-9. mA Inputs

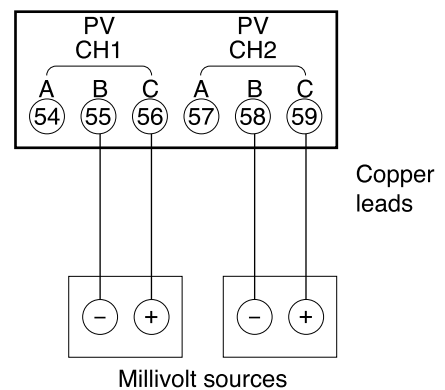

Figure 12-10. CJ, O₂ Sensor

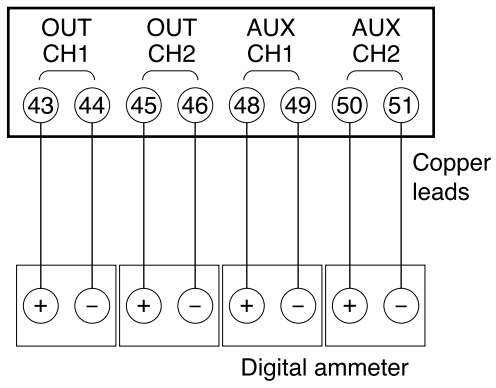



Figure 12-11. Current Outputs

DCP551 Parameter Work Sheet

User name	:	Preparation date
Equipment name	:	Product name
Model No.	:DCP551	Tag name
Instrumentation staffer in charge	:	Business staffer in charge

■ Variable parameter setting

No.	Item code	Item	Factory default settings	User settings	Settings and descriptions
1	PA 01	Key lock	0		0 : Keylock disabled 1 : Display of setup data settings disabled 2 : Display of all settings disabled 3 : Display of all settings disabled. Operation keys disabled.
2	PA 02	Memory protect	0		0 : Disabled 1 : Program settings are protected. 2 : Setup, variable parameters and event configuration settings are protected. 3 : Setup, variable parameters, event configurations and program settings are protected. 4 : Setup, variable parameters, event configurations and PID parameter settings are protected. 5 : Program settings and all parameter settings are protected.
5	PA 05	Program auto load	0		0 : OFF 1 : ON
8	PA 08	Auto-tuning	0		0 : AT not performed 1 : Standard AT performed on currently used PID group in mode other than READY mode 2 : AT writing overshoot-proof PID values to currently used PID groups in mode other than READY mode performed 3 : Standard AT performed on PID groups A1 to A7 in READY mode 4 : AT writing overshoot-proof PID values to PID groups A1 to A7 in READY mode continuously performed
9	PA 09	Auto-tuning MV lower limit	0.0		-5.0 to upper limit %
10	PA 10	Auto-tuning MV higher limit	100.0		Lower limit to +105%
11	PA 11	SP bias	0 SPU		-10000 to +10000 SPU
12	PA 12	PV1 digital filter	0.0		0.0 to 120.0sec
13	PA 13	PV1 bias	0 PVU		-1000 to +1000 PVU(PV1)
14	PA 14	Manipulated variable deviation limit	110.0		0.1 to 110.0% OUT / 0.1sec
15	PA 15	Time proportional output cycle	10		1 to 240sec
16	PA 16	On-off control differential	50 SPU		0 to 1000 SPU
17	PA 17	PID computation initialize manipulated variable	0.0		-5.0 to +105.0%
22	PA 22	PV2 digital filter	0.0		0.0 to 120.0sec
23	PA 23	PV2 bias	0 PVU		-1000 to +1000 PVU(PV2)
31	PA 31	Group 1 event number	0		0 to 16 (0: No delay is specified.)
32	PA 32	Group 1 delay time	0.0		0.0 to 3000.0sec
33	PA 33	Group 2 event number	0		0 to 16 (0: No delay is specified.)
34	PA 34	Group 2 delay time	0.0		0.0 to 3000.0sec
35	PA 35	Group 3 event number	0		0 to 16 (0: No delay is specified.)
36	PA 36	Group 3 delay time	0.0		0.0 to 3000.0sec
37	PA 37	Group 4 event number	0		0 to 16 (0: No delay is specified.)
38	PA 38	Group 4 delay time	0.0		0.0 to 3000.0sec
39	PA 39	FAST X	0		0 : 2 X 1 : 10 X 2 : 60 X 3 : 120 X

 denotes items settable only on models with two PV input channels.

DCP551 Parameter Work Sheet

No.	Item code	Item	Factory default-settings	User settings	Settings and descriptions
41	PA 41	EG1 LED display event number	0		0 to 16 (0: EG1 LED is off.)
42	PA 42	EG2 LED display event number	0		0 to 16 (0: EG2 LED is off.)
43	PA 43	PID operation initialize	0		0 : No initialization during advance processing and PID group change 1 : Initializes during advance processing but not during PID group change. 2 : No initialization during advance processing but initializes during PID group change. 3 : Initializes both during advance processing and PID group change.
46	PA 46	G.SOAK time	2.0		0.1 to 60.0sec
51	PA 51	PV1 equalizer compensation point No. 1	Range lower limit value		PV1 range lower limit value (tied)
52	PA 52	PV1 equalizer compensation amount No. 1	0 PVU		-1000 to +1000 PVU(PV1)
53	PA 53	PV1 equalizer compensation point No. 2	500 PVU		-19999 to +20000 PVU(PV1)
54	PA 54	PV1 equalizer compensation amount No. 2	0 PVU		-1000 to +1000 PVU(PV1)
55	PA 55	PV1 equalizer compensation point No. 3	1000 PVU		-19999 to +20000 PVU(PV1)
56	PA 56	PV1 equalizer compensation amount No. 3	0 PVU		-1000 to +1000 PVU(PV1)
57	PA 57	PV1 equalizer compensation point No. 4	1500 PVU		-19999 to +20000 PVU(PV1)
58	PA 58	PV1 equalizer compensation amount No. 4	0 PVU		-1000 to +1000 PVU(PV1)
59	PA 59	PV1 equalizer compensation point No. 5	2000 PVU		-19999 to +20000 PVU(PV1)
60	PA 60	PV1 equalizer compensation amount No. 5	0 PVU		-1000 to +1000 PVU(PV1)
61	PA 61	PV1 equalizer compensation point No. 6	2500 PVU		-19999 to +20000 PVU(PV1)
62	PA 62	PV1 equalizer compensation amount No. 6	0 PVU		-1000 to +1000 PVU(PV1)
63	PA 63	PV1 equalizer compensation point No. 7	3000 PVU		-19999 to +20000 PVU(PV1)
64	PA 64	PV1 equalizer compensation amount No. 7	0 PVU		-1000 to +1000 PVU(PV1)
65	PA 65	PV1 equalizer compensation point No. 8	3500 PVU		-19999 to +20000 PVU(PV1)
66	PA 66	PV1 equalizer compensation amount No. 8	0 PVU		-1000 to +1000 PVU(PV1)
67	PA 67	PV1 equalizer compensation point No. 9	4000 PVU		-19999 to +20000 PVU(PV1)
68	PA 68	PV1 equalizer compensation amount No. 9	0 PVU		-1000 to +1000 PVU(PV1)
69	PA 69	PV1 equalizer compensation point No. 10	Range upper limit value		PV1 range upper limit value (tied)
70	PA 70	PV1 equalizer compensation amount No. 10	0 PVU		-1000 to +1000 PVU(PV1)
71	PA 71	PV2 equalizer compensation point No. 1	Low-limit value of range		PV2 range lower limit value (tied)
72	PA 72	PV2 equalizer compensation amount No. 1	0 PVU		-1000 to +1000 PVU(PV2)
73	PA 73	PV2 equalizer compensation point No. 2	500 PVU		-19999 to +20000 PVU(PV2)
74	PA 74	PV2 equalizer compensation amount No. 2	0 PVU		-1000 to +1000 PVU(PV2)
75	PA 75	PV2 equalizer compensation point No. 3	1000 PVU		-19999 to +20000 PVU(PV2)
76	PA 76	PV2 equalizer compensation amount No. 3	0 PVU		-1000 to +1000 PVU(PV2)
77	PA 77	PV2 equalizer compensation point No. 4	1500 PVU		-19999 to +20000 PVU(PV2)
78	PA 78	PV2 equalizer compensation amount No. 4	0 PVU		-1000 to +1000 PVU(PV2)
79	PA 79	PV2 equalizer compensation point No. 5	2000 PVU		-19999 to +20000 PVU(PV2)
80	PA 80	PV2 equalizer compensation amount No. 5	0 PVU		-1000 to +1000 PVU(PV2)
81	PA 81	PV2 equalizer compensation point No. 6	2500 PVU		-19999 to +20000 PVU(PV2)
82	PA 82	PV2 equalizer compensation amount No. 6	0 PVU		-1000 to +1000 PVU(PV2)
83	PA 83	PV2 equalizer compensation point No. 7	3000 PVU		-19999 to +20000 PVU(PV2)
84	PA 84	PV2 equalizer compensation amount No. 7	0 PVU		-1000 to +1000 PVU(PV2)
85	PA 85	PV2 equalizer compensation point No. 8	3500 PVU		-19999 to +20000 PVU(PV2)
86	PA 86	PV2 equalizer compensation amount No. 8	0 PVU		-1000 to +1000 PVU(PV2)
87	PA 87	PV2 equalizer compensation point No. 9	4000 PVU		-19999 to +20000 PVU(PV2)

 denotes items settable only on models with two PV input channels.

DCP551 Parameter Work Sheet

No.	Item code	Item	Factory default- settings	User settings	Settings and descriptions
88	PA 88	PV2 equalizer compensation amount No. 9	0 PVU		-1000 to +1000 PVU (PV2)
89	PA 89	PV2 equalizer compensation point No. 10	4500 PVU		-19999 to +20000 PVU(PV2)
90	PA 90	PV2 equalizer compensation amount No. 10	0 PVU		-1000 to +1000 PVU(PV2)
91	PA 91	PV2 equalizer compensation point No. 11	5000 PVU		-19999 to +20000 PVU(PV2)
92	PA 92	PV2 equalizer compensation amount No. 11	0 PVU		-1000 to +1000 PVU(PV2)
93	PA 93	PV2 equalizer compensation point No. 12	5500 PVU		-19999 to +20000 PVU(PV2)
94	PA 94	PV2 equalizer compensation amount No. 12	0 PVU		-1000 to +1000 PVU(PV2)
95	PA 95	PV2 equalizer compensation point No. 13	6000 PVU		-19999 to +20000 PVU(PV2)
96	PA 96	PV2 equalizer compensation amount No. 13	0 PVU		-1000 to +1000 PVU(PV2)
97	PA 97	PV2 equalizer compensation point No. 14	6500 PVU		-19999 to +20000 PVU(PV2)
98	PA 98	PV2 equalizer compensation amount No. 14	0 PVU		-1000 to +1000 PVU(PV2)
99	PA 99	PV2 equalizer compensation point No. 15	7000 PVU		-19999 to +20000 PVU(PV2)
100	PA100	PV2 equalizer compensation amount No. 15	0 PVU		-1000 to +1000 PVU(PV2)
101	PA101	PV2 equalizer compensation point No. 16	7500 PVU		-19999 to +20000 PVU(PV2)
102	PA102	PV2 equalizer compensation amount No. 16	0 PVU		-1000 to +1000 PVU(PV2)
103	PA103	PV2 equalizer compensation point No. 17	8000 PVU		-19999 to +20000 PVU(PV2)
104	PA104	PV2 equalizer compensation amount No. 17	0 PVU		-1000 to +1000 PVU(PV2)
105	PA105	PV2 equalizer compensation point No. 18	8500 PVU		-19999 to +20000 PVU(PV2)
106	PA106	PV2 equalizer compensation amount No. 18	0 PVU		-1000 to +1000 PVU(PV2)
107	PA107	PV2 equalizer compensation point No. 19	9000 PVU		-19999 to +20000 PVU(PV2)
108	PA108	PV2 equalizer compensation amount No. 19	0 PVU		-1000 to +1000 PVU(PV2)
109	PA109	PV2 equalizer compensation point No. 20	Range upper limit		PV2 range upper limit value (tied)
110	PA110	PV2 equalizer compensation amount No. 20	0 PVU		-1000 to +1000 PVU(PV2)
111	PA111	PV1 ratio	1.000		0.001 to 9.999
112	PA112	PV2 ratio	1.000		0.001 to 9.999

denotes items settable only on models with two PV input channels.

DCP551 Parameter Work Sheet

■ Event configuration data setting

No.	Item code	Item	Factory default- settings	User settings	Settings and descriptions
1	E01-t	Event 1 event type	0		0 to 253
2	E01-1	Event 1 auxiliary setting 1	----		-19999 to +20000 (Setting range is variable according to the event types.)
3	E01-2	Event 1 auxiliary setting 2	----		-19999 to +20000 (Setting range is variable according to the event types.)
4	E02-t	Event 2 event type	0		0 to 253
5	E02-1	Event 2 auxiliary setting 1	----		-19999 to +20000 (Setting range is variable according to the event types.)
6	E02-2	Event 2 auxiliary setting 2	----		-19999 to +20000 (Setting range is variable according to the event types.)
7	E03-t	Event 3 event type	0		0 to 253
8	E03-1	Event 3 auxiliary setting 1	----		-19999 to +20000 (Setting range is variable according to the event types.)
9	E03-2	Event 3 auxiliary setting 2	----		-19999 to +20000 (Setting range is variable according to the event types.)
10	E04-t	Event 4 event type	0		0 to 253
11	E04-1	Event 4 auxiliary setting 1	----		-19999 to +20000 (Setting range is variable according to the event types.)
12	E04-2	Event 4 auxiliary setting 2	----		-19999 to +20000 (Setting range is variable according to the event types.)
13	E05-t	Event 5 event type	0		0 to 253
14	E05-1	Event 5 auxiliary setting 1	----		-19999 to +20000 (Setting range is variable according to the event types.)
15	E05-2	Event 5 auxiliary setting 2	----		-19999 to +20000 (Setting range is variable according to the event types.)
16	E06-t	Event 6 event type	0		0 to 253
17	E06-1	Event 6 auxiliary setting 1	----		-19999 to +20000 (Setting range is variable according to the event types.)
18	E06-2	Event 6 auxiliary setting 2	----		-19999 to +20000 (Setting range is variable according to the event types.)
19	E07-t	Event 7 event type	0		0 to 253
20	E07-1	Event 7 auxiliary setting 1	----		-19999 to +20000 (Setting range is variable according to the event types.)
21	E07-2	Event 7 auxiliary setting 2	----		-19999 to +20000 (Setting range is variable according to the event types.)
22	E08-t	Event 8 event type	0		0 to 253
23	E08-1	Event 8 auxiliary setting 1	----		-19999 to +20000 (Setting range is variable according to the event types.)
24	E08-2	Event 8 auxiliary setting 2	----		-19999 to +20000 (Setting range is variable according to the event types.)
25	E09-t	Event 9 event type	0		0 to 253
26	E09-1	Event 9 auxiliary setting 1	----		-19999 to +20000 (Setting range is variable according to the event types.)
27	E09-2	Event 9 auxiliary setting 2	----		-19999 to +20000 (Setting range is variable according to the event types.)
28	E10-t	Event 10 event type	0		0 to 253
29	E10-1	Event 10 auxiliary setting 1	----		-19999 to +20000 (Setting range is variable according to the event types.)
30	E10-2	Event 10 auxiliary setting 2	----		-19999 to +20000 (Setting range is variable according to the event types.)
31	E11-t	Event 11 event type	0		0 to 253
32	E11-1	Event 11 auxiliary setting 1	----		-19999 to +20000 (Setting range is variable according to the event types.)
33	E11-2	Event 11 auxiliary setting 2	----		-19999 to +20000 (Setting range is variable according to the event types.)

No.	Item code	Item	Factory default- settings	User settings	Settings and descriptions
34	E12-t	Event 12 event type	0		0 to 253
35	E12-1	Event 12 auxiliary setting 1	----		-19999 to +20000 (Setting range is variable according to the event types.)
36	E12-2	Event 12 auxiliary setting 2	----		-19999 to +20000 (Setting range is variable according to the event types.)
37	E13-t	Event 13 event type	0		0 to 253
38	E13-1	Event 13 auxiliary setting 1	----		-19999 to +20000 (Setting range is variable according to the event types.)
39	E13-2	Event 13 auxiliary setting 2	----		-19999 to +20000 (Setting range is variable according to the event types.)
40	E14-t	Event 14 event type	0		0 to 253
41	E14-1	Event 14 auxiliary setting 1	----		-19999 to +20000 (Setting range is variable according to the event types.)
42	E14-2	Event 14 auxiliary setting 2	----		-19999 to +20000 (Setting range is variable according to the event types.)
43	E15-t	Event 15 event type	0		0 to 253
44	E15-1	Event 15 auxiliary setting 1	----		-19999 to +20000 (Setting range is variable according to the event types.)
45	E15-2	Event 15 auxiliary setting 2	----		-19999 to +20000 (Setting range is variable according to the event types.)
46	E16-t	Event 16 event type	0		0 to 253
47	E16-1	Event 16 auxiliary setting 1	----		-19999 to +20000 (Setting range is variable according to the event types.)
48	E16-2	Event 16 auxiliary setting 2	----		-19999 to +20000 (Setting range is variable according to the event types.)

● Event type

Event type	Meaning	Setting category	Operation category	Auxiliary settings	
0	Event off	----	----	Auxiliary 1 : None	Auxiliary 2 : None
1	Time event	Segment	Time	Auxiliary 1 : None	Auxiliary 2 : None
2	PV upper limit	Segment	PV	Auxiliary 1 : Hysteresis	Auxiliary 2 : None
3	PV lower limit				
4	Deviation upper limit				
5	Deviation lower limit				
6	Deviation upper limit with standby				
7	Deviation lower limit with standby				
8	Absolute value deviation upper limit				
9	Absolute value deviation lower limit				
10	Absolute value deviation upper limit with standby				
11	Absolute value deviation lower limit with standby				
12	PV deviation rate upper limit				
13	PV deviation rate lower limit				
14	SP upper limit	Segment	PV	Auxiliary 1 : Hysteresis	Auxiliary 2 : None
15	SP lower limit				
16	MV upper limit				
17	MV lower limit				
18	Code event	Segment	Code	Auxiliary 1 : No. of output	Auxiliary 2 : None
19	SOAK absolute value deviation upper limit	Segment	PV	Auxiliary 1 : Hysteresis	Auxiliary 2 : None
20	SOAK absolute value deviation lower limit				
21	SOAK absolute value deviation upper limit with standby				
22	SOAK absolute value deviation lower limit with standby				
23	Code event with timer	Segment	Code time	Auxiliary 1 : No. of output	Auxiliary 2 : None

DCP551 Parameter Work Sheet

Event type	Meaning	Setting category	Operation category	Auxiliary settings	
24 to 63	Event off	-----	-----	Auxiliary 1 : None	Auxiliary 2 : None
64	Normal PV1 upper limit operation	Measuring instrument	PV	Auxiliary 1 : Hysteresis	Auxiliary 2 : Operating point
65	Normal PV1 lower limit operation				
66	Normal PV2 upper limit operation				
67	Normal PV2 lower limit operation				
68	PV upper limit				
69	PV lower limit				
70	Deviation upper limit				
71	Deviation lower limit				
72	Deviation upper limit with standby				
73	Deviation lower limit with standby				
74	Absolute value deviation upper limit				
75	Absolute value deviation lower limit				
76	Absolute value deviation upper limit with standby				
77	Absolute value deviation lower limit with standby				
78	PV deviation rate upper limit	Measuring instrument	PV	Auxiliary 1 : Sampling cycle	Auxiliary 2 : Operating point
79	PV deviation rate lower limit				
80	SP upper limit	Measuring instrument	PV	Auxiliary 1 : Hysteresis	Auxiliary 2 : Operating point
81	SP lower limit				
82	MV upper limit				
83	MV lower limit				
84	SOAK absolute value deviation upper limit				
85	SOAK absolute value deviation lower limit				
86	SOAK absolute value deviation upper limit with standby				
87	SOAK absolute value deviation lower limit with standby				
88	Program No. binary code	Measuring instrument	Code	Auxiliary 1 : No. of output	Auxiliary 2 : None
89	Segment No. binary code				
90	Program No. BCD code				
91	Segment No. BCD code				
92	Specified segment	Measuring instrument	Mode	Auxiliary 1 : Segment specification	Auxiliary 2 : None
93	RAMP-E monitoring time	Measuring instrument	Time	Auxiliary 1 : Operating point	Auxiliary 2 : None
94	Segment time	Measuring instrument	Time	Auxiliary 1 : On-time	Auxiliary 2 : OFF-time
95	Program time				
96	PV1-PV2 differential upper limit during CH switching	Measuring instrument	PV	Auxiliary 1 : None	Auxiliary 2 : Operating point
97	PV1-PV2 differential lower limit during CH switching				
98	PV1-PV2 differential upper limit	Measuring instrument	PV	Auxiliary 1 : Hysteresis	Auxiliary 2 : Operating point
99	PV1-PV2 differential lower limit				
100 to 127	Event off	-----	-----	Auxiliary 1 : None	Auxiliary 2 : None
128	RUN, HOLD, END, FAST	Measuring instrument	Mode	Auxiliary 1 : None	Auxiliary 2 : None
129	HOLD				
130	READY, READY FAST				
131	END				
132	G.SOAK wait				
133	MANUAL				
134	AT executing				
135	FAST, READY FAST				
136	Console setting operation				
137	RUN				

DCP551 Parameter Work Sheet

Event type	Meaning	Setting category	Operation category	Auxiliary settings	
138	Advance	Measuring instrument	Mode	Auxiliary 1: None	Auxiliary 2: None
139	All alarms (logical OR)				
140	PV range alarm				
141	Instrument alarm				
142	PV1 selection				
143	PV2 selection				
144	Battery voltage drop				
145 to 253	Event off	-----	-----	Auxiliary 1: None	Auxiliary 2: None

DCP551 Parameter Work Sheet

■ PID parameter setting

No.	Item code	Item	Factory default- settings	User settings	Settings and descriptions
1	<i>P-1</i>	Proportional band (PID group 1)	100.0		0.0 to 1000.0% (0.0: On-off control)
2	<i>I-1</i>	Integral time (PID group 1)	0		0 to 3600sec (0: no integral operation)
3	<i>d-1</i>	Derivative time (PID group 1)	0		0 to 1200sec (0: no derivative operation)
4	<i>rE-1</i>	Manual reset (PID group 1)	50.0		0.0 to 100.0%
5	<i>oL-1</i>	Manipulated variable lower limit (Output limiter group 1)	0.0		-5.0 to manipulated variable upper limit %
6	<i>oH-1</i>	Manipulated variable upper limit (Output limiter group 1)	100.0		Manipulated variable lower limit to +105.0%
7	<i>P-2</i>	Proportional band (PID group 2)	100.0		0.0 to 1000.0% (0.0: On-off control)
8	<i>I-2</i>	Integral time (PID group 2)	0		0 to 3600sec (0: no integral operation)
9	<i>d-2</i>	Derivative time (PID group 2)	0		0 to 1200sec (0: no derivative operation)
10	<i>rE-2</i>	Manual reset (PID group 2)	50.0		0.0 to 100.0%
11	<i>oL-2</i>	Manipulated variable lower limit (Output limiter group 2)	0.0		-5.0 to manipulated variable upper limit %
12	<i>oH-2</i>	Manipulated variable upper limit (Output limiter group 2)	100.0		Manipulated variable lower limit to +105.0%
13	<i>P-3</i>	Proportional band (PID group 3)	100.0		0.0 to 1000.0% (0.0: On-off control)
14	<i>I-3</i>	Integral time (PID group 3)	0		0 to 3600sec (0: no integral operation)
15	<i>d-3</i>	Derivative time (PID group 3)	0		0 to 1200sec (0: no derivative operation)
16	<i>rE-3</i>	Manual reset (PID group 3)	50.0		0.0 to 100.0%
17	<i>oL-3</i>	Manipulated variable lower limit (Output limiter group 3)	0.0		-5.0 to manipulated variable upper limit %
18	<i>oH-3</i>	Manipulated variable upper limit (Output limiter group 3)	100.0		Manipulated variable lower limit to +105.0%
19	<i>P-4</i>	Proportional band (PID group 4)	100.0		0.0 to 1000.0% (0.0: On-off control)
20	<i>I-4</i>	Integral time (PID group 4)	0		0 to 3600sec (0: no integral operation)
21	<i>d-4</i>	Derivative time (PID group 4)	0		0 to 1200sec (0: no derivative operation)
22	<i>rE-4</i>	Manual reset (PID group 4)	50.0		0.0 to 100.0%
23	<i>oL-4</i>	Manipulated variable lower limit (Output limiter group 4)	0.0		-5.0 to manipulated variable upper limit %
24	<i>oH-4</i>	Manipulated variable upper limit (Output limiter group 4)	100.0		Manipulated variable lower limit to +105.0%
25	<i>P-5</i>	Proportional band (PID group 5)	100.0		0.0 to 1000.0% (0.0: On-off control)
26	<i>I-5</i>	Integral time (PID group 5)	0		0 to 3600sec (0: no integral operation)
27	<i>d-5</i>	Derivative time (PID group 5)	0		0 to 1200sec (0: no derivative operation)
28	<i>rE-5</i>	Manual reset (PID group 5)	50.0		0.0 to 100.0%
29	<i>oL-5</i>	Manipulated variable lower limit (Output limiter group 5)	0.0		-5.0 to manipulated variable upper limit %
30	<i>oH-5</i>	Manipulated variable upper limit (Output limiter group 5)	100.0		Manipulated variable lower limit to +105.0%
31	<i>P-6</i>	Proportional band (PID group 6)	100.0		0.0 to 1000.0% (0.0: On-off control)
32	<i>I-6</i>	Integral time (PID group 6)	0		0 to 3600sec (0: no integral operation)
33	<i>d-6</i>	Derivative time (PID group 6)	0		0 to 1200sec (0: no derivative operation)
34	<i>rE-6</i>	Manual reset (PID group 6)	50.0		0.0 to 100.0%
35	<i>oL-6</i>	Manipulated variable lower limit (Output limiter group 6)	0.0		-5.0 to manipulated variable upper limit %
36	<i>oH-6</i>	Manipulated variable upper limit (Output limiter group 6)	100.0		Manipulated variable lower limit to +105.0%

DCP551 Parameter Work Sheet

No.	Item code	Item	Factory default-settings	User settings	Settings and descriptions
37	P-7	Proportional band (PID group 7)	100.0		0.0 to 1000.0% (0.0: On-off control)
38	I-7	Integral time (PID group 7)	0		0 to 3600sec (0: no integral operation)
39	d-7	Derivative time (PID group 7)	0		0 to 1200sec (0: no derivative operation)
40	rE-7	Manual reset (PID group 7)	50.0		0.0 to 100.0%
41	oL-7	Manipulated variable lower limit (Output limiter group 7)	0.0		-5.0 to manipulated variable upper limit %
42	oH-7	Manipulated variable upper limit (Output limiter group 7)	100.0		Manipulated variable lower limit to +105.0%
43	P-8	Proportional band (PID group 8)	100.0		0.0 to 1000.0% (0.0: On-off control)
44	I-8	Integral time (PID group 8)	0		0 to 3600sec (0: no integral operation)
45	d-8	Derivative time (PID group 8)	0		0 to 1200sec (0: no derivative operation)
46	rE-8	Manual reset (PID group 8)	50.0		0.0 to 100.0%
47	oL-8	Manipulated variable lower limit (Output limiter group 8)	0.0		-5.0 to manipulated variable upper limit %
48	oH-8	Manipulated variable upper limit (Output limiter group 8)	100.0		Manipulated variable lower limit to +105.0%
49	P-9	Proportional band (PID group 9)	100.0		0.0 to 1000.0% (0.0: On-off control)
50	I-9	Integral time (PID group 9)	0		0 to 3600sec (0: no integral operation)
51	d-9	Derivative time (PID group 9)	0		0 to 1200sec (0: no derivative operation)
52	rE-9	Manual reset (PID group 9)	50.0		0.0 to 100.0%
53	oL-9	Manipulated variable lower limit (Output limiter group 9)	0.0		-5.0 to manipulated variable upper limit %
54	oH-9	Manipulated variable upper limit (Output limiter group 9)	100.0		Manipulated variable lower limit to +105.0%
55	P-A1	Proportional band (PID group A1)	100.0		0.0 to 1000.0% (0.0: On-off control)
56	I-A1	Integral time (PID group A1)	0		0 to 3600sec (0: no integral operation)
57	d-A1	Derivative time (PID group A1)	0		0 to 1200sec (0: no derivative operation)
58	rE-A1	Manual reset (PID group A1)	50.0		0.0 to 100.0%
59	CP-A1	Switching point (PID group A1)	1000 SPU		-19999 to +20000 SPU
60	tP-A1	Tuning point (PID group A1)	500 SPU		-19999 to +20000 SPU
61	P-A2	Proportional band (PID group A2)	100.0		0.0 to 1000.0% (0.0: On-off control)
62	I-A2	Integral time (PID group A2)	0		0 to 3600sec (0: no integral operation)
63	d-A2	Derivative time (PID group A2)	0		0 to 1200sec (0: no derivative operation)
64	rE-A2	Manual reset (PID group A2)	50.0		0.0 to 100.0%
65	CP-A2	Switching point (PID group A2)	2000 SPU		-19999 to +20000 SPU
66	tP-A2	Tuning point (PID group A2)	1500 SPU		-19999 to +20000 SPU
67	P-A3	Proportional band (PID group A3)	100.0		0.0 to 1000.0% (0.0: On-off control)
68	I-A3	Integral time (PID group A3)	0		0 to 3600sec (0: no integral operation)
69	d-A3	Derivative time (PID group A3)	0		0 to 1200sec (0: no derivative operation)
70	rE-A3	Manual reset (PID group A3)	50.0		0.0 to 100.0%
71	CP-A3	Switching point (PID group A3)	3000 SPU		-19999 to +20000 SPU
72	tP-A3	Tuning point (PID group A3)	2500 SPU		-19999 to +20000 SPU

DCP551 Parameter Work Sheet

No.	Item code	Item	Factory default- settings	User settings	Settings and descriptions
73	<i>P-A4</i>	Proportional band (PID group A4)	100.0		0.0 to 1000.0% (0.0: On-off control)
74	<i>I-A4</i>	Integral time (PID group A4)	0		0 to 3600sec (0: no integral operation)
75	<i>d-A4</i>	Derivative time (PID group A4)	0		0 to 1200sec (0: no derivative operation)
76	<i>rE-A4</i>	Manual reset (PID group A4)	50.0		0.0 to 100.0%
77	<i>CP-A4</i>	Switching point (PID group A4)	4000 SPU		-19999 to +20000 SPU
78	<i>tP-A4</i>	Tuning point (PID group A4)	3500 SPU		-19999 to +20000 SPU
79	<i>P-A5</i>	Proportional band (PID group A5)	100.0		0.0 to 1000.0% (0.0: On-off control)
80	<i>I-A5</i>	Integral time (PID group A5)	0		0 to 3600sec (0: no integral operation)
81	<i>d-A5</i>	Derivative time (PID group A5)	0		0 to 1200sec (0: no derivative operation)
82	<i>rE-A5</i>	Manual reset (PID group A5)	50.0		0.0 to 100.0%
83	<i>CP-A5</i>	Switching point (PID group A5)	5000 SPU		-19999 to +20000 SPU
84	<i>tP-A5</i>	Tuning point (PID group A5)	4500 SPU		-19999 to +20000 SPU
85	<i>P-A6</i>	Proportional band (PID group A6)	100.0		0.0 to 1000.0% (0.0: On-off control)
86	<i>I-A6</i>	Integral time (PID group A6)	0		0 to 3600sec (0: no integral operation)
87	<i>d-A6</i>	Derivative time (PID group A6)	0		0 to 1200sec (0: no derivative operation)
88	<i>rE-A6</i>	Manual reset (PID group A6)	50.0		0.0 to 100.0%
89	<i>CP-A6</i>	Switching point (PID group A6)	6000 SPU		-19999 to +20000 SPU
90	<i>tP-A6</i>	Tuning point (PID group A6)	5500 SPU		-19999 to +20000 SPU
91	<i>P-A7</i>	Proportional band (PID group A7)	100.0		0.0 to 1000.0% (0.0: On-off control)
92	<i>I-A7</i>	Integral time (PID group A7)	0		0 to 3600sec (0: no integral operation)
93	<i>d-A7</i>	Derivative time (PID group A7)	0		0 to 1200sec (0: no derivative operation)
94	<i>rE-A7</i>	Manual reset (PID group A7)	50.0		0.0 to 100.0%
95	<i>CP-A7</i>	Switching point (PID group A7)	20000SPU (fixed)		20000 SPU (tied)
96	<i>tP-A7</i>	Tuning point (PID group A7)	6500 SPU		-19999 to +20000 SPU

■ Setup data setting

No.	Item code	Item	Factory default- settings	User settings	Settings and descriptions
1	C 01	PV1 range number	0		0 to 16 : Thermocouple 48 to 52 : Linear (DC current and DC voltage) 64 to 71 : Resistance temperature detector 96 to 103 : Resistance temperature detector 128 to 134: Linear (DC current and DC voltage)
2	C 02	PV1 temperature unit	0		0 : Celsius (°C) 1 : Fahrenheit (°F)
3	C 03	PV1 decimal point position	1		0 to 2
4	C 04	PV1 linear decimal point position	1		0 to 4
5	C 05	PV1 linear range lower limit	0 PVU		−19999 to +20000 PVU(PV1)
6	C 06	PV1 linear range upper limit	10000 PVU		−19999 to +20000 PVU(PV1)
7	C 07	PV1 cold junction compensation	0		0 : Provided (Compensated inside the instrument) 1 : Not provided (Compensated outside the instrument)
8	C 08	PV1 root extraction	0		0 : Not provided 1 : Provided
9	C 09	PV1 root extraction dropout	0.2		0.2 to 10.0% (Ratio to input range)
10	C 10	PV1 cold junction bias	0.0		−1.0 to + 1.0°C
11	C 11	PV2 range number	0		0 to 16 : Thermocouple 48 to 52 : Linear (DC current and DC voltage) 64 to 71 : Resistance temperature detector 96 to 103 : Resistance temperature detector 128 to 134: Linear (DC current and DC voltage)
12	C 12	PV2 temperature unit	0		0 : Celsius (°C) 1 : Fahrenheit (°F)
13	C 13	PV2 decimal point position	1		0 to 2
14	C 14	PV2 linear decimal point position	1		0 to 4
15	C 15	PV2 linear range lower limit	0 PVU		−19999 to +20000 PVU(PV2)
16	C 16	PV2 linear range upper limit	10000 PVU		−19999 to +20000 PVU(PV2)
17	C 17	PV2 cold junction compensation	0		0 : Provided (Compensated inside the instrument) 1 : Not provided (Compensated outside the instrument)
18	C 18	PV2 root extraction	0		0 : Not provided 1 : Provided
19	C 19	PV2 root extraction dropout	0.2		0.2 to 10.0% (Ratio to input range)
20	C 20	PV2 cold junction bias	0.0		−1.0 to + 1.0°C
21	C 21	Control output system	1		0 : 5S output (Current proportional SP output) 1 : 5G output (Current proportional control output) 2 : 6D output (Voltage time proportional control output) system A 3 : 6D output (Voltage time proportional control output) system B 4 : 8D output (open collector time proportional control output) system A 5 : 8D output (open collector time proportional control output) system B
23	C 23	Control action	0		0 : PID — A reverse operation 1 : PID — A normal operation 2 : PID — B reverse operation 3 : PID — B normal operation
25	C 25	PV channel switching type	0		0 : PV1 low-temperature sensor, PV2 high-temperature sensor 1 : PV1 high-temperature sensor, PV2 low-temperature sensor 2 : PV1 tied 3 : PV2 tied 4 : Backup switching
26	C 26	PV channel switching system	0		0 : External switch switching 1 : Automatic switching (switching + dead band) 2 : Automatic switching B (switching + dead band + external switch) 3 : Automatic switching C (2-point proportional)
27	C 27	PV channel switching point	10000 PVU		−19999 to +20000 PVU(PV1)
28	C 28	PV channel switching dead band	100 PVU		1 to 1000 PVU(PV1)

denotes items settable only on models with two PV input channels.

DCP551 Parameter Work Sheet

No.	Item code	Item	Factory default-settings	User settings	Settings and descriptions
29	C 29	Selections available when power is on during PV channel switching	0		0 : Continues until power is turned off. 1 : PV1 2 : PV2 3 : High-temperature PV 4 : Low-temperature PV
30	C 30	PV equalizer	0		0 : Not provided 1 : PV1 only 2 : PV2 only 3 : Both PV1 and PV2
31	C 31	End of operation	0		0 : READY mode 1 : END mode
32	C 32	Manipulated variable in READY mode	0.0		-5.0 to +105.0%
33	C 33	Manipulated variable setting in PV overrange	0		0 : Not provided 1 : Provided
34	C 34	Manipulated variable in PV overrange	0.0		-5.0 to +105.0%
35	C 35	MANUAL change mode	0		0 : Smooth 1 : Preset
36	C 36	Preset MANUAL value	0.0		-5.0 to +105.0%
43	C 43	Service interruption time when running can be continued	0		0 to 3600sec
45	C 45	Auxiliary output 1 type	0		0 : SP 1 : PV 2 : Deviation (DEV) 3 : Manipulated variable (MV) 4 : PV1 5 : PV2
46	C 46	Auxiliary output 1 lower limit (4mA)	0 SPU		-19999 to +20000 SPU (C45 not equal to 3) -1999.9 to +2000.0% (C45 set to 3)
47	C 47	Auxiliary output 1 upper limit (20mA)	10000 SPU		-19999 to +20000 SPU (C45 not equal to 3) -1999.9 to +2000.0% (C45 set to 3)
48	C 48	Auxiliary output 2 type	0		0 : SP 1 : PV 2 : Deviation (DEV) 3 : Manipulated variable (MV) 4 : PV1 5 : PV2
49	C 49	Auxiliary output 2 lower limit (4mA)	0 SPU		-19999 to +20000 SPU (C48 not equal to 3) -1999.9 to +2000.0% (C48 set to 3)
50	C 50	Auxiliary output 2 upper limit (20mA)	10000 SPU		-19999 to +20000 SPU (C48 not equal to 3) -1999.9 to +2000.0% (C48 set to 3)
52	C 52	SP output lower limit (4mA)	0 SPU		-19999 to +20000 SPU
53	C 53	SP output upper limit (20mA)	10000 SPU		-19999 to +20000 SPU
57	C 57	Programming item Event	0		0 : Displayed 1 : Not displayed
58	C 58	Programming item PID group, output limiter group	0		0 : Displayed 1 : Not displayed
59	C 59	Programming item G.SOAK, PV shift, repeat	0		0 : Displayed 1 : Not displayed
60	C 60	Programming item PV start, cycle, pattern link	0		0 : Displayed 1 : Not displayed
61	C 61	Programming system	0		0 : RAMP-X and RAMP-T (θ) combined 1 : RAMP-X and RAMP-E (Δ SP) combined
62	C 62	Program time unit	0		0 : Hours, min (SPU/hour for RAMP-T) 1 : Min, sec (SPU/min for RAMP-T) 2 : 0.1 sec (SPU/sec for RAMP-T)
63	C 63	Time display (display panel 2)	0		0 : Remaining segment time 1 : total operation time (after READY → RUN start)
65	C 65	SP decimal point position	1		0 to 4

 denotes items settable only on models with two PV input channels.

DCP551 Parameter Work Sheet

No.	Item code	Item	Factory default- settings	User settings	Settings and descriptions
66	<i>C 66</i>	SP limit lower limit	PV1 range lower limit		-19999 to +20000 SPU
67	<i>C 67</i>	SP limit upper limit	PV1 range upper limit		-19999 to +20000 SPU
71	<i>C 71</i>	External switch input RSW5	0		0 : NOP (does not function.) 1 : RAMP—E 2 : FAST
72	<i>C 72</i>	External switch input RSW6	0		3 : G.SOAK is cleared using OR. 4 : G.SOAK is cleared using AND. 5 : MANUAL/AUTO
73	<i>C 73</i>	External switch input RSW7	0		6 : AT start /terminate 7 : PV1/PV2 8 : Auto load
74	<i>C 74</i>	External switch input RSW8	0		9 : PV1 → PV2 standby 10: PV2 → PV1 standby 11: NOP (does not function.) 12: Normal operation/reverse operation
75	<i>C 75</i>	External switch input RSW9 to 16 (program selection)	0		0 : BCD4 bit X 2 digits 1 : Binary 7 bits
76	<i>C 76</i>	Communication address	0		0 to 127
77	<i>C 77</i>	Transmission rate	0		0 : 9600bps 1 : 4800bps 2 : 2400bps 3 : 1200bps
78	<i>C 78</i>	Transmission code	0		0 : 8 bits, even parity, 1 stop bit 1 : 8 bits, no parity, 2 stop bits
79	<i>C 79</i>	Communication protocol	0		0 : CPL 1 : ST221 (no PV trend) 2 : ST221 (PV trend)
80	<i>C 80</i>	Communication method	0		0 : RS-485 1 : RS-232C
81	<i>C 81</i>	ROM ID	—		< Description > Can only be referenced for mechanical service use.
82	<i>C 82</i>	ROM ITEM	—		
83	<i>C 83</i>	ROM revision	—		
84	<i>C 84</i>	Data version	—		
85	<i>C 85</i>	CPU board ID	—		
86	<i>C 86</i>	I/O board ID	—		
90	<i>C 90</i>	PID type	1		0 : Improved 1 : Compatible with Mark I
91	<i>C 91</i>	PV1 burnout	0		0 : Provided 1 : Not provided
92	<i>C 92</i>	PV2 burnout	0		0 : Provided 1 : Not provided
93	<i>C 93</i>	Time proportional output system	0		0 : Does not go on a second time off in time proportional cycle. 1 : Goes on a second time in time proportional cycle.
95	<i>C 95</i>	Voltage output tuning	15		2 to 22 mA
97	<i>C 97</i>	Communication port	0		0 to 15 Uses back plate terminal to setting 0. Uses loader jack to setting 1 to 15.
98	<i>C 98</i>	Special function	0		0 to 255
99	<i>C 99</i>	PV1 zener barrier adjustment	—		-20.00 to +20.00
100	<i>C100</i>	PV2 zener barrier adjustment	—		-20.00 to +20.00

denotes items settable only on models with two PV input channels.

DCP551 Parameter Work Sheet

■ Constant value control data setting

No.	Item code	Item	Factory default- settings	User settings	Settings and descriptions
1	<i>ConSt</i>	Control mode	0		0 : Program run mode 1 : Constant value control mode
2	<i>SP</i>	Set point	0		Within setup <i>C66</i> to <i>C67</i> setting (SP limit)
3	<i>P</i>	Proportional band	100.0		0.0 to 1000.0% (0.0 : On-off control)
4	<i>I</i>	Integral time	0		0 to 3600sec (0: no integral operation)
5	<i>d</i>	Derivative time	0		0 to 1200sec (0: no derivative operation)
6	<i>rE</i>	Manual reset	50.0		0.0 to 100.0%
7	<i>oL</i>	Manipulated variable lower limit	0.0		-5.0 to upper limit %
8	<i>oH</i>	Manipulated variable upper limit	100.0		Lower limit to +105.0%

Revision History

Printed Date	Manual Number	Edition	Revised pages	Description
97-12	EN11-6186	1st Edition		
98-11		2nd Edition	Fly leaf 4-3 5-4 5-28 7-15 7-26 8-1 8-19 11-2 11-5 12-8 12-12 12-17	Fixed command control → Constant value control Addition of comment Compensating lead wire specifications was deleted 3rd item on NOTE Select Δ SP setting → Select θ setting Pare of Lise changed Section of Event type 89 Meaning Message" Segment number binary SEG-BIN → Segment number binary code SEG-BIN Section of "C76 Settings and descriptions" Addition of explanation NOTE was changed (CP-SP-1002E was abolished) "̀" and "̂" replaced in the character Lise Parallel connection to another instrument was deleted Section of "Communication" RA-485 specification was changed The table of Key test(00-01) was changed Figure of Table 12-9 was added Fig12-6, 12-7 was changed
00-01		3rd Edition	v 4-16 4-17 7-26 Parameter Work Sheet P.13	The Role of this Manual → Organization of This User's Manual was changed. Wiring diagram of RS-232C connection was changed. JIS code of NOTE table was deleted. Item code C90 was changed.Unused to PID type. C90 was added.
01-02		4th Edition	6-8 9-9	Normal/Reverse operation was added. Setup data C91 → C90 was changed.
01-06		5th Edition	4-6 4-16 10-9	Category 3 or higher → Less than 100Ω changed The 2nd item of "Handling Precautions", "There are four (RD, SD, SG and FG) •••" → "There are three (RD, SD and SG) •••" changed and the 3rd item of "Handling Precautions" deleted Changed description of the 3rd item of "Handling Precautions"
02-03		6th Edition	iii, 10-8 4-16	Caution of used batteries changed Changed description of the 2nd item of "Handling Precautions"
02-11		7th Edition	4-16	Corrected description of the 2nd item of "Handling Precautions"
04-02		8th Edition	4-2, 11-6, 1 to 11 4-14, 4-15 7-30	Description change based on the European standards revision CP-SP-1159E was reflected Handling Precautions added Description of C93 was corrected
04-08		9th Edition	4-3 4-9 7-30	Polyethelene insulated vinyl sheathed cable for JCS-364→JCS4364 instrument cable changed Voltage output: C91 → C95 was changed ●C95 Constant current type SSR added

HONEYWELL SERVICE CENTERS

NETHERLANDS

HONEYWELL BV
Laaderhoogtweg 18
NL-1101 EA AMSTERDAM ZO
THE NETHERLANDS
Tel.:31 20 56 56 911

POLAND

HONEYWELL Ltd
Ul Augustowka 3
PL-02981 WARSAW
POLAND
Tel.:48 2 642 25 70

REPUBLIC OF IRELAND

HONEYWELL
Unit 5
Long Mile Road
DUBLIN 12
Republic of Ireland
Tel.:353 1 565944

RUSSIA

HONEYWELL INC
Tryokhprundny Pereulok 11.13
SU 10 3001 MOSCOW
Tel.:7095 29 92 531

SOUTH AFRICA

HONEYWELL LTD
34 Harry Street
Robertsham
JOHANNESBURG 2001
REPUBLIC OF SOUTH AFRICA
Tel.:27 11 680 3440

SWEDEN

HONEYWELL A.B.
Storsatragrand 5
S-127 86 STOCKHOLM
SWEDEN
Tel.:46 8 775 55 00

UNITED KINGDOM

HONEYWELL HOUSE
Charles Square
BRACKNELL, BERKS. RG12 1EB
UNITED KINGDOM
Tel.:44 344 424 555

VENEZUELA

HONEYWELL CA
APARTADO 61314
1060 CARACAS
VENEZUELA
Tel.:58 2 239 7533

NORWAY

HONEYWELL A/S
Askerveien 61
PO Box 263
N-1371 ASKER
NORWAY
Tel.:47 66 90 20 30

PORTUGAL

HONEYWELL PORTUGAL LDA
Edificio Suecia II
Av.do Forte nr 3-Piso 3
CARNAXIDE
2795 LINDA A VELHA
PORTUGAL
Tel.:351 4172 602

REP.OF SINGAPORE

HONEYWELL PTE LTD.
BLOCK 750E CHAI CHEE ROAD
06-01 CHAI CHEE IND.PARK
1646 SINGAPORE
REP OF SINGAPORE
Tel.:65 449 7609

SLOVAK REPUBLIC

HONEYWELL
Trnavska 3
831 04 BRATISLAVA
SLOVAKIA
Tel.:42 7 601 23

SPAIN

HONEYWELL
Josefa Valcarcel, 24
PO Box 29106
28080 MADRID
SPAIN
Tel.:34 1 32 02 112

SWITZERLAND

HONEYWELL A.G.
Hertistrasse 2
8304 WALLISELLEN
SWITZERLAND
Tel.:41 1 839 2525

U.S.A

HONEYWELL INC
INDUSTRIAL CONTROLS DIV.
1100 VIRGINIA DRIVE
PA 19034-3260 FT.WASHINGTON
U.S.A
Tel.:215 641 3000

HONEYWELL SERVICE CENTERS

ARGENTINA

HONEYWELL S.A.I.C.
BELGRANO 1156
BUENOS AIRES
ARGENTINA
Tel.:54 1 383 9290

AUSTRALIA

HONEYWELL LIMITED
5 Thomas Holt Drive
North Ryde Sydney
NSW AUSTRALIA 2113
Tel.:61 2 353 7000

BELGIUM

HONEYWELL S.A.
Avenue de Schipol, 3
1140 BRUSSELS
BELGIUM
Tel.:32 2 728 27 11

CANADA

HONEYWELL LIMITED
THE HONEYWELL CENTRE
155 GORDON BAKER RD
M2H 3N7 NORTH YORK, ONTARIO
CANADA
Tel.:416 499 6111

DENMARK

HONEYWELL A/S
Lyngby Hovedgade 98
2800 LYNGBY
DENMARK
Tel.:45 45 93 56 56

FRANCE

HONEYWELL S.A.
4, Avenue Ampere
MONTIGNY LE BRETONNEUX
F-78886 ST QUENTIN EN YVELINES
FRANCE
Tel.:(1) 30 58 80 00

HUNGARY

HONEYWELL Kft
Volgy U 30
H-1026 BUDAPEST
HUNGARY
Tel.:36 1 116 76 59

JAPAN

HONEYWELL KK
14-6, Shibaura 1-chome,
Minato-ku, Tokyo 150-0023
Japan
Tel.:81-3-5440-1395

ASIA PACIFIC

HONEYWELL ASIA PACIFIC Inc.
Room 3213-3225
Sun Kung Kai Centre
No 30 Harbour Road
WANCHAI
HONG KONG
Tel.:852 829 82 98

AUSTRIA

HONEYWELL AUSTRIA G.m.b.H.
Handelskai 388
A1020 VIENNA
AUSTRIA
Tel.:43 1 213 300

BRAZIL

HONEYWELL DO BRAZIL AND CIA
Rua Jose Alves Da Chunha
Lima 172
BUTANTA
05360 SAO PAULO SP
BRAZIL
Tel.:55 11 819 3755

CZECHIA

HONEYWELL PRAGUE
Krocínovska 3
CS16000 PRAGUE 6
CZECHIA
Tel.:422 243 10 754

FINLAND

HONEYWELL OY
Ruukintie 8
SF-02320 ESPOO
FINLAND
Tel.:358 0 80101

GERMANY

HONEYWELL AG
Kaiserleistrasse 39
Postfach 10 08 65
D-63067 OFFENBACH/MAIN
GERMANY
Tel.:49 69 80 640

ITALY

HONEYWELL S.p.A.
Via Vittor Pisani, 13
20124 MILANO
ITALY
Tel.:39 2 67 731

MEXICO

HONEYWELL S.A.DE CV
AV. CONSTITUYENTES 900
COL. LOMAS ALTAS
11950 MEXICO CITY
MEXICO
Tel.:52 5 259 1966

