

Smart Field Communicator

Model: SFC160 / SFC260

User's Manual



Yamatake Corporation

Copyright, Notices and Trademarks

Printed in Japan - ©Copyright 2000 by Yamatake Corporation.

While this information is presented in good faith and believed to be accurate, Yamatake Corporation disclaims the implied warranties of merchantability and fitness for a particular purpose and makes no express warranties except as may be stated in its written agreement with and for its customer.

In no event is Yamatake Corporation liable to anyone for any indirect, special or consequential damages. This information and specifications in this document are subject to change without notice.

Preface

Thank you for purchasing the Yamatake SFC Smart Field Communicator. Designed for communication to a full range of Yamatake smart field instruments, the SFC allows you to read and set the internal data of these instruments. To obtain the best possible performance from your SFC, please be sure to read this user's manual carefully before commencing operation.

Unpacking and Storing the SFC

Unpacking

Your SFC is a precision instrument and should be handled carefully to prevent damage or breakage.

When unpacking the SFC, verify that the package contains the following items:

- The SFC
- A roll of printing paper (model SFC260 type only)
- Communication cable (with alligator clips)
- Communication cable (with hooks)
- Battery charger

An optional carrying case is available separately.

Verifying the specifications

The specifications of your SFC are written on the identification plate mounted to the SFC. Compare these specification with those given in Specification sheet (SS2-SFC100-0100), and verify that all specification on the plate are correct.

Inquiries

If you have any questions regarding the specifications of your SFC, contact your nearest Yamatake representative office or Yamatake Corporation. When making an inquiry, be sure to provide the model number and product number of your SFC.

Safety precautions

Introduction

Proper installation, operation and regular maintenance are essential to ensure safety during the use of your SFC. Don't use the SFC before completely reading and fully understanding the safety precautions described in this manual, and be sure to follow the instructions on installation, operation and maintenance.

Safety precautions

Safety precautions in this manual are of four types - Warning, Caution, Important and Note. The meaning of these title is as follows:

WARNING

Potentially hazardous situation which, if not avoided, could result in death or serious injury.

CAUTION

Failure to observe this precaution may result in a dangerous condition that could result in injury to the user or in physical damage to the device.

Important:

Indicates a procedure that must be observed in order to obtain accurate measurements. If the procedure is not observed, the result may vary considerably depending on the use of the product. In some cases, Important is equivalent to a Warning. Please confirm this with actual system in which the product is to be used.

~Note *Warns only of potential property damage.*

TIIS Intrinsically Safe Apparatus

Instruction for safety

WARNING

- The SFC is supplied in standard and intrinsically explosion-proof models. If you plan to use your SFC in an explosion-proof atmosphere, make sure that an explosion-proof inspection certificate is affixed to the back of the SFC.
- Make sure that the explosion class and ignition point class of the gas to be measured match the limits shown on the certificate.
- If your SFC does not have an explosion-proof inspection certificate, it cannot be used in an explosion-proof atmosphere.
- Do not make modifications to internal parts or wiring as this may detrimentally affect the intrinsic explosion safety of the device.

Place of use

Be sure to use your SFC in a place where the explosion class and ignition point class of the gas to be measured, as prescribed under TIIS Certification i3aG4.

System structure

The figure below shows the correct system structure to be adopted when using the SFC in an explosion-proof atmosphere.

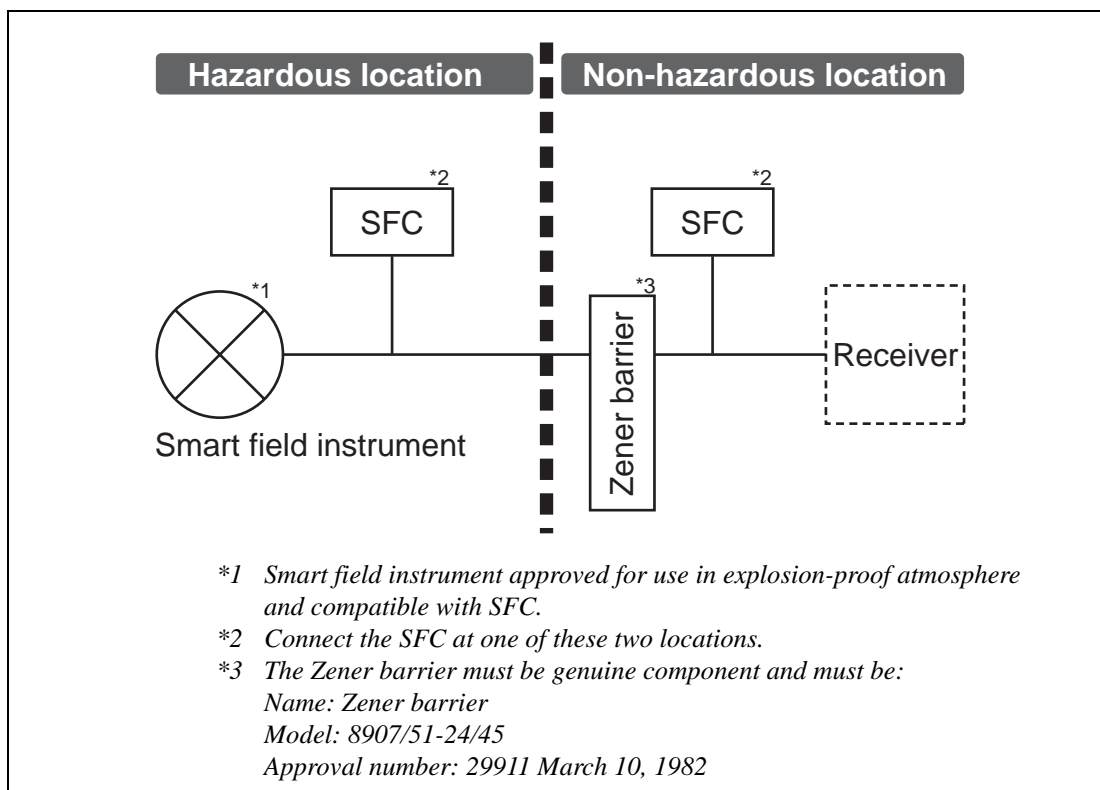

**CAUTION**

-
- The external wiring (loop) of the intrinsic safe circuit must have an inductance of 0.31 mH or less, and capacitance of 0.21 mF or less.
 - Make sure that the influence of other electrical circuits does not affect the intrinsic explosion safety of the SFC.
 - The voltage and current introduced to the receiver and the internal voltage and current of the receiver must respectively be 500 V and 35 A or less.
 - The Zener barrier must be installed in a non-dangerous location.
-

ATEX Intrinsically Safe Apparatus

Instruction for Safety

1. Introduction

Explosion protected Smart Field Communicator Model SFC160 has been constructed and certified to comply with the CENELEC standards EN 50014, EN 50020 and EN50284. Be sure to read all applicable laws of your country and local regulations for the installation of equipment for explosive atmospheres.

EN 50014, Electrical apparatus for potentially explosive atmospheres-General requirements

EN 50020, Electrical apparatus for potentially explosive atmospheres-Intrinsic safety “i”

EN 50284, Special requirements for construction, test and marking of electrical apparatus of equipment group II, category 1 G

2. Safety information

SUPPLY : 6 V DC

OUTPUT : 0 to 16mA DC

AMBIENT TEMP : -20 to +50°C

DATE : (Manufacturing date)

 0344

 II 1 G EEx ia IIC T3

KEMA 00ATEX11074 X

Special conditions for safe use (X)

- The electrical data and intrinsically safe parameters are to be referred to the description under 3. Installation, 4. Operation, 5. Maintenance and 7. Specification below.
- To avoid dangerous electrostatic charging, cleaning of the housing may only done with a damp cloth.

YAMATAKE Corporation, KANAGAWA-KEN, 253-0113, JAPAN

3. Installation

 **WARNING**

Special conditions for safe use

- The electrical data and intrinsically safe parameters are to be referred to the description under 7. Specifications below.
-

4. Operation

 **WARNING**

-1. Special conditions for safe use

The electrical data and intrinsically safe parameters are to be referred to the description under 7. Specifications below.

- 2. The battery pack Model SANYO 5N-600AA, supplied by YAMATAKE Corporation, may be used.
-

5. Maintenance

 **WARNING**

-1. Special conditions for safe use

To avoid dangerous electrostatic charging, cleaning of the housing may only be done with a damp cloth.

- 2. The battery pack Model SANYO 5N-600AA, supplied by YAMATAKE Corporation, may be used.
 - 3. The battery pack may only be changed and recharged in the non-hazardous area with the associated battery charger.
-

6. Troubleshooting

 **WARNING**

-1. Special conditions for safe use

To avoid dangerous electrostatic charging, cleaning of the housing may only be done with a damp cloth.

7. Specifications

Item	Description
Explosion protection	Intrinsic safety II 1 G EEx ia IIC T3 for ambient temperature -20 to +50°C
Electrical data and intrinsically safe parameters	U _i = 30 V, I _i = 100mA, P _i = 1.0 W C _i = negligibly small, L _i = negligibly small U _o = 7.5 V, I _o = 22mA, P _o = 40 mW C _o = 11.1 μF, L _o = 40 mH

How this manual is organized

This manual explains use of the SFC and its peripheral devices in three chapters.

Chapter	What it covers
1	This chapter describes the components of the SFC Smart Field Communicator and the names and functions of its components and keys. If you are using as SFC for the first time, read this chapter first. Also, use this chapter as a reference to confirm the functions of each key of the SFC.
2	This chapter explains how to set up the SFC before use. It also explains how to install and advance the printing paper for models fitted with a printer, how to charge and replace batteries and how to confirm the software version.
3	This chapter describes how to operate smart field instruments using the SFC. It explains how to connect the SFC to the smart field instrument and how to perform basic operations using the SFC.

Keystrokes

Each key on the SFC can be used to activate a number of functions. In order to differentiate these functions, this manual uses the following notation:

Keystroke description	Meaning
“Press the XX key”	<ul style="list-style-type: none"> • Press the XX key alone
“Press the SHIFT + XX keys”	<ul style="list-style-type: none"> • Press the SHIFT key first to display “SHIFT” on the SFC screen, then press the XX key. Do not press the SHIFT and XX keys simultaneously.

Table of Contents

Chapter 1 : Functions and Components of SFC

Overview	1-1
Introduction	1-1
1-1 : SFC Smart Field Communicator Functions	1-2
Introduction	1-2
Compatible instruments	1-2
SFC functions	1-2
1-2 : SFC Components	1-3
Diagram	1-3
Description of parts	1-4
1-3 : SFC keyboard	1-5
SFC keys	1-5
Colors categories	1-5
Basic principles of key operation	1-6
Description of key functions	1-7
Key names and function (for Green keys)	1-7
Key names and function (for Orange keys)	1-8
Key names and functions (for Yellow keys).....	1-9
Key names and functions (for Olive and White keys).....	1-11

Chapter 2 : Handling the SFC

Overview	2-1
Introduction	2-1
2-1 : Loading the printing paper	2-2
Introduction	2-2
Printer structure	2-2
Procedure	2-2
2-2 : Recharging and changing the battery	2-4
Maximum continuous hours of use	2-4
Recharging procedure	2-4
Maximum number of recharges	2-4
Changing the battery.....	2-5
Procedure	2-5
2-3 : Advancing the printer paper	2-6
When to advance the paper.....	2-6
Procedure	2-6
2-4 : Setting the time	2-7
Use of time function	2-7
When to reset the time.....	2-7
Procedure	2-7
2-5 : Checking the software version.....	2-9
When to check the software version	2-9

Table of Contents

Procedure	2-9
2-6 : Keyboard test.....	2-10
When to test the keyboard	2-10
Procedure	2-10

Chapter 3 : Operating the SFC

Overview	3-1
Introduction	3-1
3-1 : Connecting the SFC.....	3-2
How to connect	3-2
3-2 : Initiating communications - ID/DE READ	3-3
Important.....	3-3
Procedure	3-3
3-3 : Displaying Process Value - INPUT	3-5
Procedure	3-5
3-4 : Reading smart field instrument output value - OUTPUT.....	3-6
Procedure	3-6
3-5 : Outputting a fixed current from a smart field instrument	3-7
Procedure	3-7
3-6 : Printing SFC data.....	3-9
Introduction	3-9
Printout functions	3-9
Printer	3-9
3-7 : Printing smart field instrument data - PRINT	3-10
When to use.....	3-10
Procedure	3-10
3-8 : Continuous printout of SFC responses - ACT PR.....	3-11
When to use	3-11
Procedure	3-11

List of Figure

Figure 1-1	Components of SFC	1-3
Figure 1-2	Keyboard	1-6
Figure 2-1	Printer diagram.....	2-2
Figure 2-2	Charging the battery	2-5
Figure 3-1	Connecting the SFC	3-2

List of Table

Table 1-1	SFC components and descriptions	1-4
Table 1-2	SFC Green key functions	1-7
Table 1-3	SFC Orange key functions	1-8
Table 1-4	SFC Yellow key functions	1-9
Table 1-5	SFC Olive and White keys and the functions	1-11
Table 2-1	Loading the printing paper	2-2
Table 2-2	Changing the battery	2-5
Table 2-3	Advancing the printer paper	2-6
Table 2-4	Setting the time	2-7
Table 2-5	Checking the software version	2-9
Table 2-6	Keyboard test	2-10
Table 3-1	Initiating communications using ID/DE READ	3-3
Table 3-2	Displaying the measured parameter on the SFC	3-5
Table 3-3	Reading the smart field instrument output value	3-6
Table 3-4	Procedure for simulating 4 to 20mA output from transmitter	3-7
Table 3-5	Activating the configuration printout function	3-10
Table 3-6	Activating the action printout function	3-11

Chapter 1 : Functions and Components of SFC

Overview

Introduction

This chapter lists the model number of each smart field instrument with which the SFC is able to communicate and explains the operations that it allows you to perform. It also describes the components of the SFC and its keyboard.

This chapter is divided into the following three sections.

1-1 : SFC Smart Field Communicator Functions

Introduction

The SFC allows communication with Yamatake smart field instruments via the control loop line.

Compatible instruments

The SFC can be used to communicate with DE smart field instruments including the following:

- Smart ΔP/PP TransmitterST3000
- Smart Pressure-Compensation ΔP TransmitterST3000
- Smart Temperature and Pressure Compensation TransmitterST3000
- Advanced Temperature TransmitterThermoPLUS
- Smart Impression-type Liquid Level TransmitterALTJ3000
- Smart Electromagnetic Flow MeterMagneW3000
- Smart 2-Wire Electromagnetic Flow MeterSMT3000
- Smart Gas ChromatographSGC3000
- Smart Valve PositionerSVP3000

SFC functions

The SFC provides the following functions for communicating with smart field instruments:

Startup Functions

- Initiating communications
- Displaying and setting output ranges

Verification functions

- Reading actual measurement value
- Reading actual output values

Printout functions

- Printing out smart field instrument data
- Continuous printout of responses to key input

~Note *Communication functions are not impaired even if the printer function is not operational or if the printer itself is broken.*

Maintenance

- Displaying the results of smart field instrument self-diagnostics
- Reviewing the TAG number of smart field instrument self-diagnostics
- Outputting a fixed current from a smart field instrument.

1-2 : SFC Components

Diagram

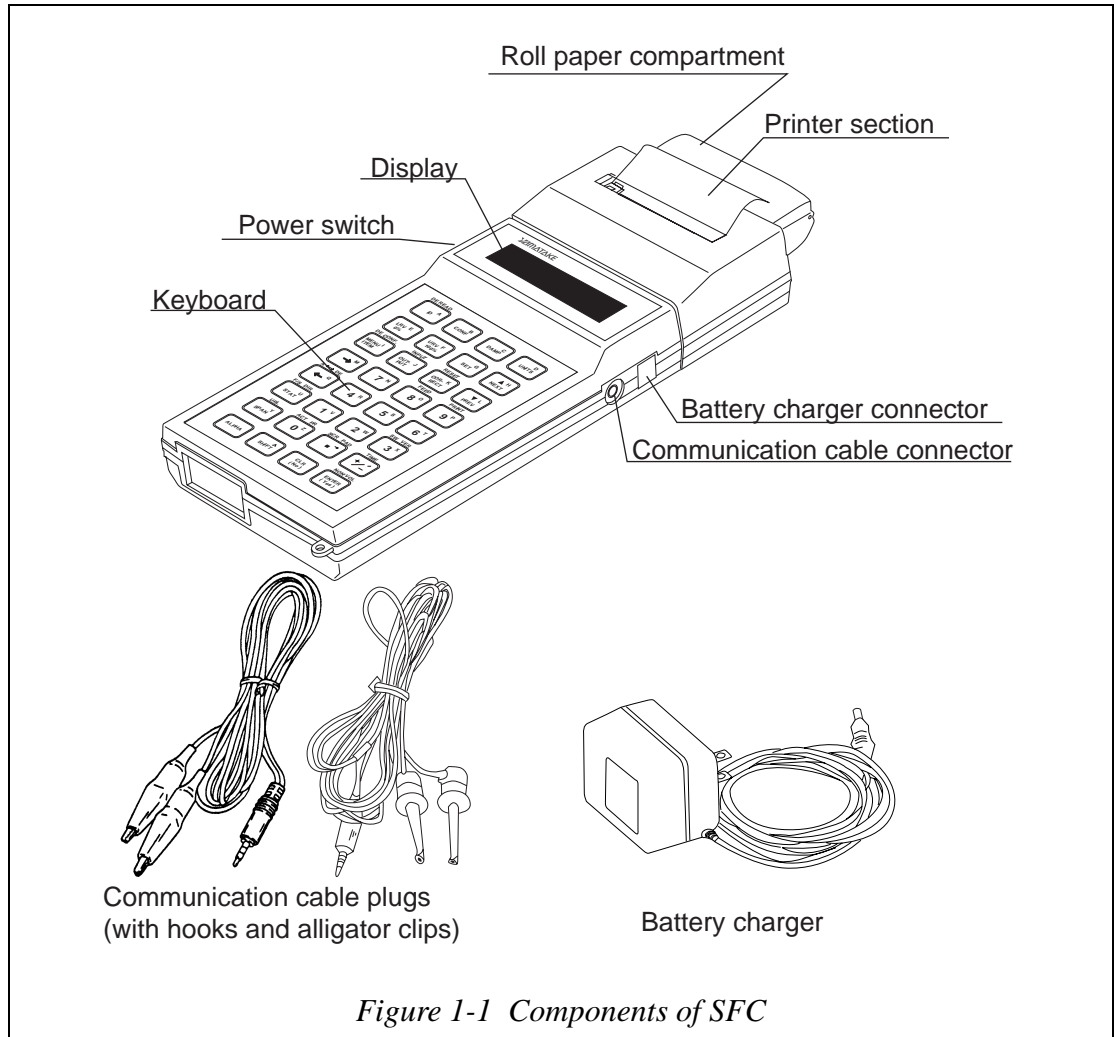

Figure 1-1 shows the components of SFC



Description of parts

Table 1-1 described the function of each component of the SFC.

Table 1-1 SFC components and descriptions

Component	Description
Paper roll compartment	<ul style="list-style-type: none"> Contains a roll of thermal printing paper. (model SFC260)
Printer unit	<ul style="list-style-type: none"> Optional Prints out 24 characters per line. Prints out smart field instrument data and communication data. Forms a single unit with the model SFC260 body and cannot be separated.
Display	<ul style="list-style-type: none"> Displays message or data from the smart field instrument in two 16-character lines.
Power switch	<ul style="list-style-type: none"> SFC self-diagnostics are automatically initiated.
Keyboard	<ul style="list-style-type: none"> Consist of 32 multifunction. Each key provides one function when pressed by itself or in sequence with proceed by  key or  key.
Communication cable socket	<ul style="list-style-type: none"> Terminal socket for communication cable jack.
Communication cable	<ul style="list-style-type: none"> Important: Always use the supplied cables only.
Battery charger socket	<ul style="list-style-type: none"> Terminal socket for battery charger jack.
Battery charger	<ul style="list-style-type: none"> For recharging the SFC battery. <p>~Note <i>Low battery voltage is indicated by a colon (:) on the display as follows:</i></p> <div style="text-align: center; border: 1px solid black; width: 150px; height: 30px; margin: 0 auto;"> <p style="text-align: center;">:</p> </div>



1-3 : SFC keyboard

SFC keys

The SFC keyboard has 32 keys with up to three functions each.

To input the character located in the upper-right corner of a key:

Press the  key to appear the cursor _ on the display, then press the desired character key.

Example: For “A”:  + 

To input a function, number or symbol located in the center of a key:

Verify that the cursor appears on the display (press the  key to switch between the X and _ cursor), then press the desired key.



Example: For “ID”  + 

To input a function labeled above a key:

Press the SHIFT key so the display reads:

SHIFT-

Then press the key corresponding to the desired function.

If you press the  key by mistake, press the  key to cancel the displayed mode.

Colors categories

The functions assigned to keys are grouped into five color-coded categories:

- Green keys: Used mainly for communicating with the Smart field instrument and for selecting readout and menu.
- Orange keys: Used mainly for communicating with the smart field instrument for setting and displaying smart field instrument parameters.
- Yellow keys: Used mainly for entering numbers.
- Olive keys: Used mainly for diagnostics and inspection.

Basic principles of key operation

Press the keys slowly and firmly. No response on the display means that the input was not successful; repeat the key operation again slowly.

Keys may be active or inactive according to the display status. If a key is inactive when pressed, no response will occur on the display, and the current function is unaffected. Verify the procedure and repeat the operation using only active keys.

SFC functions are interactive. When a screen prompt ends with a question mark (?),

the function requires to be acknowledged by pressing  key for “yes” or

 key for “no”.

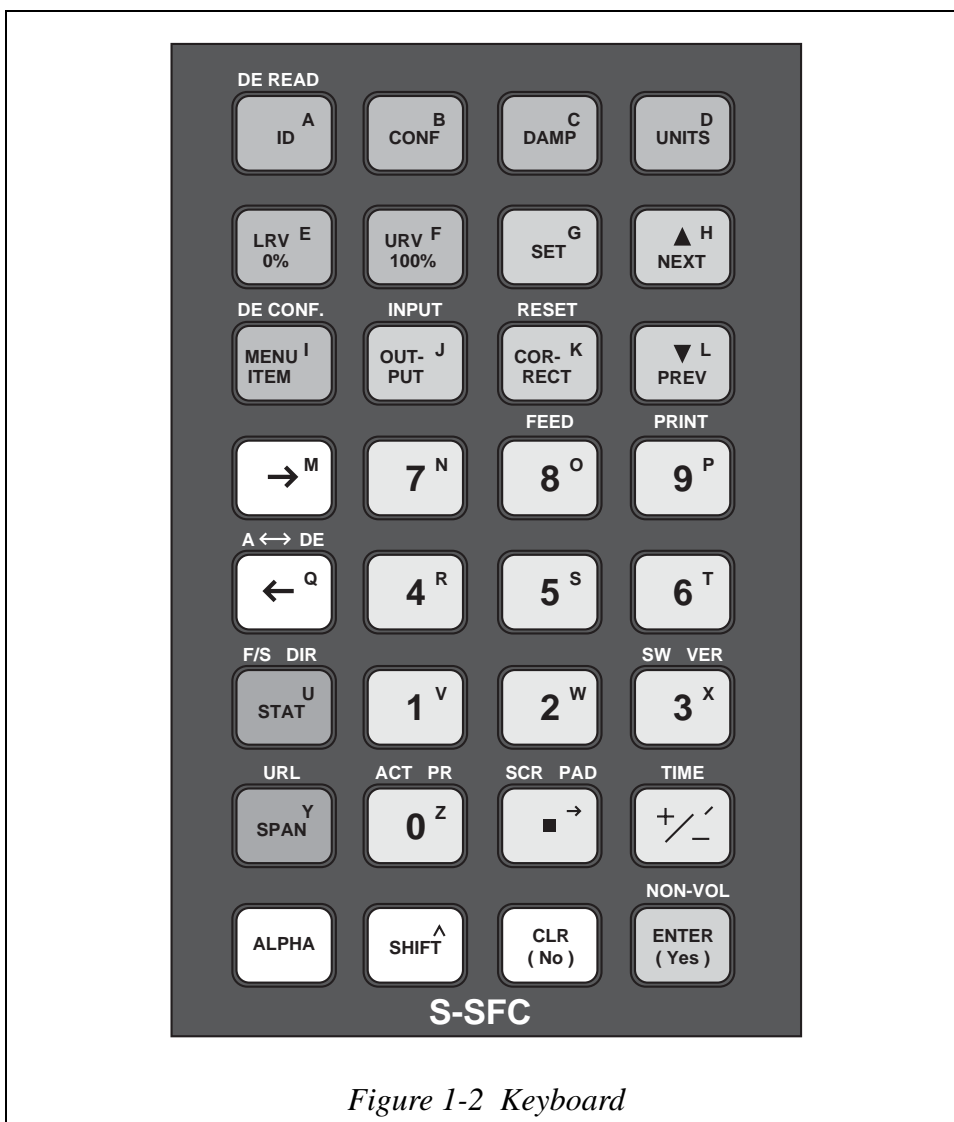









Figure 1-2 Keyboard

Description of key functions

Key names and function (for Green keys)

Table 1-2 explains the functions of the green keys used mainly for communicating with the smart field instrument and for selecting readout and menu.



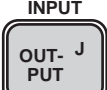

Table 1-2 SFC Green key functions

Button	Description	
	When pressed alone at cursor	When pressed after SHIFT key
	<p>ID: Starts communication with the smart field instrument. The display window shows TAG No. of the smart field instrument. It is possible to write or rewrite the TAG No. on this screen.</p>	<p>Used when the conversion output is DE. Has the same function as ID.</p>
	<p>CONF: Press this key to use a dedicated function. The dedicated functions have a hierarchical structure. Refer to Dedicated Function.</p>	<p>No effect</p>
	<p>DAMP: Press this key to display or change the damping time constant of the smart field instrument.</p>	<p>No effect</p>
	<p>UNITS: Press this key to display or set the engineering units of the flow rate measured using the smart field instrument.</p>	<p>No effect</p>
	<p>LRV 0%: Displays the Lower Range Value (LRV) of the current set value. Change the LRV on this screen.</p>	<p>No effect</p>
	<p>URV 100%: The Upper Range Value (URV) of the current set value is displayed. Change the URV on this screen.</p>	<p>No effect</p>
	<p>MENU ITEM: Used to display or select a different item located at the same hierarchy and with the same function.</p>	<p>DE CONF: Used to display or select variables output in digital communication.</p>

Key names and function (for Orange keys)

This section describes the functions assigned to the orange keys, which are mainly used to communicate with the smart field instrument or to select a screen or to select from the menu.



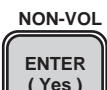

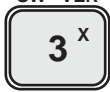

Table 1-3 SFC Orange key functions

Button	Description	
	When pressed alone at cursor	When pressed after SHIFT key
	SET: This key is used in ST3000 operation for “Zero adjustment based on actual level”.	No effect
	NEXT: Scrolls up the screen in the CONFIG function.	No effect
	PREV: Scrolls down the screen in the CONFIG function.	No effect
	OUTPUT: Displays a value in percentage, which is transmitted by the smart field instrument to the control loop.	Displays the instantaneous input measured by the smart field instrument in configuring engineering lines.
	CORRECT: Press this key to adjust the zero point of the smart field instrument. This operation is available while INPUT (input) is being read.	RESET: Restores smart field instrument internal parameters to their factory settings.
	ENTER: Press this key to answer “Yes” to a question on the screen. The screen will move one step up or down or data set by the SFC is written into the database of the smart field instrument.	NON-VOL: The data set by the SFC is forcibly written into non-volatile memory of the smart field instrument.

Key names and functions (for Yellow keys)



This section describes the functions assigned to the yellow keys which are used to enter numerals.

Table 1-4 SFC Yellow key functions

Button	Description	
	When pressed alone at cursor	When pressed after SHIFT key
PRINT 	9: Enters numeral 9.	PRINT: Prints out internal data of the smart field instrument. This printing operation is called “configuration printout”.
FEED 	8: Enters numeral 8.	FEED: Advances printing paper by 1 line. The display window shows “PRINTER FEED”. As long as this prompt is displayed, each pressing of this key advances paper by 1 line. To cancel this operation, press the CLR key.
 to 	7 to 4: Enters numeral 7 to 4.	No effect
SW VER 	3: Enters numeral 3.	Displays the software versions of the smart field instrument and SFC. If the SFC is not communicating with the smart field instrument, only the version of the SFC is shown.
	2: Enters numeral 2.	Displays “KEYBAORD TEST row* column*” and then displays the row and column of the key pressed immediately after. Used to check the keyboard for any problems. Pressing ENTER key (orange) exits KEYBOARD TEST function.
	1: Enters numeral 1.	No effect

(Continued on next page)

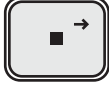





Table 1-4 SFC Yellow key functions

Button	Description	
	When pressed alone at cursor	When pressed after SHIFT key
<p>ACT PR</p> 	0: Enters numeral 0.	ACT PR: Prints out a response from the smart field instrument every time the key is operated. This operation is called “action printout”.
<p>SCR PAD</p> 	♦: Enters a decimal point.	SCR PAD: Writes a memo into the database of the smart field instrument.
<p>TIME</p> 	Inverts the sign in the case of numerical input.	TIME: Displays the current year, month, day and time.

Key names and functions (for Olive and White keys)

This section describes the functions assigned to the dark olive and white keys which are used to diagnose or check the smart field instrument or to control the keyboard, etc.

Table 1-5 SFC Olive and White keys and the functions

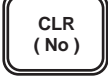
Button	Description	
	When pressed alone at cursor	When pressed after SHIFT key
	→: Moves the cursor to the right.	No effect
	←: Moves the cursor to the left.	A ↔ DE (analog ↔ digital): Switches between analog and digital communications.
	STAT: Displays self-diagnostics result of the smart field instrument.	F/S DIR: This key is not used in smart field instrument operations. Use the CONFIG function to set the failsafe direction.
	SPAN: Displays the configured span of the connected device.	URL: Displays the upper limit of the measuring range.
	ALPHA: Press this key before entering a letter of the alphabet. When the "□" cursor appears on the display section, it is ready to enter. Press this key once again to enter a function or numeral displayed in the center of each key. When the display section shows a cursor, it is ready to enter this function or numeral.	No effect
	SHIFT: Press this key to enter a function displayed above each key. When the display section shows "SHIFT-", it is ready for input.	No effect
	CLR: Clears the display in the display window and the SFC waits for input. Or press this key to answer "No" to a question on the screen. The screen moves one level up or down.	When exiting the CONFIG function, pressing this key jumps from a lower level to EXIT CONFIG at a stroke.

Chapter 2 : Handling the SFC

Overview

Introduction

This chapter explains how to handle the SFC. The procedures for inserting the printing paper roll and advancing the paper apply only to the model SFC260 (with printer).

This section is divided into six sections.

2-1 : Loading the printing paper

Introduction

This section explains how to load the roll of printing paper into the printer of an SFC with printer (model SFC260).

~Note *The standard model SFC160 does not have printer functions.*

Printer structure

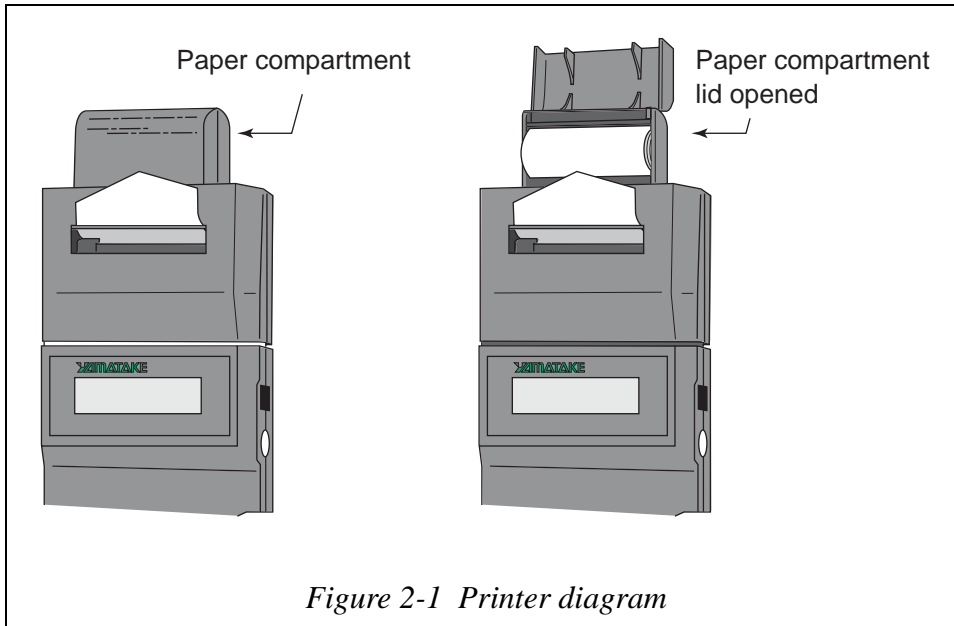

Procedure

Procedure for loading roll of printing paper.

Table 2-1 Loading the printing paper

Step	Action
1	Open the lid of the paper compartment (Figure 2-1). Hold roll of printing paper so that the end of the paper is at bottom front as shown in the drawing and insert the end of the paper into the slot of the printer. (It is not possible to print on the reverse side of the paper.) Cut the end of the paper to a triangular shaper as shown in the drawing before inserting to facilitate an easy insertion.
2	Verify that the end of the paper is engaged in the cutter and pull out about an inch of the printing paper.

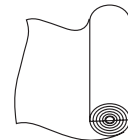

Important:

Do not pull the paper in the opposite direction of the paper flow.

(Continued on next page)

Table 2-1 Loading the printing paper

Step	Action
3	Place the paper roll in the paper compartment and close the lid.
4	Turn on the power to the model SFC260. If the printer head moves across the paper and returns, the printer functions are all normal. Then, advance the paper by one line. Perform this check each time you turn on the power to the model SFC260.

2-2 : Recharging and changing the battery

Maximum continuous hours of use

On a fully charged battery, the SFC can be operated continuously for a maximum of 24 hours. However, this time will be shorter if you use the printer frequently. When the voltage falls low the low voltage warning, a colon (:) appears on the center top line of the display.



WARNING

-
- Never recharge the battery in an explosion-proof atmosphere.
 - When a colon (:) appears in the center of the top line of the SFC display, stop using the SFC immediately and recharge the unit. Continued use of the SFC, after the colon appears will over-discharge of the SFC's internal battery and make it impossible to recharge.

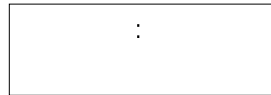

Recharging procedure

- Always use the battery charger supplied with the SFC to recharge the battery.
- Verify the commercial power supply specification of the battery charger before connecting it to the battery charger connector of the SFC.
- Insert the plug of the battery charger into a commercial power supply socket and charge the battery.

SFC batteries requires the following charging times:

- non-intrinsically explosion-proof type battery: 6 hours
- intrinsically safety (IS) explosion-proof type battery:10 hours

Important:

Overcharging the battery may shorten its service life.

Maximum number of recharges

The battery can be recharged up to 500 times.

Changing the battery

If the battery does not charge with proper charging procedures, replace it with a new battery per Figure 2-2 and Table 2-2 procedures.

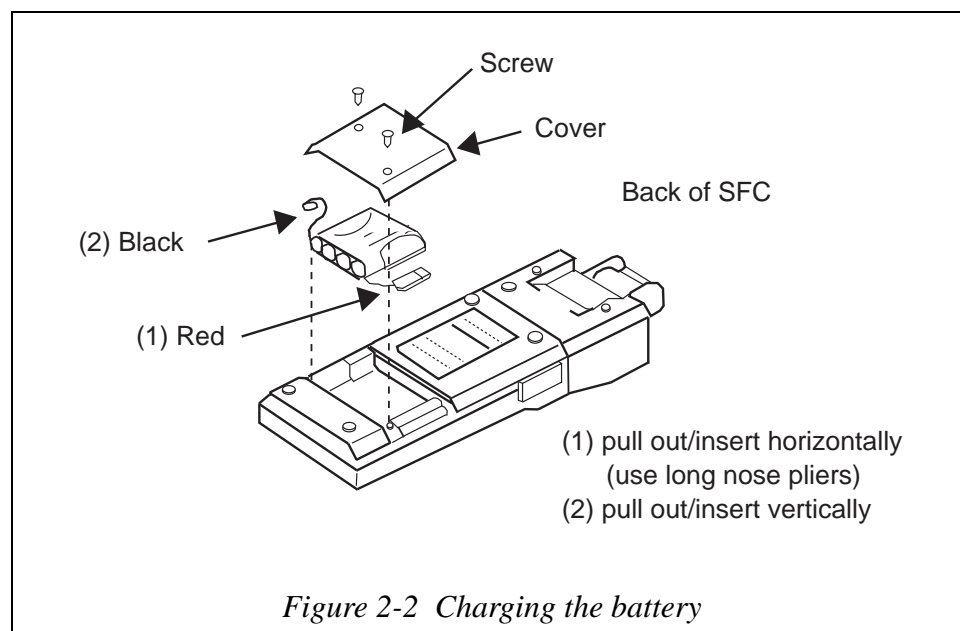

To change the battery, follow the procedure shown in the table below.

Procedure

Table 2-2 Changing the battery

Step	Action
1	Remove the two screws that secure the battery cover, located on the back of the SFC main unit. Remove the battery cover.
2	Before inserting the battery, use a long nose pliers to insert the red lead shown in Figure 2-2 into its socket in the battery holder.
3	Insert the new battery into the battery holder
4	Insert the black lead into its socket in the battery holder (note connector key)
5	Replace the battery cover and secure it with the two screws.
	<u>Important:</u> When you changed the battery, reset the date and time.

2-3 : Advancing the printer paper

When to advance the paper







This function applies only to SFC with a printer (i.e., model SFC260).

Always perform a line FEED whenever printing paper is replaced or between print functions for clarity of print.

Procedure

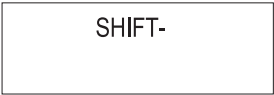
To advance the paper, follow the procedure given in the table below.

Table 2-3 Advancing the printer paper

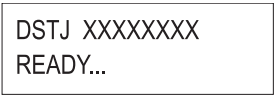
Step	Action	SFC display
1	Check that the SFC is READY If not, press the  key to place it in READY status.	
2	Press the  key.	
3	Press the  key. To advance the paper further, press the  key again.	
4	Press the  key to return to READY status.	

2-4 : Setting the time

Use of time function

For SFC's with a printer (i.e., model SFC260) only:

Use this function to set the time (year, month, day and time) that will be printed data smart field instruments, or for continuously printing responses to key input.







When to reset the time

- When the SFC is used for the first time.
- Whenever the battery is changed.

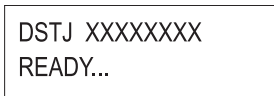
Procedure

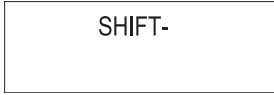

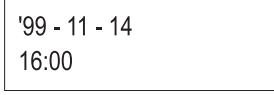
To reset the time, follow the procedure in Table 2-4.

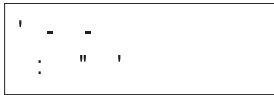
Table 2-4 Setting the time

Step	Action	SFC display
1	Verify that the communicator is in READY status. If not, press the  key to place it in READY status.	
2	Press the  key.	
3	Press the  key: <ul style="list-style-type: none"> • A readout showing the present data and time appear as shown at right. • If you do not wish to reset the time, press the  key to return to ready status. 	
4	Press the  key.	

(Continued on next page)

Table 2-4 Setting the time

Step	Action	SFC display
5	Use the numerical keys to set the data and time. YY-MM-DD; HH:MM:SS	<div style="border: 1px solid black; padding: 5px; width: fit-content;"> '99 - 06 - 15 15:50 ' 00" </div>
6	Press the  key.	<div style="border: 1px solid black; padding: 5px; width: fit-content;"> '99 - 06 - 15 15:50 ' </div>
7	Press the  key to return to READY status.	<div style="border: 1px solid black; padding: 5px; width: fit-content;"> DSTJ XXXXXXXX READY... </div>

2-5 : Checking the software version

When to check the software version







Some function of the SFC may not be available depending on the software version used. Use this function to check version of SFC software.

When communicating with a smart field instrument via the SFC, the software versions for both the SFC and the smart field instrument will be displayed.

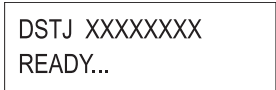
Procedure

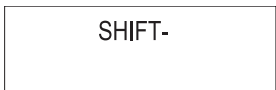
To check the software version, follow the procedure given in the table below.

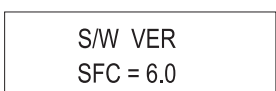
Table 2-5 Checking the software version

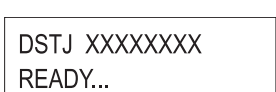
Step	Action	SFC display
1	Check that the SFC is in READY status. If not, press the  key to place it in READY status.	
2	Press the  key.	
3	Press the  key: The SFC reads the database of the smart field instrument, then displays the versions of the software being used by both the SFC and the smart field instrument.	
4	Press the  key. The readout for step 1 appears.	

2-6 : Keyboard test







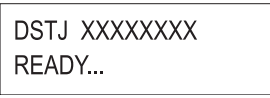

When to test the keyboard

To verify proper operation of keys of keyboard.

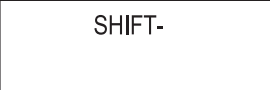
To test the keyboard, follow the procedure given in Table 2-6.

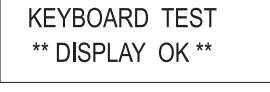
Procedure

Table 2-6 Keyboard test

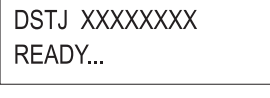
Step	Action	SFC display
1	Verify that the SFC is in READY status. If not, press the  key to place it in READY status.	
2	Press the  key.	
3	Press the  key: The SFC reads the database of the smart field instrument, then displays the versions of the software being used by both the SFC and the smart field instrument.	
4	Press any key on the keyboard. The display shows the position (row and column) of the key on the keyboard. For example, in case of  key row 8 column 3.	
5	Press the  key to exit and return to READY status.	

Chapter 3 : Operating the SFC

Overview

Introduction

This chapter explains how to operate smart field instruments via the SFC and how to print out data. It begins by explaining how to connect the SFC to a smart field instrument and then how to operate the SFC.

The SFC operation discussed is confined to basic operations, which includes:

- Initiating communications
- Displaying process input values
- Displaying output
- Outputting a fixed current
- Printing out data
- Continuous printing of responses to key input

~Note *The SFC is universal device used with a range of smart field instruments. This user's manual explains only how to operate the SFC and perform operations common to all smart field instruments. For further information on operations specific to any one smart field instrument, please refer to respective USER'S MANUAL provided with the instrument.*

3-1 : Connecting the SFC

⚠ CAUTION

- The resistance between the SFC and the loop power supply must be at least 250 for proper communication.
- Make sure that the voltage of the loop power supply does not exceed 45 V DC.

How to connect

Connect the SFC to the smart field instrument as shown in the diagram below.

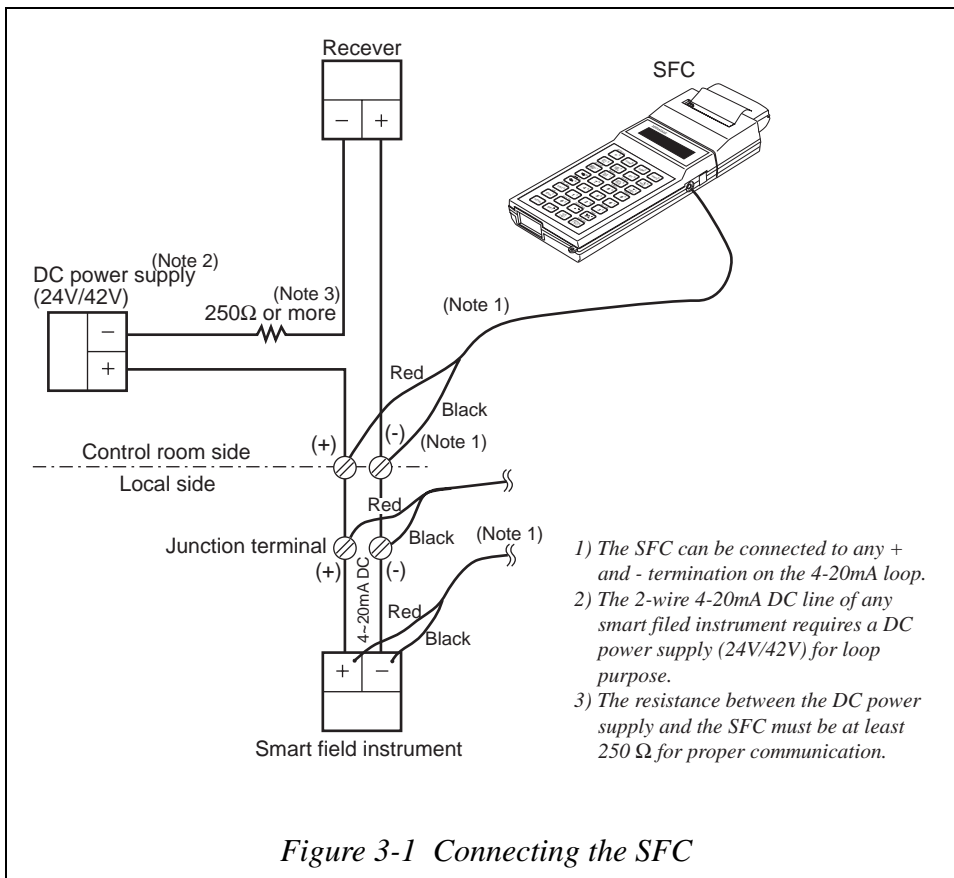

3-2 : Initiating communications - ID/DE READ



Important

Be sure to put loop in manual mode before starting communications with the smart field instrument from the SFC. This is to protect the control loop from being affected by fluctuations in analog output caused by the communication between the smart field instrument and SFC.



Procedure

Follow the procedure given in Table 3-1 to start communications with the smart field instrument from the SFC. The SFC key operations and displays will differ slightly depending on whether the output configuration of the filed instrument is digital or analog.

Table 3-1 Initiating communications using ID/DE READ

Step	Action	SFC Display
1	Verify that the transmitter is operating. If not, power the transmitter.	
2	Verify that the signal line of the transmitter and the SFC are properly connected.	
3	<p>Turn on power switch of SFC Result: SFC performs up self-diagnostics.</p> <p> WARNING</p> <hr/> <p>WARNING PROMPT TO PUT LOOP IN MANUAL IS DISPLAYED. This prompt request verification that the control loop in manual mode. The control loop may be affected by functions in analog output resulting from communications between SFC and transmitter. This is especially important if the control loop is configured with analog input.</p> <hr/> <p>Put control loop in manual and press the</p> <p> key to acknowledge.</p>	<div style="border: 1px solid black; padding: 5px; width: fit-content; margin-bottom: 10px;">SELF CHECK...</div> <div style="border: 1px solid black; padding: 5px; width: fit-content;">LOOP IN MANUAL ?</div>

(Continued on next page)







Step	Action	
4	The following readout appears <div style="text-align: center; border: 1px solid black; padding: 5px; width: fit-content; margin: 0 auto;">PRESS ID</div>	
5	<ul style="list-style-type: none"> For a digital output configuration, press the  key. <div style="text-align: center; border: 1px solid black; padding: 5px; width: fit-content; margin: 0 auto;">SHIFT-</div> <p>Then, press the  key.</p> <div style="text-align: center; border: 1px solid black; padding: 5px; width: fit-content; margin: 0 auto;">DE XMTR WORKING... -10%</div> <div style="text-align: center; border: 1px solid black; padding: 5px; width: fit-content; margin: 0 auto;">DSTJ DE TAG NO. LIN DP XXXXXXXX</div> <p>During transmission, the readout shows how much of the transmitter database has been read by the SFC</p>	<ul style="list-style-type: none"> For an analog output configuration, press the ID key. <div style="text-align: center; border: 1px solid black; padding: 5px; width: fit-content; margin: 0 auto;">TAG NO. WORKING...</div> <div style="text-align: center; border: 1px solid black; padding: 5px; width: fit-content; margin: 0 auto;">DSTJ TAG NO. LIN DP XXXXXXXX</div>
<p>Result:</p> <ul style="list-style-type: none"> If the above readout appears, communication between the SFC and the transmitter is enabled. If a TAG No. has not been entered into the transmitter, XXXXXXXX is displayed in the space for the TAG No. Go to Step 6. 		
6	Press the  key.	<div style="text-align: center; border: 1px solid black; padding: 5px; width: fit-content; margin: 0 auto;">DSTJ XXXXXXXX READY...</div>

3-3 : Displaying Process Value - INPUT

Procedure

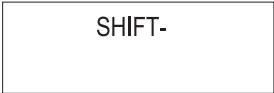
Follow the procedure given in Table 3-2 to display on the SFC the instantaneous process value measured by the smart field instrument.

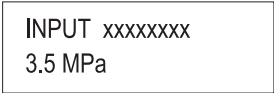
Table 3-2 Displaying the measured parameter on the SFC

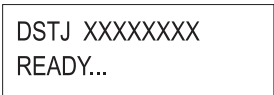





Step	Action	SFC display
1	Verify that the SFC is in READY status. If not, press the  key to place the SFC in READY status.	
2	Press the  key.	
3	Press the  key. Result: <ul style="list-style-type: none"> The readout on the right appears showing the instantaneous measured parameter (INPUT) in engineering units. 	
4	After reading the instantaneous INPUT, press the  key to exit input read mode. Result: <ul style="list-style-type: none"> Exit input read function and return to READY mode. 	

3-4 : Reading smart field instrument output value - OUTPUT

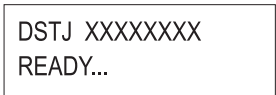
Procedure

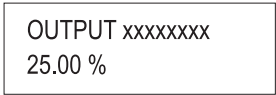
Follow the procedure given in Table 3-3 to display the current output value of the smart field instrument on the SFC.

Table 3-3 Reading the smart field instrument output value

Step	Action	SFC display
1	Verify that the SFC is in READY status. If not, press the  key to place the SFC in READY status.	
2	Press the  key. Result: <ul style="list-style-type: none"> The display on the right appears indicating the output value in percent (%) of the transmitter. 	
3	After reading the output value, press the  key to exit  read mode. Result: <ul style="list-style-type: none"> Exit OUTPUT read function and return to READY mode. 	







3-5 : Outputting a fixed current from a smart field instrument

Procedure

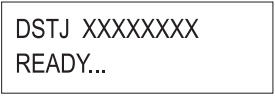
You can set the smart field instrument to output a fixed current between 4mA (0%) to 20mA (100%). This function can be used to perform loop check or verification.

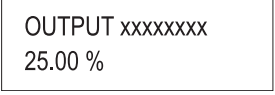
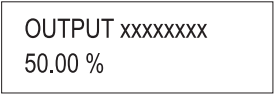
To set fixed current mode, follow the procedure given in Table 3-4.

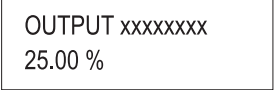
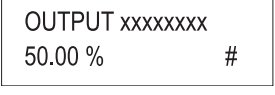
Table 3-4 Procedure for simulating 4 to 20mA output from transmitter

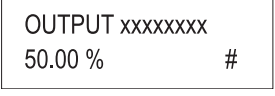
Step	Action	SFC display
1	Verify that the SFC is in READY status. If not, press the  key to place the SFC in READY status.	
2	Press the  key. Result: <ul style="list-style-type: none"> The current output value from the smart field instrument is displayed. 	
3	Use the numeric keys to enter the desired output value in percent output (i.e., 25.00).	
4	Press the  key. Results: <ul style="list-style-type: none"> The transmitter sends the corresponding output signal to the loop. The second row of the display shows a # symbol to indicate an error that transmitter is in OUTPUT mode. 	 
5	To exit fixed current output mode, press the  key again. Result: The present fixed current value is displayed.	

(Continued on next page)

Table 3-4 Procedure for simulating 4 to 20mA output from transmitter

Step	Action	SFC display
6	Press the  key. Results: <ul style="list-style-type: none"> • Fixed current output mode is canceled. • The # symbol disappears from the display. 	<div style="border: 1px solid black; padding: 5px; margin-bottom: 10px;"> OUTPUT xxxxxxxx WORKING... </div> <div style="border: 1px solid black; padding: 5px;"> DSTJ xxxxxxxx READY... </div>

3-6 : Printing SFC data

Introduction

The function available only in SFC with a printer (i.e., model SFC260) allows printing data configuration of a smart field instrument or responses from smart field instrument for entries in SFC. The two printout functions are defined below.

Printout functions

Configuration printout or data printout:

An SFC with printer is capable of printing a range of smart field instrument data including the TAG No., range, input values, output values.

This type of printout is known as a configuration printout or a data printout.

Action printout or continuous printout:

An SFC with printer is capable of continuously printing smart field instrument responses to SFC key operations. This type of printout is known as an action printout or a continuous printout.

Printer

A 24-character per line printer is available as an option with the SFC. When the printer is mounted, turning the power switch on the SFC automatically turns on the printer. The printing head passes across the paper, return to its original position and stops. The paper also advances a short distance (about 5 mm, 0.2 in.)

3-7 : Printing smart field instrument data - PRINT





When to use

Use the configuration printout (data printout) function to print out smart field instrument data such as the damping time constant and the low-flow cut-off value.

Procedure

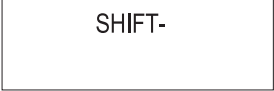
Use the procedure given in Table 3-5 to activate the configuration printout function:

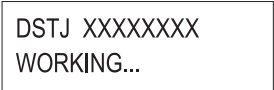
Table 3-5 Activating the configuration printout function

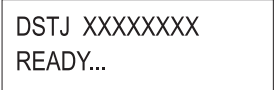
Step	Action	SFC display
1	Start communications with the smart field instrument from the SFC. For details on the procedure, see 3-2 : “Initiating communications - ID/DE READ” on page 3-3.	
2	Press the  key.	
3	Press the  key. Result: Configuration printout starts.	 
4	When printing is completed, press the  key. Result: The readout for step 2 reappears on the display.	

3-8 : Continuous printout of SFC responses - ACT PR







When to use

Use the action printout (continuous printout) function for printing out SFC responses to SFC key operations on a continuous basis.

Procedure

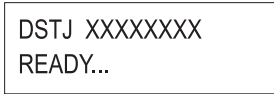

Use the procedure given in Table 3-6 to activate the continuous printout function:

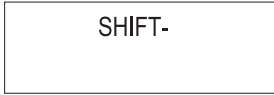
Table 3-6 Activating the action printout function

Step	Action	SFC display
1	Start communications with the SFC from the SFC. For details on the procedure, see 3-2 : “Initiating communications - ID/DE READ” on page 3-3.	
2	Press the  key.	
3	Press the  key.	
4	Press the  key. Result: The following is printed: * ACTION PRINT * START TAG No. XXXXXXXX ‘99. 01-01 01:01 and action printout starts. SFC key operations and smart field instrument responses are continuously printed.	
5	To stop the action printout operation, press the  key.	

(Continued on next page)

Table 3-6 Activating the action printout function

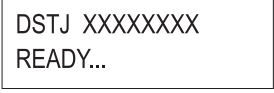
Step	Action	SFC display
6	Press the  key.	
7	Press the  key. <u>Result:</u> The following is printed: * ACTION PRINT * END The action printout function is terminated and returns to READY mode.	

Document Number:	CM2-SFC100-2001
Document Name:	SFC Smart Field Communicator Model: SFC160/SFC260 User's Manual
Date:	Oct. 1994 (First issue) Dec. 2002 (Rev.3)
Issued/Edited by:	Yamatake Corporation

Yamatake Corporation

Totate international Building
2-12-19 Shibuya
Shibuya-ku, Tokyo 150-8316
Japan

Tel : 81-3-3486-2310

Fax : 81-3-3486-2593

YAMATAKE
Savemation

Saving through Automation