



SMART TERMINAL EST240Z

User's Manual DMC10 Package

Thank you for purchasing the DMC10Package for the EST240Z. This manual contains information for ensuring correct use of the EST240Z. It also provides necessary information for installation, maintenance, and troubleshooting. This manual should be read by those who design and maintain devices that use the EST240Z. Be sure to keep this manual nearby for handy reference.

Yamatake Corporation

RESTRICTIONS ON USE

When using this product in applications that require particular safety or when using this product in important facilities, pay attention to the safety of the overall system and equipment. For example, install fail-safe mechanisms, carry out redundancy checks and periodic inspections, and adopt other appropriate safety measures as required.

REQUEST

Ensure that this User's Manual is handed over to the user before the product is used.

Copying or duplicating this User's Manual in part or in whole is forbidden. The information and specifications in this User's Manual are subject to change without notice.

Considerable effort has been made to ensure that this User's Manual is free from inaccuracies and omissions.

If you should find any inaccuracies or omissions, please contact Yamatake Corporation.

In no event is Yamatake Corporation liable to anyone for any indirect, special or consequential damages as a result of using this product.

©2001 Yamatake Corporation ALL RIGHTS RESERVED

The smart terminal[®] is a registered trademark of Yamatake Corporation. Other company names and product names listed in this manual are registered trademarks or trademarks of respective companies.

The Role of This Manual

Outline of EST240Z Manuals

The following 8 manuals are provided to cover a range of EST240Z-related topics. Use the manual that best fits your application. In the event such a manual is not available, contact us or your local EST240Z dealer.

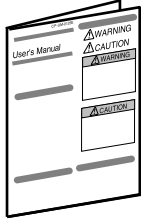

Smart Terminal EST240Z User's Manual Manual No. CP-UM-5145E

This manual is packaged with the EST240Z body.

This manual should be read by those who produce units that use the Smart Terminal.

This manual contains safety precautions when using the Smart Terminal, installation methods, and descriptions for wiring the power supply and signal lines.

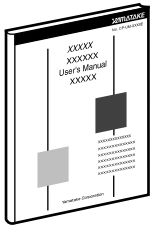

Smart Terminal EST240Z User's Manual Installation

Manual No. CP-SP-1065E

This manual should be read by those who use the EST240Z to design units and those in charge of maintenance.

This manual describes safety cautions when using the Smart Terminal, how to install for incorporating into units, wiring methods, maintenance and inspection, troubleshooting, and hardware specifications.

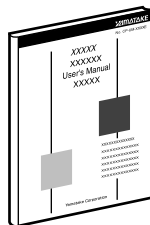

Smart Terminal EST240Z User's Manual Application Preparation

Manual No. CP-SP-1088E

This manual should be read by those who design screens that are displayed on the EST240Z and operations.

This manual describes the environment of the personal computer on which AP Editor can be used, installation methods, startup, system settings, file operations, printing, how to paste smart objects, and other AP Editor operations.

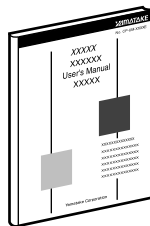

Smart Terminal EST240Z User's Manual Smart Object Library

Manual No. CP-SP-1089E

Graphic elements that have functions for displaying on the EST240Z are called "smart objects."

This manual describes the concept of smart objects and the functions of each smart object.

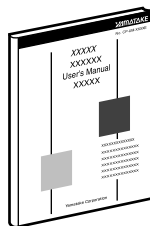

Smart Terminal EST240Z User's Manual Communications Connection

Manual No. CP-SP-1090E

This manual.

This manual should be read by those who combine the EST240Z with PLCs made by other manufacturers and dedicated board computers to build systems. This manual describes how to connect to PLCs, address maps that correspond to PLCs, how to paste smart objects, drawing, and other operations and settings required for making applications using PLCs.

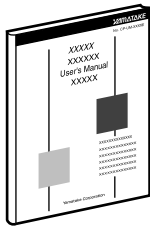

**Smart Terminal EST240Z User's Manual
DMC10 Package**

Manual No. CP-SP-1091E

This manual.

This package is used when constructing systems by connecting the EST240Z to Yamatake's Distributed Multi-channel Controller DMC10.

This manual describes the specifications of the software package, how to use the package, how to install the software, and how to operate the software.

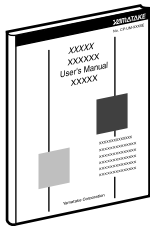

**Communication Controller CMC10B (CPL/CPL Converter)
User's Manual (Design Manual)**

Manual No. CP-SP-1064E

This manual is required reading for those who use the CMC10B, those who design hardware for integrating the CMC10B into operator control panels, those who carry out maintenance, and those who operate instruments in which the CMC10B is integrated.

It describes an outline of the CMC10B, how to install and wire for integrating the CMC10B into other devices, communications functions, troubleshooting and specifications.

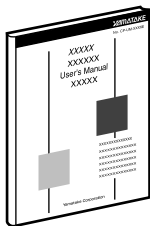

Distributed Multi-channel DMC10 Description of Functions

Manual No. CP-UM-5143E

This manual describes the product body and the exclusive Smart Loader Package SLP-D10.

This manual describes an outline of the DMC10, how to install the DMC10 for building it into instrumentation, how to wire, maintenance and inspection, how to remedy trouble that may occur, function specifications, how to install the Smart Loader Package SLP-D10, operations on the personal computer, each of the functions and how to setup.

Organization of This User's Manual

This manual is organized as follows.

Chapter 1. SYSTEM CONFIGURATION

This chapter describes the system configuration of the EST240Z with a modular type controller DMC10 when using the Package.

Chapter 2. FUNCTIONAL OUTLINE

This chapter describes the outline of the various functions of the Package.

Chapter 3. COMMUNICATION CONNECTIONS

This chapter describes how to connect the EST240Z, the DMC10, and the CMC10B. For further details, see also the manuals of the DMC10 and the CMC10B.

Chapter 4. COMMUNICATION SETUP

This chapter describes the communication parameters and how to configure the communication addresses.

Chapter 5. HOW TO USE THE PACKAGE

This chapter describes how to install the Package and how to download it to the EST240Z, in addition to providing information on configuration that should be performed before using the Package. Be sure to read this chapter and perform the necessary configuration before using the Package.

Chapter 6. DMC10 SETUP AND MONITORING

This chapter describes items that can be setup and monitored using the Package during operation, and provides screen flows diagrams.

Chapter 7. USAGE EXAMPLES - GATEWAY AND CONTROL SWITCH

This chapter describes data exchange with the PLC using the gateway function of the EST240Z, and RUN/READY change of the DMC10 using the control switch.

Chapter 8. COMBINED USE WITH USER APPLICATION

The Package can be used with a user-application created by the user. This chapter describes how to use the Package with a user-application.

Chapter 9. TROUBLESHOOTING

This chapter describes how to remedy problems that might occur.

Contents

The Role of This Manual	
Organization of This User's Manual	
Conventions Used in This Manual	

Chapter 1. SYSTEM CONFIGURATION

■ Direct link and CMC link	1-1
■ User Application and the Package	1-3
■ Caution with respect to the version of CMC10B and DMC10.....	1-3

Chapter 2. FUNCTIONAL OUTLINE

■ Direct link and CMC link	1-1
■ Auto Device Assignment.....	2-1
■ Configuration Function	2-2
■ Monitor Function.....	2-3
■ Control Switch	2-5
■ Configuration Setup	2-6

Chapter 3. COMMUNICATION CONNECTIONS

■ Direct link.....	3-1
■ CMC link	3-1

Chapter 4. COMMUNICATION SETUP

■ Configuration of the Communication Parameters.....	4-1
■ Configuration of the Communication Addresses	4-2

Chapter 5. HOW TO USE THE PACKAGE

5-1 Install the Package to the PC	5-5
5-2 Download the Package to EST240Z.....	5-2
■ Download the Package only	5-2
■ Download the User Application and the Package	5-4
■ Download User-data of the Package	5-7
■ Upload User-data of the Package	5-9
5-3 Configuration Setup of the Package.....	5-11
■ Start Up the Package	5-11
■ Auto Device Assignment	5-14
■ Name Configuration	5-16
■ Display Configuration.....	5-17
■ CMC Buffer Configuration (CMC link version only)	5-22
■ Alarm Definition	5-23

Contents

Chapter 6. DMC10 SETUP AND MONITORING

- DMC10 Setup 6-1
- DMC10 Parameters..... 6-9
- DMC10 6-12
- DMC10 Alarm Monitor 6-17

Chapter 7. USAGE EXAMPLES - GATEWAY AND CONTROL SWITCH

- PLC Data Exchange with the EST240Z Gateway Function 7-1
- Control DMC10 using the Control Switch 7-5

Chapter 8. COMBINED USE WITH USER APPLICATION

..... 8-1

Chapter 9. TROUBLESHOOTING

- Package Troubleshooting..... 9-1
- DMC10 Troubleshooting 9-2

Conventions Used in This Manual

The following conventions are used in this manual.



Handling Precautions

: Handling Precautions indicate items that the user should pay attention to when handling the **DMC10 Package**.



Note

: Notes indicate useful information that the user might benefit by knowing.

(1), (2), (3)

: Circled numbers indicate steps in a sequence or indicate corresponding parts in an explanation.

Chapter 1. SYSTEM CONFIGURATION

■ Direct link and CMC link

The DMC10 Package (hereinafter referred to as the Package) software is available in two versions, Direct link version and CMC link version. The user should select the appropriate one according to their application.

The direct link version is used when the number of DMC10 units to be connected is 15 or less and the EST240Z and the DMC10 are to be connected directly.

The CMC link version is used when the number of DMC10 units to be connected is 16 or more. In this case, the EST240Z and the DMC10 are connected via a CMC10B. A maximum of 8 CMC10B units can be connected to the EST240Z and a maximum of 15 DMC10 can be connected to each CMC10B. A group of one CMC10B and the DMC10 units that are connected to it are called one "unit".

! Handling Precautions

The event-output-module DMC10E is not counted in the number of units connected to the DMC10.

● System configuration of Direct link

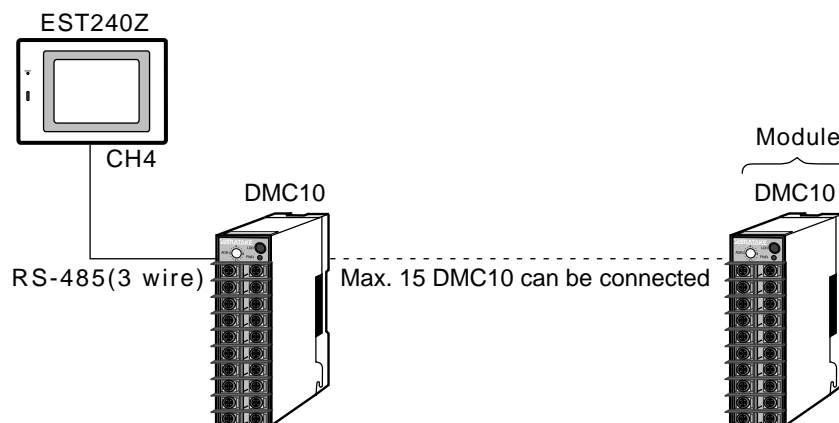

! Handling Precautions

- The DMC10 should be connected to CH4 of the EST240Z. CH1 to CH3 can not be used.
- When connecting the DMC10 to CH4 of the EST240Z, other equipment can not be connected to this port.

● System configuration of CMC link

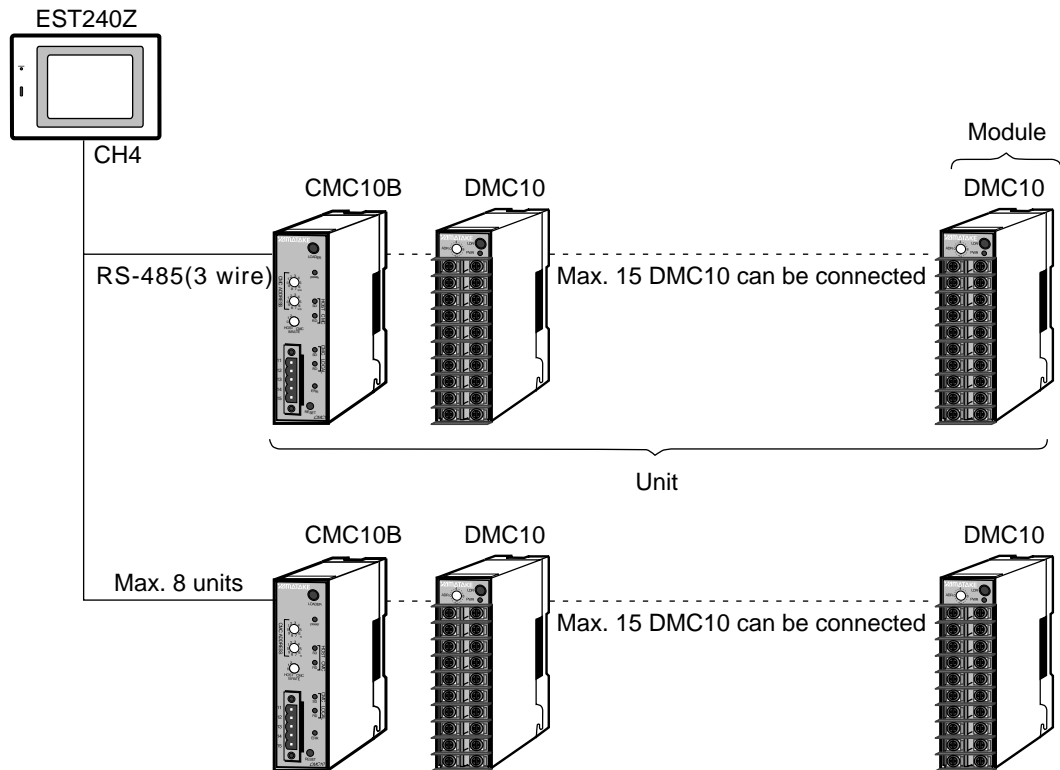

! Handling Precautions

- CMC10B should be connected to CH4 of the EST240Z. CH1 to CH3 can not be used.
- When connecting the CMC10B to CH4 of the EST240Z, other equipment can not be connected to this port.
- The configuration of the CMC10B such as Folder and Buffering configuration are done automatically by the Package when Auto device assignment is performed. Configuration such as Buffering data definition can not be performed by the user. Do not change the configuration of the CMC10B after performing Auto device assignment. For the details of Auto device assignment, see "5-3 Configuration Setup of the Package" (p.5-11).

📖 Note

The explanation in this manual is common to both the Direct link version and CMC link version. The screen examples are that of the CMC link version, and where there is any difference between two versions, it is explained each time.

■ User Application and the Package

The user can use a User Application along with the Package.

For information on how to create a User Application, see the following manual:

EST240Z Application User's Manual (Manual No. CP-SP-1088E).

When operation starts after both the User Application and the Package have been downloaded, the No.1 screen (Panel 1) of the User Application starts first.

A Panel change switch (dedicated package change) should have been included in the User Application in advance.

For details, see Chapter 8. "COMBINED USE WITH USER APPLICATION".

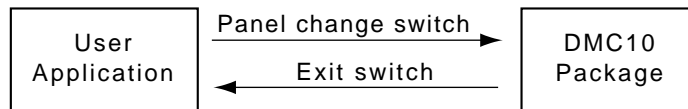

■ Caution with respect to the Version

Depending on the version of the CMC10B and the DMC10, the Package may not be able to be used, or only limited functionality may be available.

● CMC10B:

When the version of the CMC10B's ROM is 2.X or less, the Package cannot be used. The Package can only be used with the versions 3.1, or later.

The version of the ROM can be checked as follows using the CMC10B's PC loader SLP-CM1:

[Setup] - [Option] - [Others] - [ROM version]

● DMC10:

When the EST information of the DMC10 is [1], the Package cannot be used.

The EST information can be checked as follows by the DMC10's PC loader SLP-D10:

[Sepup] - [Standard] - [Information] - [EST Information]

! Handling Precautions

When the EST information of the DMC10 is [2] or [3], the following functions cannot be used. They are only available on units with [4] or higher.

- Event special
- Output Assign
- RSW special
- RSW Input
- Write to Comm.DI1 to DI4 by Gateway function

Chapter 2. FUNCTIONAL OUTLINE

This chapter describes the outline of the various functions of the Package.

■ Auto Device Assignment

The Package determines how many CMC10B and DMC10 units are connected to the EST240Z and automatically performs the device assignment. Information such as the model No. of the DMC10, which options are used, the PV input parameters, etc, are registered to the EST240Z by the Auto Device Assignment. Auto Device Assignment must be performed when starting up the system.

■ Configuration Function

The parameters that are necessary for general use of the DMC10 can be configured by the Package.

The following is a list of such parameters.

They are almost the same as those set by the user's level "L2" of the PC loader.

Functions	Type	Item	Remarks
Standard	PV inputs	Input type	
		Decimal point position	
		PV range low limit	
		PV range high limit	
		PV bias	
		SP low limit	
		SP high limit	
	Control outputs	Control output	
		Control action	
		Time proportional cycle	
		Operation at AUTO/MANUAL change	
		Pre-set manual value	
		Output at Ready	
		Position proportional control parameter	*4
	SP / Control parameter	SP	
		Proportional band (P)	
		Integral time (I)	
		Derivative time (D)	
Manual reset (RE)			
Differential (DIFF)			
Option	Event output	Type	
		Channel	
		Event Value (Main)	
		Event Value (Sub)	
		Hysteresis	
		Direct/Reverse	
		Standby	
		Output assignment	*1
		Logic	*1
		ON delay time	
		OFF delay time	
	CT Input	Waiting time before measuring	
	RSW input	Type	
		Channel	
		Input assignment	*1
		Logic	*1
		Direct/Reverse	
	AUX. output	Type	
		Channel	
		Value at 0% output	
		Value at 100% output	
Special functions	Multiple SP		
	Event special	*1	
	RSW special	*1	
	Remote SP	*1, *3	
	Heat/Cool	*1, *2, *3	
	Position Proportional Control	*2, *4	

- *1 These functions are not available when the EST information of the DMC10 is [2] or [3]. For details, see "Chapter 1. Caution with respect to the Version (p. 1-3)".
- *2 Display only. Setting is not possible.
- *3 DMC10D (High function model) only.
- *4 Only applicable for DMC10 units which have Position Proportional made (EST information of the DMC10 is 5, or later).

■ Monitor Function

The Package has the following Monitor functions.

● Module Monitor

Monitors one DMC10 module at a time. The following functions are available:

- PV monitor
- SP monitor/change
- MV monitor/change (in MANUAL mode)
- RUN/READY status monitor/change
- AUTO/MANUAL mode monitor/change
- AT status monitor/change
- LOCAL/REMOTE status monitor/change
- input/output monitor
- alarm monitor
- basic trend of PV&SP or PV&MV

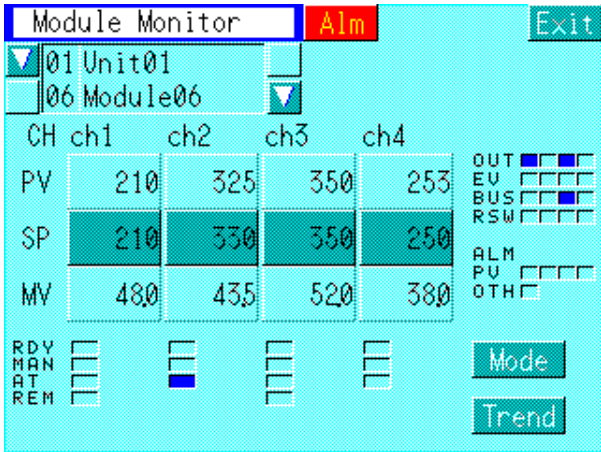

Touch [MODE] to go to [MODE]-change screen.
 Touch [TREND] to go to the Basic trend screen.
 For details, see Chapter 6 "DMC10 SETUP AND MONITORING".

● **Group Monitor**

Monitors 4 DMC10 modules at a time. The modules must have consecutive communication addresses and be in the same unit to appear on the same screen. 2 items that are selected from the following list of items can be monitored by one screen, and a maximum of four screens can be defined.

PV, SP, MV, CT, SP Sel, AUTO/MANUAL, RUN/READY, LOCAL/REMOTE, AT status.

Group Monitor					
01 Unit01		03-04			
01-02	PV	SP	03-04	PV	SP
U_H1	203	200	M_H4	250	250
U_H2	208	200	M_H5	252	250
U_H3	200	200	L_H1	270	270
U_H4	198	200	L_H2	271	271
M_H1_1	249	250	L_UP1	300	300
M_H1_2	250	250	L_UP2	301	300
M_H2	250	250	M_UP	300	300
M_H3	253	250	U_UP	298	300

● **SP/PV Monitor**

Monitors the PV and SP of any two DMC10 modules chosen by the user.

SP/PV Monitor				
01 Unit01		CH	PV	SP
<input type="checkbox"/>	U_H1		203	200
<input checked="" type="checkbox"/>	U_H2		208	200
<input type="checkbox"/>	U_H3		200	200
<input type="checkbox"/>	U_H4		198	200
03 Unit03			PV	SP
<input checked="" type="checkbox"/>	U_H1		203	200
<input checked="" type="checkbox"/>	U_H2		208	200
<input type="checkbox"/>	U_H3		200	200
<input type="checkbox"/>	U_H4		198	200

● Alarm Monitor

The Package monitors the alarm status of all the connected DMC10 units. On the Module monitor screen, Group Monitor Screen, SP/PV monitor screen, and the Control switch screen (described below), the "ALARM" lamp indicates whether alarms are occurring. The "Alarm List" screen and "Alarm Mod Detail" screen are also provided. The user can add user-set events as alarms, in addition to the PV input alarm, device alarm and communications error alarm.

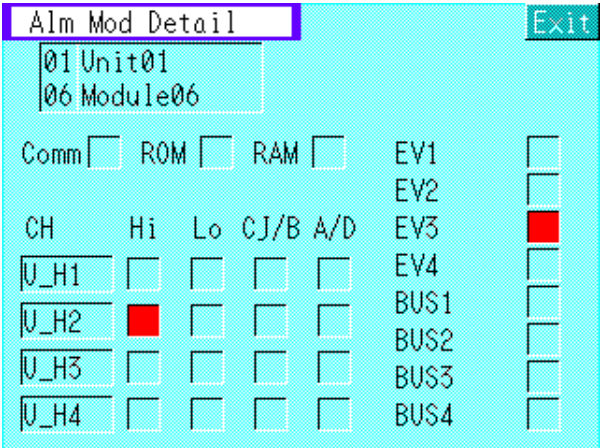

■ Control switch

The Control switch enables the user to select a DMC10 channel and change a group of SPs with one operation, or to change the modes such as RUN/READY, AUTO/MANUAL, AT-stop/-start with one operation. The user can define up to 8 control switches.

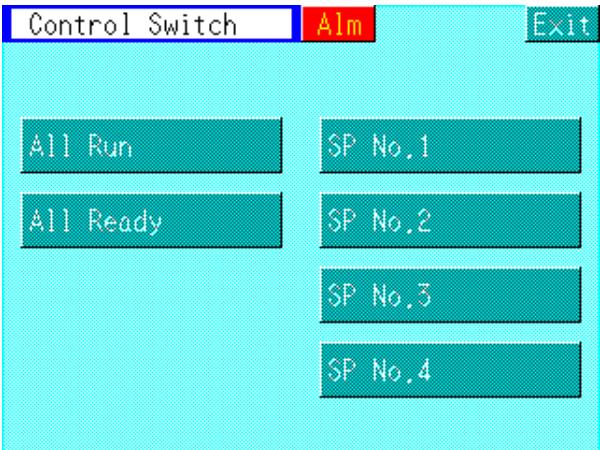

■ Configuration Setup

The user can set the configuration according to the application.

● Name Configuration

Unit name, module name, and CH name can be configured for the CMC10B and DMC10 units which were registered by the Auto device assignment. (The unit name can be set only with the CMC link version.)

The initial names are Unit01, Module01, ch1, etc.

● Display Configuration

Unused functions can be deleted from the menus on the screen.

Functions such as SP change and Mode change can be disabled.

● CMC Buffer Configuration(CMC link version only)

In the CMC link version, the user can get the CMC10B to perform cyclic reads of the data in the DMC10, such as PV, SP, etc., in addition to what is displayed on the screen.

This function makes the Gateway function of the EST240Z effective.

● Alarm Definition

The Package monitors DMC10 alarms such as PV input alarm, device alarm, and communications alarm.

The user can add the user-defined DMC10 events to the alarms.

Chapter 3. COMMUNICATION CONNECTIONS

■ Direct link

EST240Z

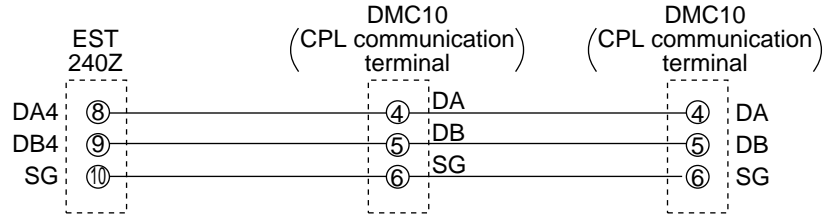

! Handling Precautions

- When linking two or more DMC10's, ensure that the communications disconnection switch is set to the "CONNECT ←" side. (Factory default)
In this case, wiring is not necessary.
For details, refer to the following manual.
Distributed Multi-channel Controller DMC10 Description of Functional Manual (Manual No. CP-UM-5143E)
- The DMC10 has a built-in resistance equivalent to a terminator.
Do not connect an external terminating resistor.

■ CMC link

● Connecting EST240Z and CMC10B

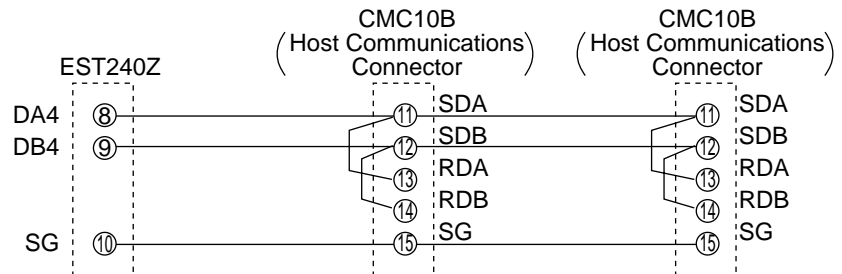

● Connecting CMC10B and DMC10

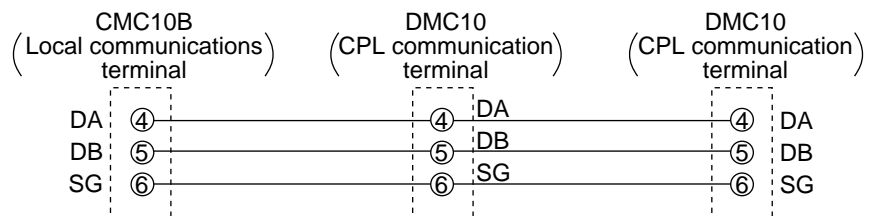

Handling Precautions

- When linking the DMC10 to a CMC10B, or two or more DMC10s ensure that the communication disconnection switch is set to the "CONNECT ←" side. (Factory default)
For details, refer to the following manuals.
Communication Controller CMC10B (CPL/CPL Converter)
User's Manual (Design Manual) Manual No.CP-SP-1064E
Module Controller DMC10 Description of Function Manual
(Manual No. CP-UM-5143E)
- Connect terminator (120 to 150 Ω , 1/2W) to both ends of the EST240Z and the CMC10B.
- The DMC10 has a built-in resistance equivalent to a terminator.
Do not connect an external terminal resistor.

Chapter 4. COMMUNICATION SETUP

■ Configuration of the Communication Parameters

The communication parameters of the Package are as follows:

Baud rate : 19200 bps

Data format: bit length 8, even parity, 1 stop bit

● Configuration of EST240Z

The communication parameters are set automatically in the EST240Z when a Package is downloaded to it.

● Configuration of DMC10

The DMC10's communication parameters are set as above when shipped from the factory. To confirm, open the "Communication" item with the DMC10 PC loader. The settings should be as follows:

Baud rate : 3 (19200 bps)

Data format : 0 (8bit/ even parity/ 1 stop bit)

● Configuration of CMC10B(CMC link version only)

The CMC10B requires two types of communication configuration; "Host Communications Setup" to connect with the EST240Z and "Local Communications Setup" to connect with the DMC10.

The transmission speed of the "Host Communications Setup" is set by the rotary switch on the CMC10B's front panel.

Rotary Switch HOST ↔ CMC B.RATE : 2 (19200bps)

Other conditions are set as above when shipping from the factory. To confirm, use the CMC10B PC loader. The settings should be as follows:

- Host Communication

Data format : 0 (8bit/ even parity/ 1 stop bit)

- Local Communication

Baud rate : 2 (19200 bps)

Data format : 0 (8bit/ even parity/ 1 stop bit)

❗ Handling Precautions

The new setting of the CMC10B's rotary switch becomes effective after switching the power OFF, then ON again.

■ Configuration of the Communication Addresses

● Configuration of EST240Z

The EST240Z does not require any communication address configuration.

● Configuration of DMC10 (Direct link)

For Direct link, set the communication address rotary switch "ADR" of the 1st through to 15th (max.) DMC10 for 1 to 15 (1 to F), respectively.

! Handling Precautions

- Each DMC10 must have different communication address.
If the number of the DMC10 units connected is 14 or less, one or more communication address can be reserved for the additional installation of units in the future.
For example, the DMC10 communication address can be set as follows:
1, 2, 5...
Unused addresses in this example are available for the future use.
- The new setting of the DMC10's rotary switch becomes effective after switching the power OFF, then ON again.

● Configuration of CMC10B/DMC10 (CMC link)

For CMC link,

- (1) Set the "CMC ADDRESS" rotary switches on the front face of the 1st through to 8th(max.) CMC10B for 01 to 08, respectively. The Address is set by the two rotary switches, "x 10" and "x 1". When setting an address of less than 10, the "x 10" switch must be set for 0.
- (2) Set the communication address rotary switch "ADR" of the 1st through to 15th (max.) DMC10 that are connected to CMC10B for 1 to 15 (1 to F), respectively.

! Handling Precautions

- Each DMC10 that is connected to the same CMC10B must have a different communication address.
If the number of the DMC10 connected is 14 or less, one or more communication address can be reserved for the additional installation of units in the future.
For example, The DMC10 communication address can be set as follows: 1, 2, 5...
Unused addresses in this example are available for the future use.
- A DMC10 that is connected to a different CMC10B can use the same communication address.
- The new settings of the CMC10B's and DMC10's rotary switches become effective after switching the power OFF, then ON again.

Chapter 5. HOW TO USE THE PACKAGE

5 - 1 Install the Package to the PC

In order to install the Package, the AP Editor should have been installed in the PC. For information on the installation of the AP editor, see the following manual.

EST240Z Manual Application User's Manual (Manual No.CP-SP-1088E)

This section describes how to install the Package to the AP Editor in the PC.

- (1) Insert the Package floppy disc to the floppy drive of the PC.
Double-click [My Computer].
- (2) Right-click the floppy drive icon and select [Open] from the pull-down menu.



- (3) Files in the floppy disc are displayed. Double-click [Setup.exe].



- (4) Setup screen will be displayed.
- (5) Follow the instructions on the screen to continue the setup.

5 - 2 Download the Package to EST240Z

■ Download the Package only

! Handling Precautions

- All the EST240Z applications will be initialized by performing the downloading described in this section.
- By downloading the Package again to an EST240Z in which the Package has already been downloaded, the configuration will be initialized and any settings the user has made will be lost. The items to be initialized are all the items described in "5-3. Configuration Setup of the Package" (p. 5-11).

(1) Connect the PC and the EST240Z and turn on the power of the EST240Z.

(2) Startup the AP Editor.

Without opening any files, click [Online] in the menu-bar → [Download] → [Download Dedicated Package].

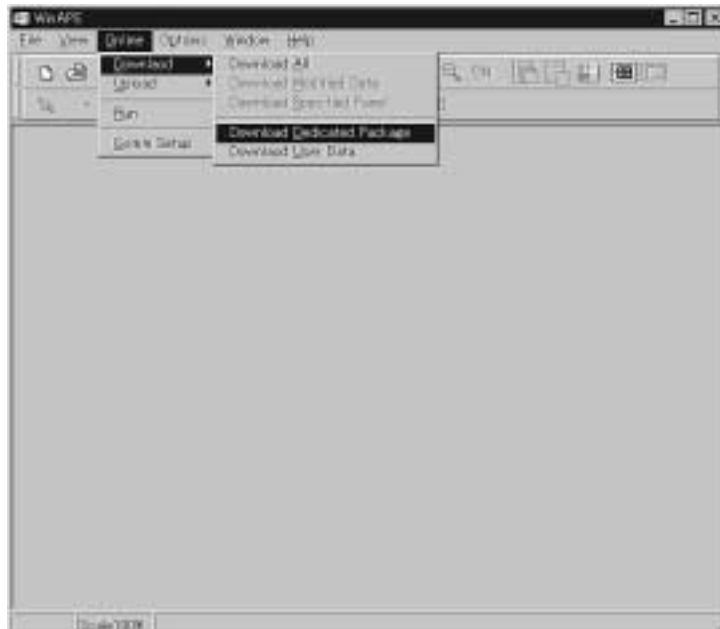

(3) Select either the Direct link or the CMC link and click [OK].

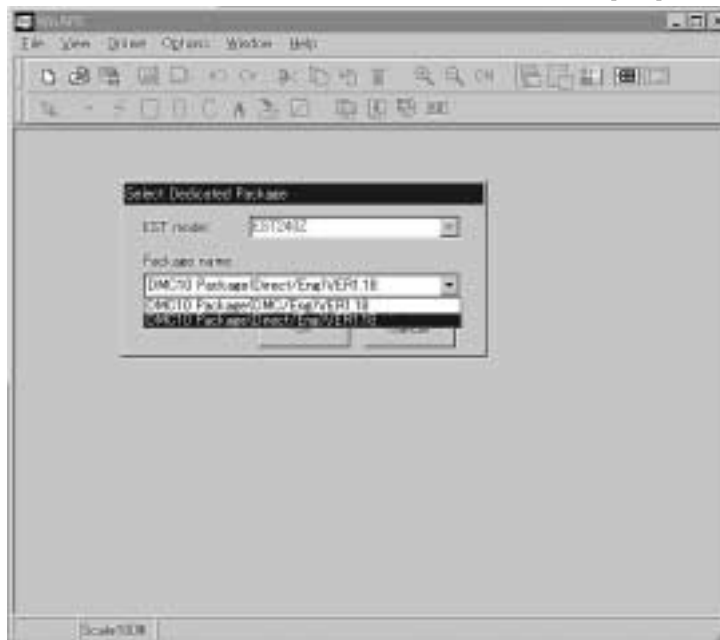

(4) Download will be performed.

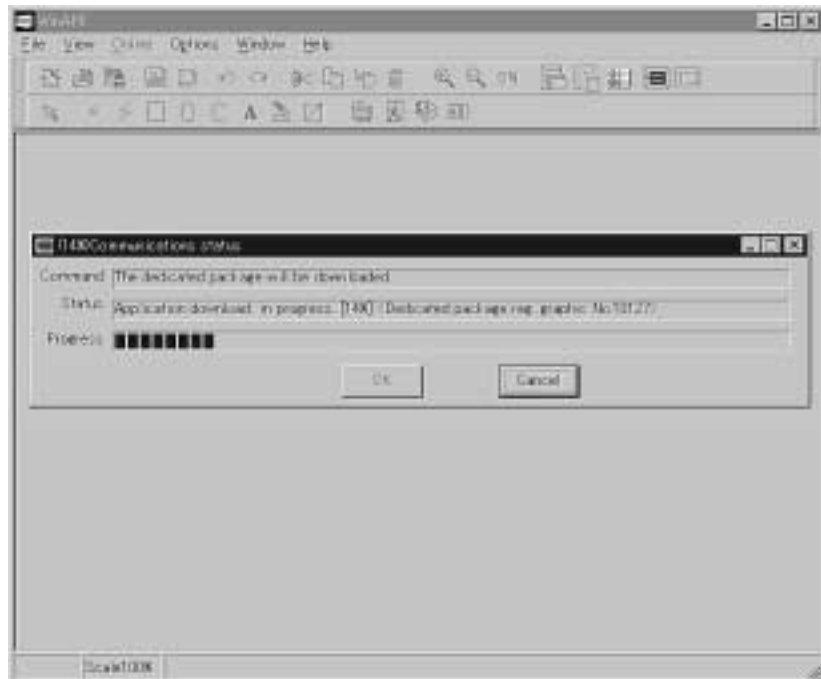

When the download has been completed, the following screen will be displayed.

If you want to start the EST, select [Yes].

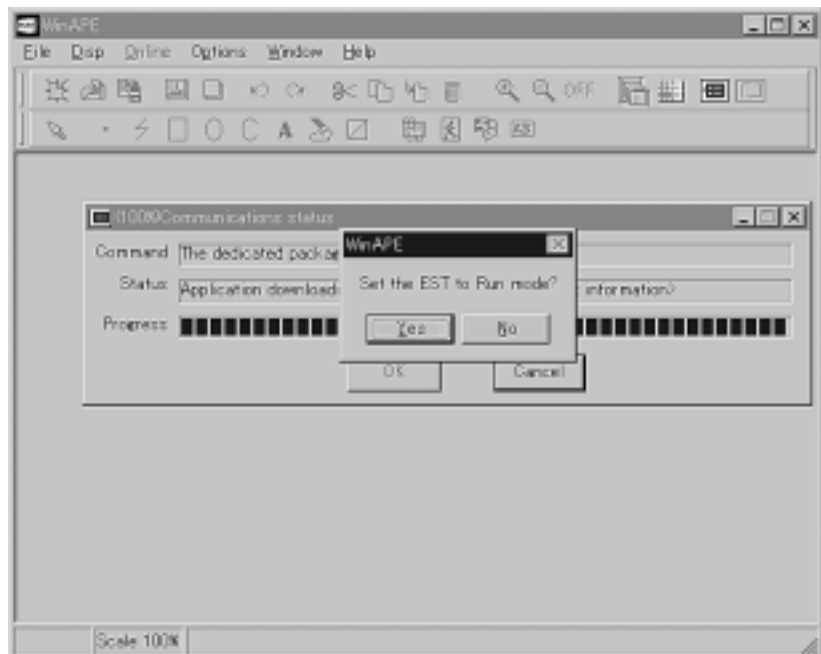

■ Download the User Application and the Package

! Handling Precautions

- If the Package has not already been downloaded to the EST240Z, the Package will be downloaded along with the User application by performing the download described in this section. If the Package has already been downloaded, only the User application will be downloaded.
- If downloading a User application which does not use a package, the Package will be deleted.

By downloading the Package again, the configuration will be initialized and any settings the user has made will be lost.

The items which will be initialized are all the items described in "5-3. Configuration Setup of the Package" (p. 5-11).

(1) Connect the PC and the EST240Z and turn on the power of the EST240Z.

(2) Startup the AP Editor and create a User application.

For information on how to create a User application, see the following manual.
EST240Z Application Manual (Manual No.CP-SP-1088E)

(3) Setup the Package.

Open [Configuration Information]-[General] from the application manager.

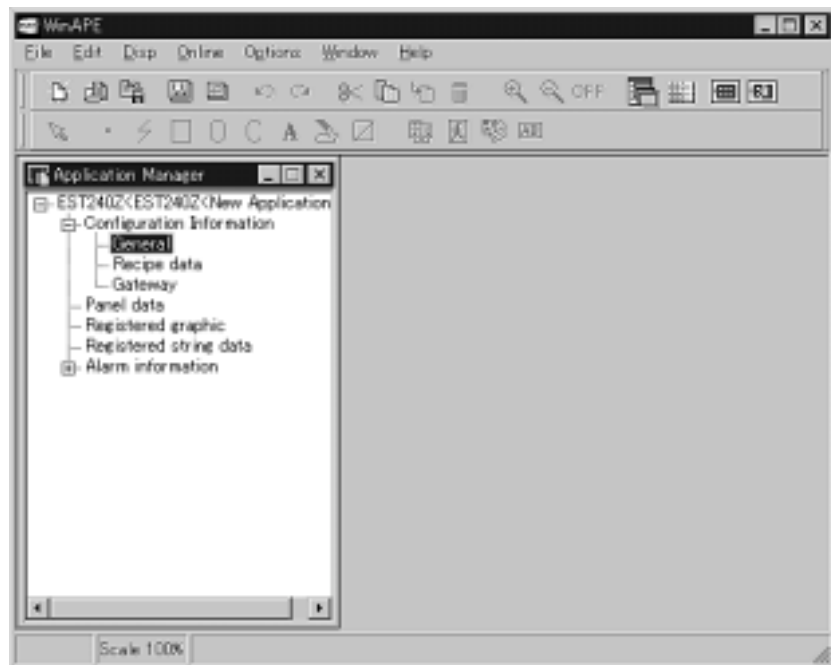

(4) Setup the options.

Click on [Package/Option] and select either the Direct link or the CMC link.
Click [OK].

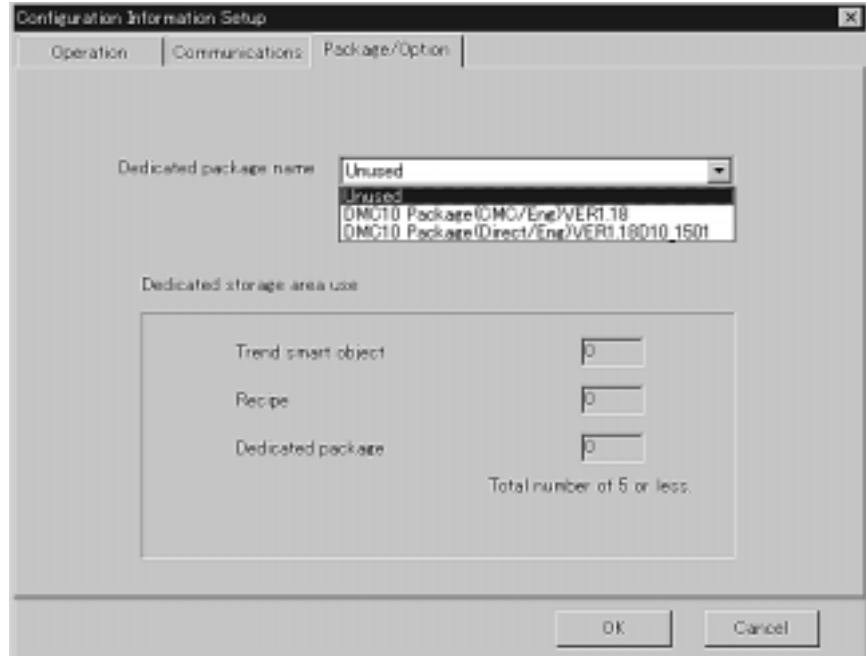

By clicking [OK], the communication settings of CH4 will be automatically changed according to the selected Package.

(5) Save the file.

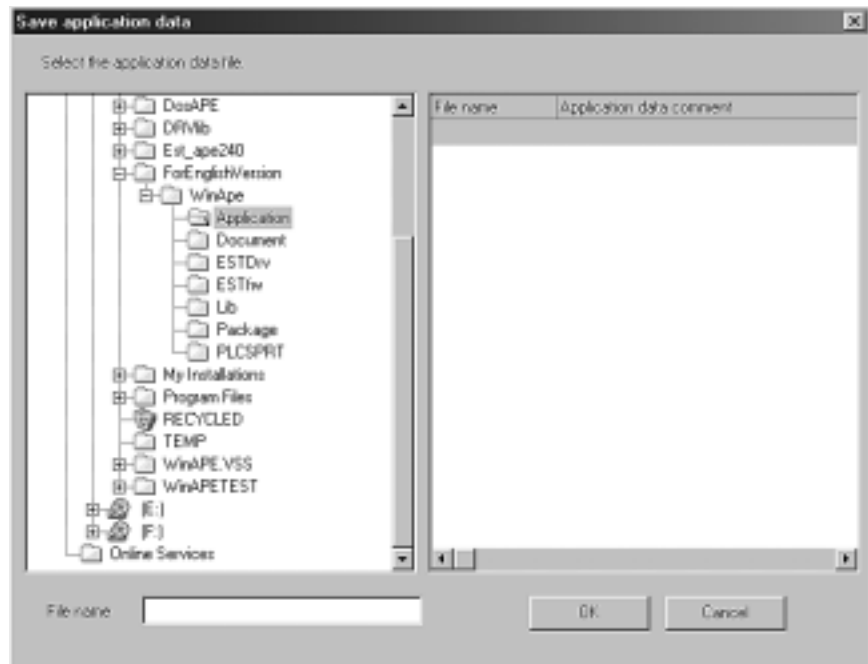

(6) Download the application.

Click [Online] in the menu-bar → [Download]→ [Download All].

Follow the messages on the screen to perform the download.

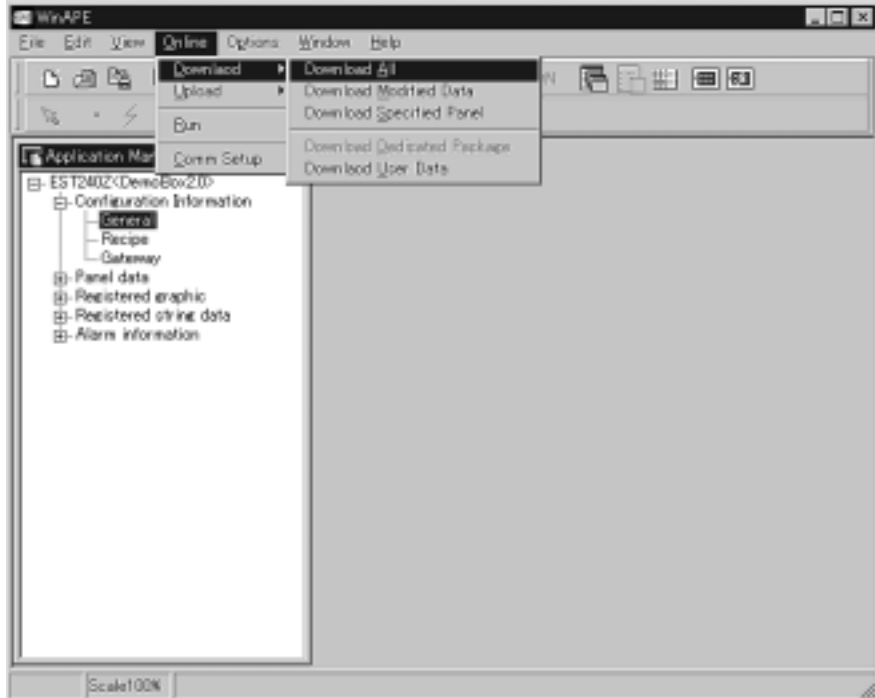

When the download has been completed, the following screen will be displayed.

If you want to start the EST, select [Yes].

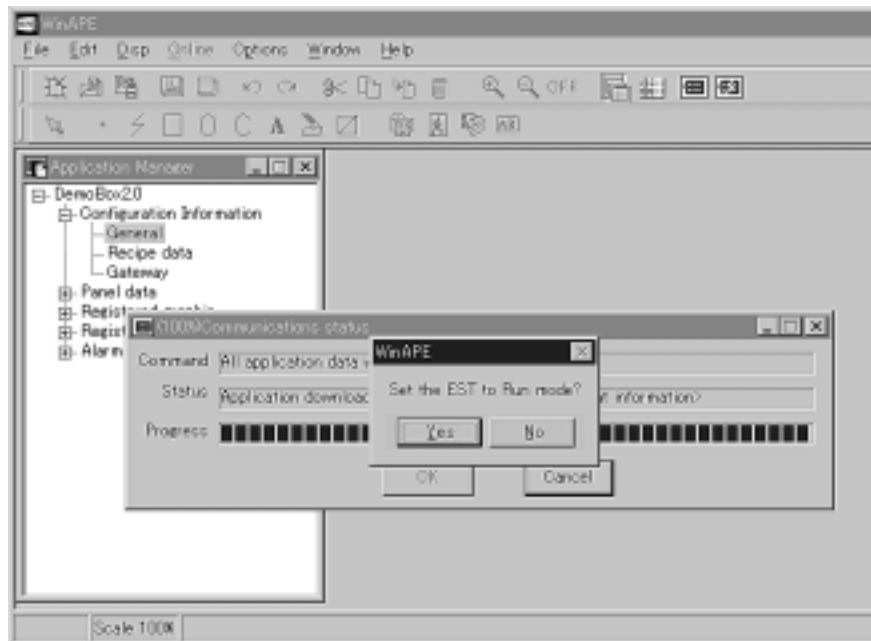

■ Download User-data of the package

This section describes how to download the User-data (the data set by the user) of the Package such as Display configuration and Name configuration.

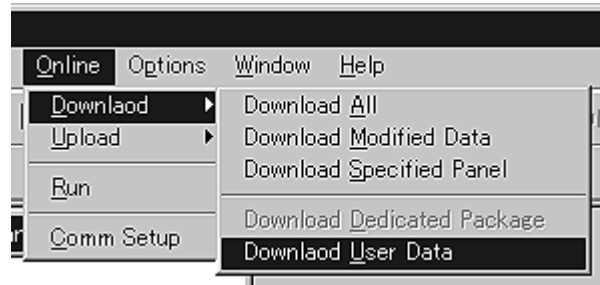

Use the User-data that has been uploaded from the EST.

(1) Click [Online] in the menu bar → [Download] → [Download User Data].

The following window will be displayed.

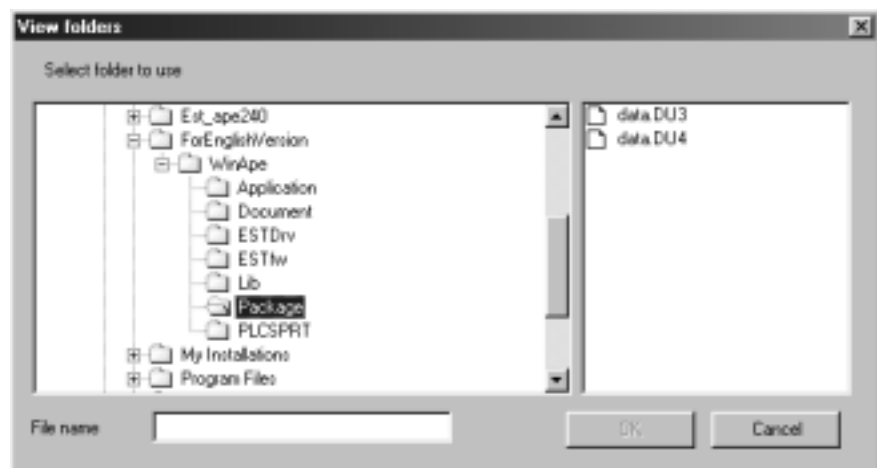

(2) User-data select dialog will be displayed after selecting the file.

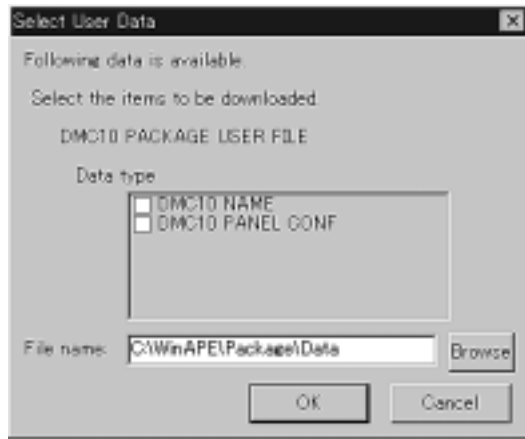

- Data type : Items that can be downloaded are displayed. Select the item to download and mark the check box.
- File name : File names to download are displayed.
- Browse : Click this button to display the file select window to change the file to download.

(3) Click [OK]. Communication status window will be displayed.
Click [OK]. Download will be executed.

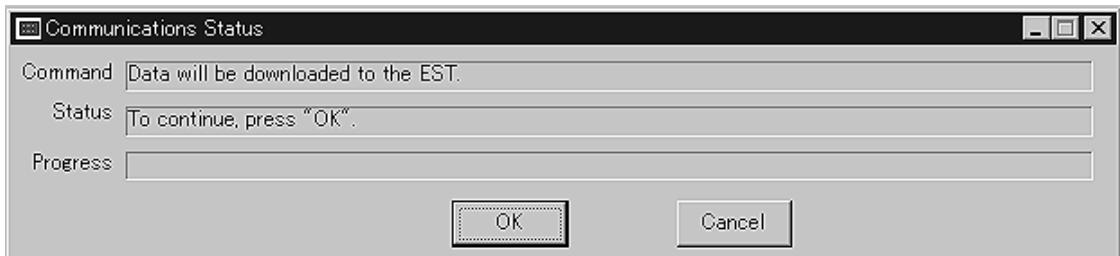

Handling Precautions

If the package has not been installed, downloading of the User-data of the Package is not possible.

■ Upload User-data of the Package

This section describes how to upload the User-data of the Package (already downloaded) in the EST such as Display configuration and Name configuration.

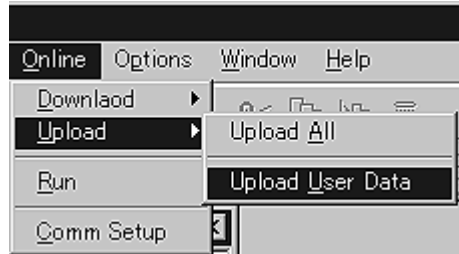

- (1) Click [Online] in the menu bar → [Upload] → [Upload User Data].
User-data select dialog will be displayed.

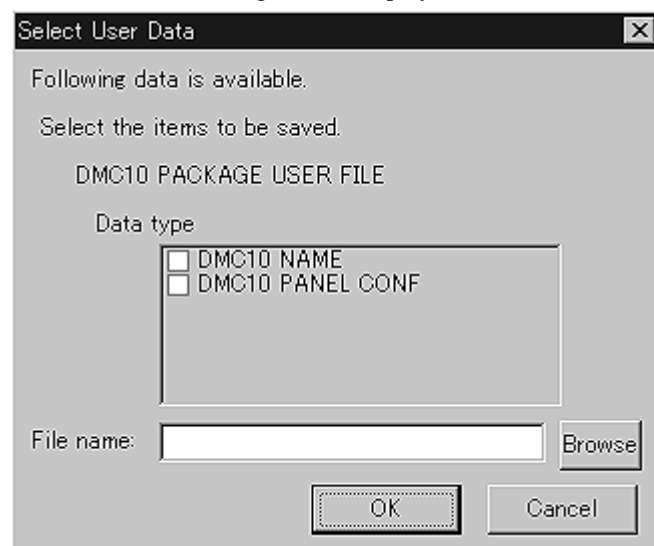

- Data type : Items that can be uploaded are displayed. Select the item to upload and mark the check box.
- File name : Input the file name for the uploaded data. The default folder is the one in which the package is installed.
- Browse : Click this button to display the file select window to change where to save the uploaded data.

(2) Click [OK]. Communication status window will be displayed.

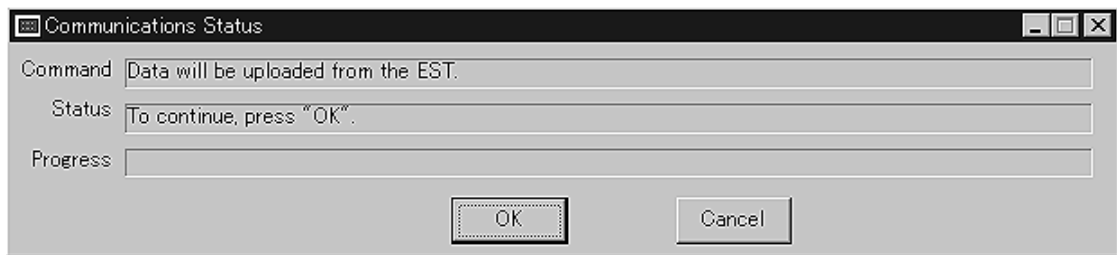

Click [OK]. Upload will be executed.

Handling Precautions

- If the package has not been installed, uploading the User-data of the Package is not possible.
- Do not edit the uploaded data other than by using the EST. Otherwise, the package may not function correctly after such edited data is downloaded.

5 - 3 Configuration Setup of the Package

After downloading the Package, the user should perform the necessary configuration in order to use the Package.

- **Auto Device Assignment**

The device configuration of the CMC10B and the DMC10 that are connected to the EST240Z are registered to the EST240Z by the Auto Device Assignment. This must be performed when starting up the system or when the basic parameters of the DMC10 have been changed by PC loader.

- **Name Configuration**

Unit names can be given to the CMC10B, and module names and channel names can be given to the DMC10.

Name Configuration data can be uploaded/downloaded as User-data.

- **Display Configuration**

The user can choose the necessary display functions.

Display Configuration data can be uploaded/downloaded as User-data.

- **CMC Buffer Configuration (CMC link version only)**

Configuration of the function which performs cyclic buffering of DMC10 data in the CMC10B.

- **Alarm Definition**

The DMC10 events specified by the user can be added to the DMC10 Alarm monitoring.



Note

Although the "Auto Device Assignment" must be performed when starting up the system for the first time, other items can be set or changed afterwards.

■ Start Up the Package

When starting up the Package for the first time after downloading, the following screen will be displayed.

Touch [OK] to display the main menu.

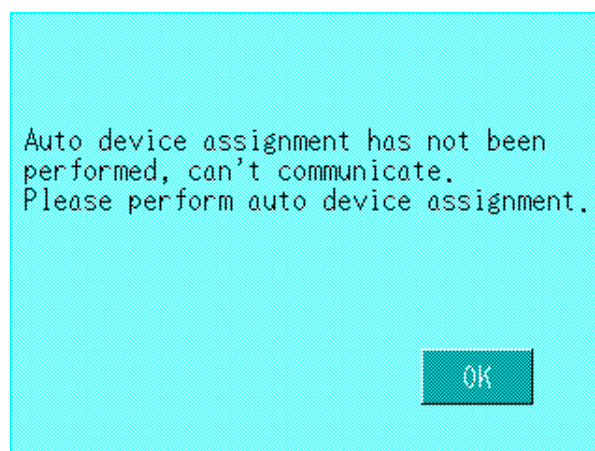

Note

After the "Auto Device Assignment" has been completed once, this screen does not appear when starting the Package. Instead, the message "Please wait..." will be displayed for about 15 seconds (10 seconds for the Direct link version) after the power is turned on and then the main menu will appear.

● Main Menu

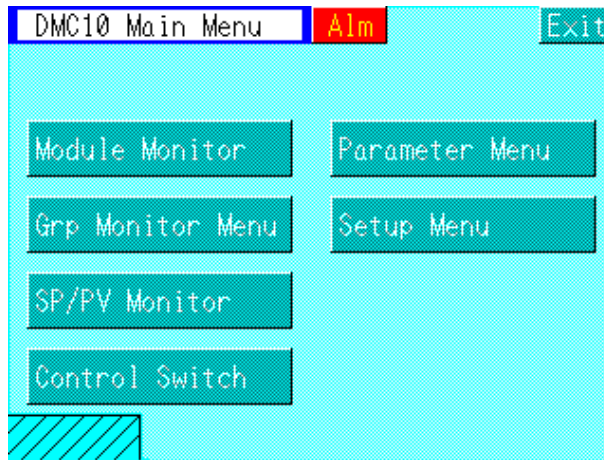

To display the Package Configuration Menu, press the lower left corner (the diagonally shaded areas in the above screen example) for at least 3 sec.

 Note

The user can select which items are displayed in the main menu. See ■ Display Configuration (p.5-17) for detailed information.

 Handling Precautions

"Exit" is not displayed when only a Package is downloaded and a User-application is not used.
See Chapter 8. COMBINED USE WITH USER APPLICATION for detailed information.

● Package Configuration Menu

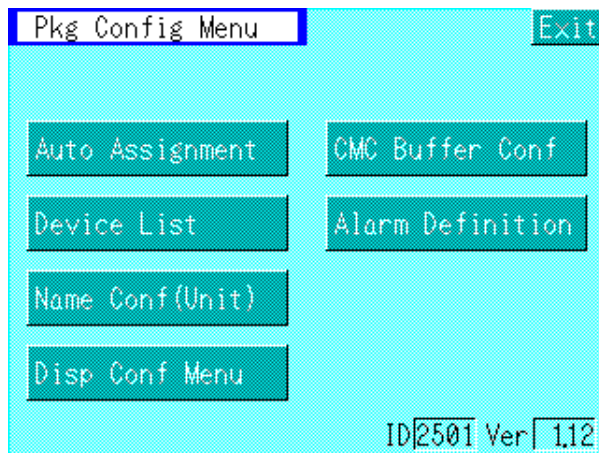

The following chart shows the configuration menu screen flow.

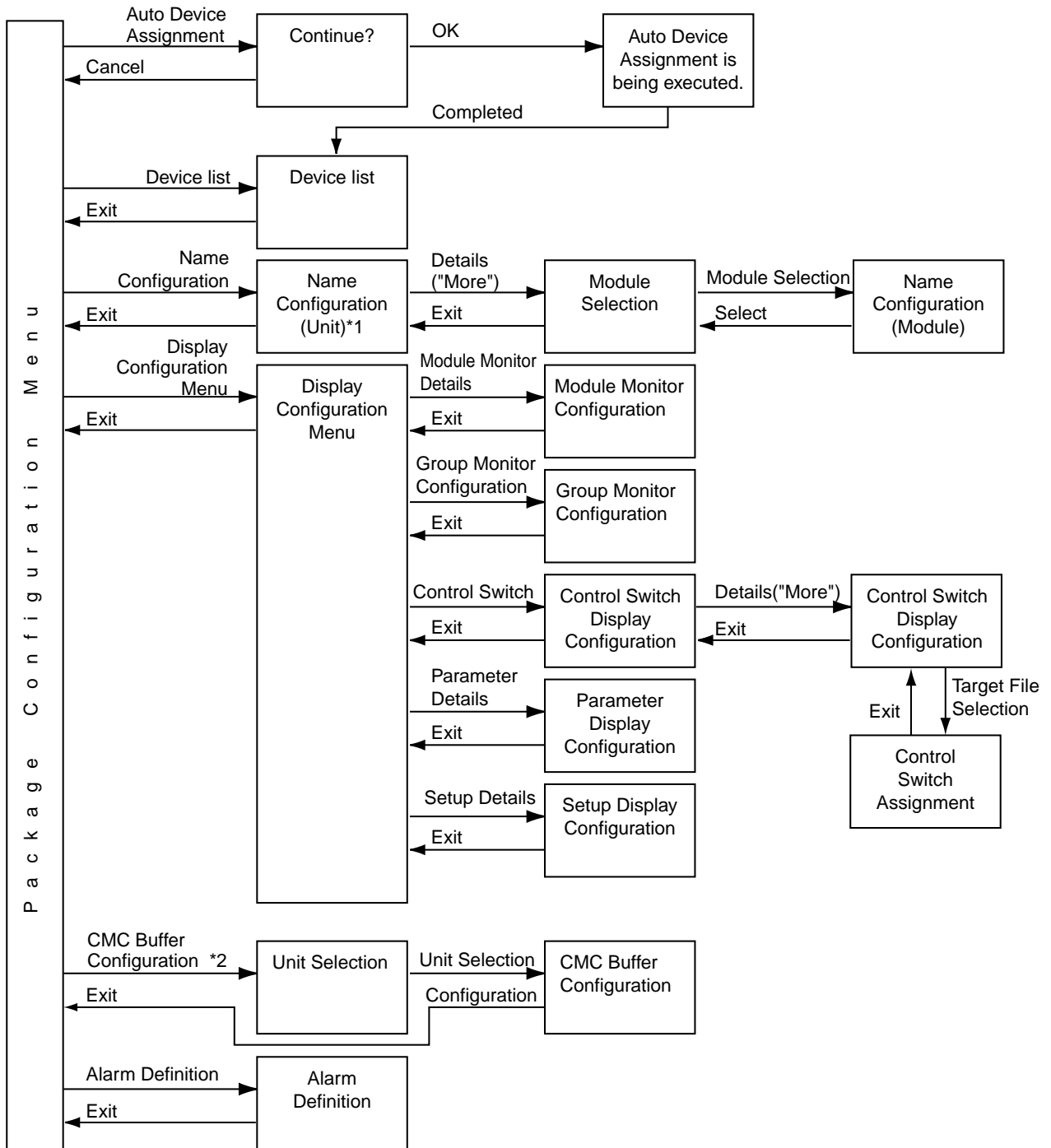

*1 "Name Configuration (Unit)" is not provided in the Direct-link version.

*2 "CMC Buffer Configuration" is not provided in the Direct-link version.

■ Auto Device Assignment

- (1) Check that all the devices that comprise the system (EST240Z, CMC10B and DMC10) are connected correctly and the communications configured.
Turn the power on.
- (2) Touch [Auto Assignment] in the Package Configuration Menu.
The following confirmation screen will be displayed.

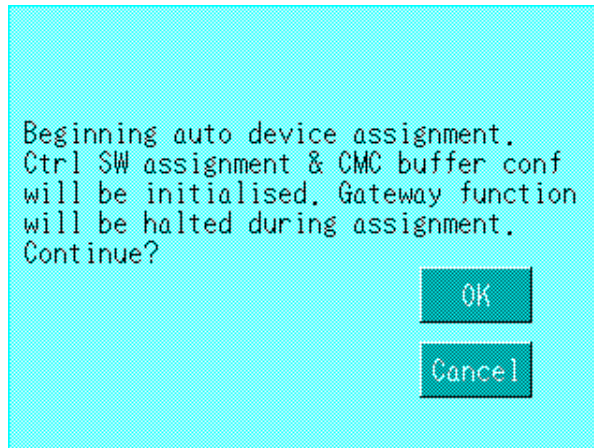

! Handling Precautions

The Control Switch Assignment and the CMC Buffer Configuration (CMC link version only) will be initialized by executing this Auto Device Assignment.

The gateway function in action halts while the Auto Device Assignment is being executed. It resumes again when the Auto Device Assignment has been completed.

- (3) Touch [OK] to execute the Auto Device Assignment.
The following screen will be displayed to indicate the progress.
When completed, it will display the "Device List" screen automatically.

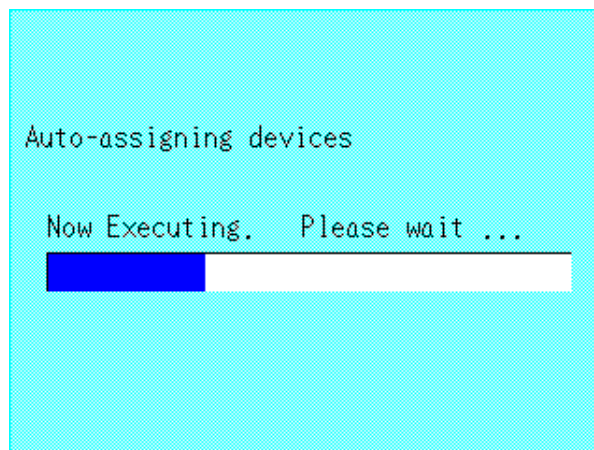

! Handling Precautions

When the system configuration is changed or when any of the following parameters are changed by the DMC10 PC loader after the Auto Device Assignment has been performed, Auto Device Assignment should be performed once again

- Input type
- Decimal point position
- PV range low limit
- PV range high limit
- SP low limit
- SP high limit

If these parameters are changed by the "Setup" of the Package, it is not necessary to perform Auto Device Assignment again.

Conversely, if when position proportional control mode is used its control type is changed from 1 or 2, to 0, 3, or 4, then it is necessary to perform Auto Device Assignment again.

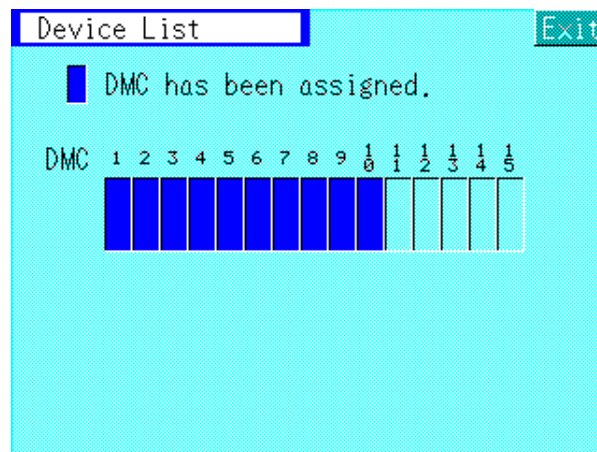

● Device list (Direct link version)

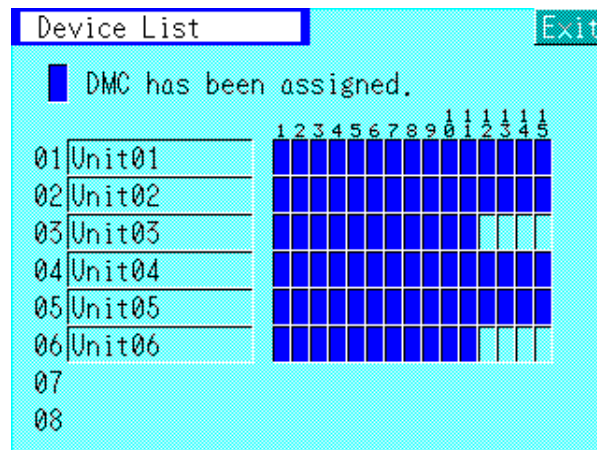

● Device list (CMC link version)

In this screen, the assigned DMC10 units are indicated by blue lamps. Check that all the connected devices have been assigned.

If not, check if the wiring and the communication settings are correct and execute

■ Name Configuration

The user can give names to the CMC10B units, DMC10 modules and channels. In the initial settings after downloading the package, the default names are as follows: Unit names are Unit01 to Unit08, Module names are Module01 to Module15, and Channel names are ch1 to ch4.

If the user does not need to give other names, this configuration is not necessary. Touch [Name Conf] in the Package Configuration Menu. The following screen will be displayed.

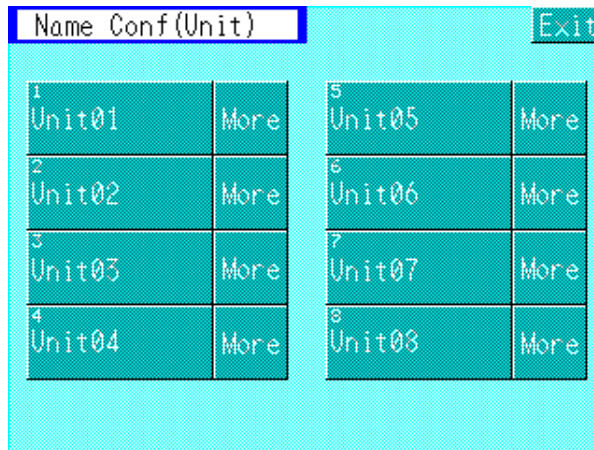

● Unit Name Configuration

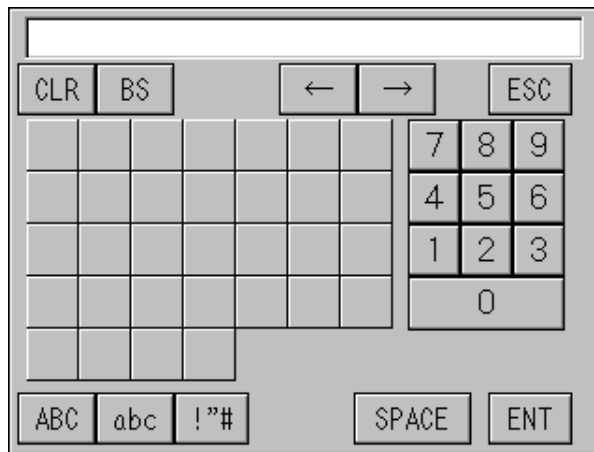

- Touch a unit name. Keyboard pops up.
- Touch [More] to display the Module Selection screen of each unit. Select the target module.

● Screen Keyboard

Input the desired unit name. (up to 12 letters.)

● Module Name Configuration

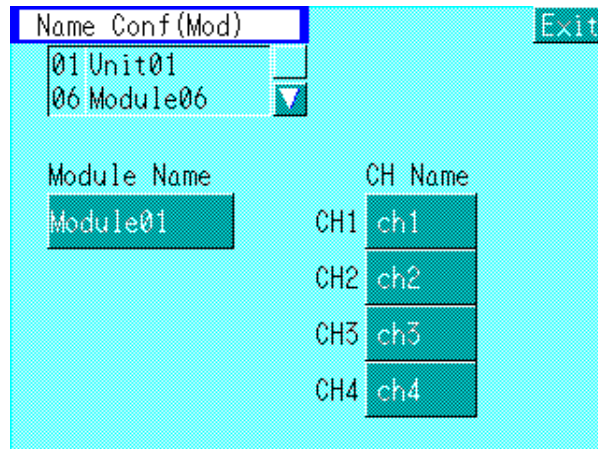

- Module name can be up to 12 letters.
- Channel name can be up to 6 letters.

! Handling Precautions

In the Direct link version, "Unit Name Configuration" screen is not provided.

If the [Name Conf] in the Package Conf. Menu is touched, it will go directly to [Name Conf (Mod)].

■ Display Configuration

The user can alter the display configuration for improved usability.

Touch [Disp Conf Menu] in the Package Configuration Menu.

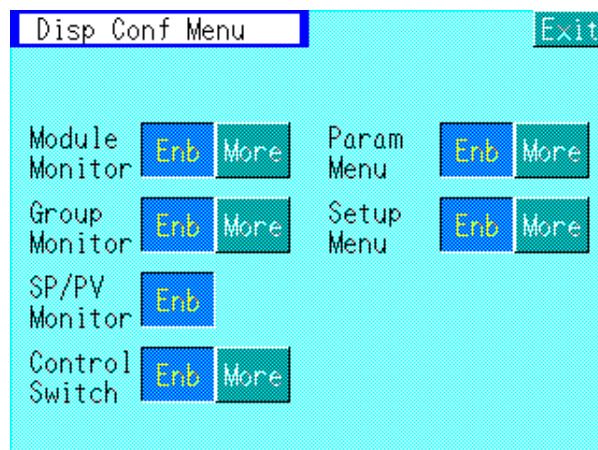

● Display Configuration Menu

- If [Dis] of the [Enb/Dis] switch is selected, that item will not be displayed in the "Main Menu".
- Touch [More] to go to the screens to set the details of each item.

● **Module Monitor Configuration**

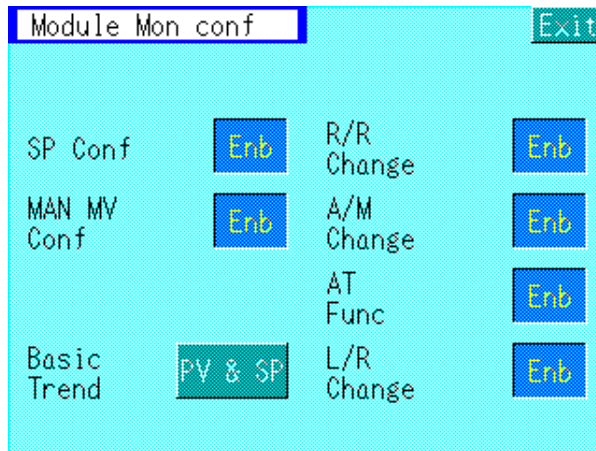

- If [Dis] of the [Enb/Dis] switch is selected, that function will be disabled in the Module Monitor.
- In the Basic Trend function, either "PV & SP" or "PV & MV" can be selected.

● **Group Monitor Configuration**

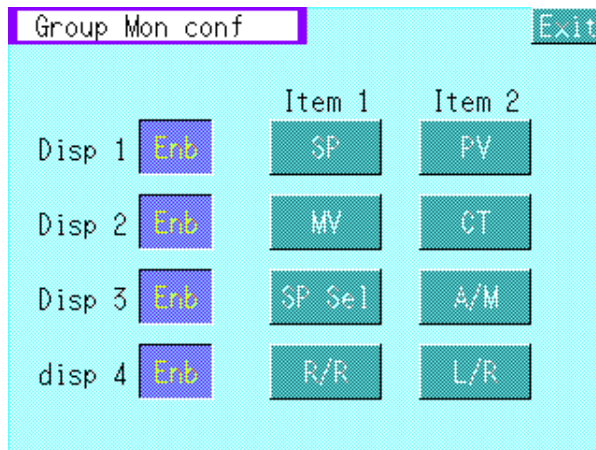

- In the Group Monitor, four (4) groups can be defined as "Disp1" to "Disp4". In each group, the user can select two (2) types of data to monitor.
- If [Dis] of the [Enb/Dis] switch is selected, that item will not be displayed in the Group Monitor Menu.
- Touch an item to display the "Selection Menu" and select the data to monitor.

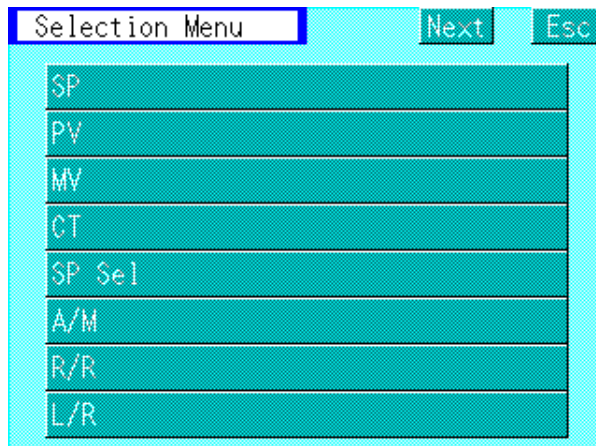

- Control Switch Display Configuration

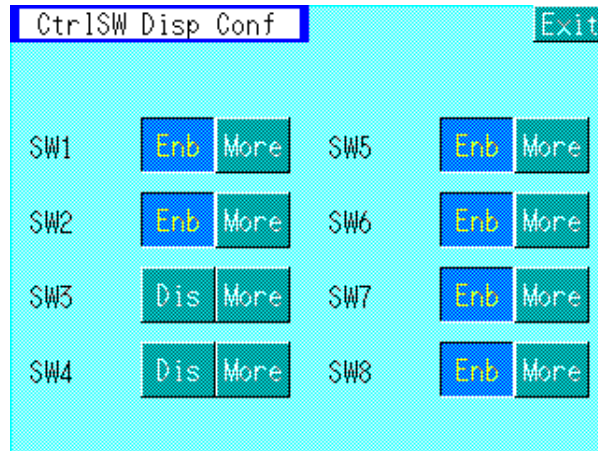

- If [Dis] of the [Enb/Dis] switch is selected, that switch will not be displayed in the Control Switch screen.
- Touch [More] to go to the screens to define each switch.

- Control Switch Definition (CMC link version)

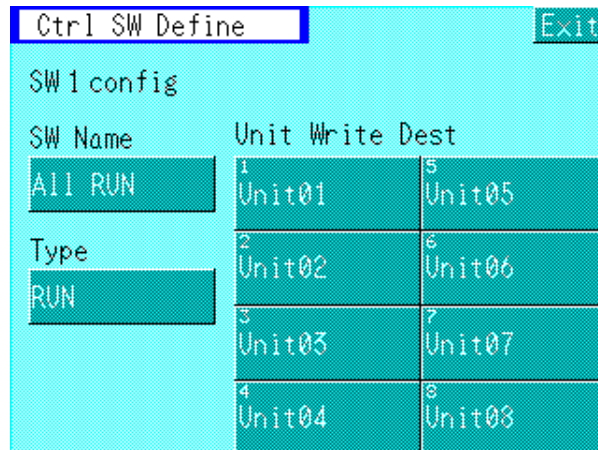

● **Control Switch Definition (Direct link version)**

The user can change the SP Group or the Mode by one operation by assigning such functions to the Control Switch.

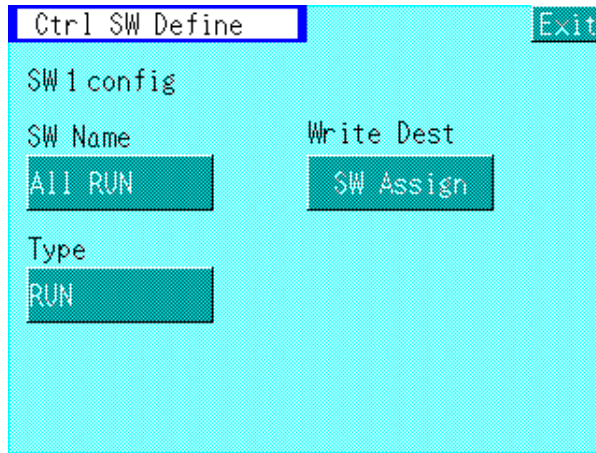

- Touch [SW Name] to popup the keyboard. Input the desired name for the switch. (Up to 12 letters.)
- Touch [Type] to display the selection menu. Select the function to be executed. The selectable functions are: SP No.1 to 8, RUN, READY, AUTO, MANUAL, AT stop, AT start.

! Handling Precautions

In order to select SP No., "Multi SP" of the "Special Functions" of the target module should be "Enb".

With the 4CH model of the DMC10, if 5 or a larger number is selected as the SP No., a communications error will occur when the Control Switch is executed.

- "Ctrl SW Assign" screen appears by touching "Unit Write Dest" (CMC link version) or "Write Dest" (Direct link version).
In this screen, select the channels for the write-destination of the Control Switch. In the CMC link version, this assignment should be made separately unit by unit to all the necessary units.

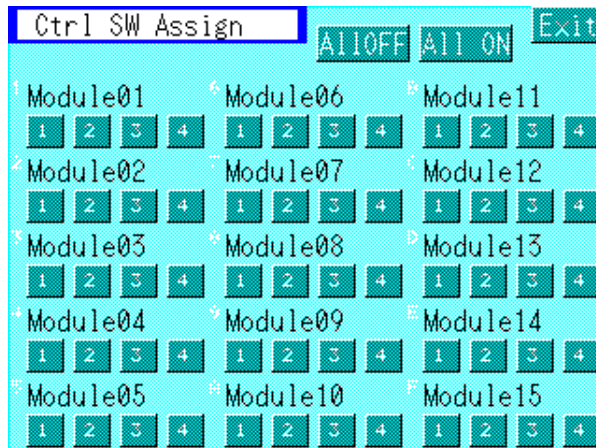

- 1, 2, 3, 4 in each module indicates the channel No.
- [All OFF] and [All ON] switches change all the channels at once.

! Handling Precautions

If the DMC10 channels have operation conditions defined with the remote switch input(RSW) or event bus output(BUS), such channels cannot be changed by the Control switch.

For example, if the user attempts to assign "RUN/READY" of the control switch to a channel that has the condition "RUN when the remote switch input is on", a communication error will occur.

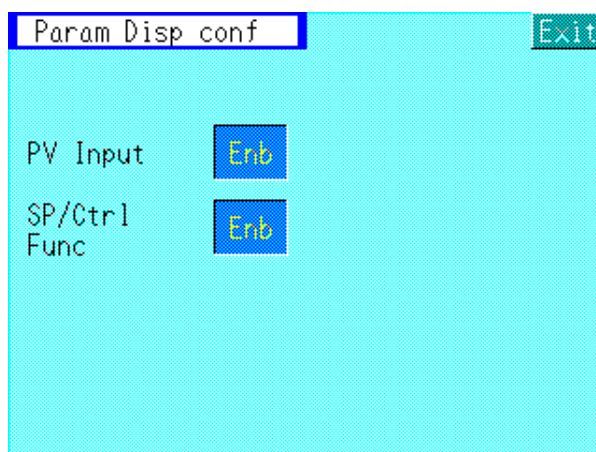

● Parameter Display Configuration

If [Dis] of the [Enb/Dis] switch is selected, that switch will not be displayed in the Parameter Menu screen.

● **Setup Display Configuration**

If [Dis] of the [Enb/Dis] switch is selected, that switch will not be displayed in the Setup Menu screen.

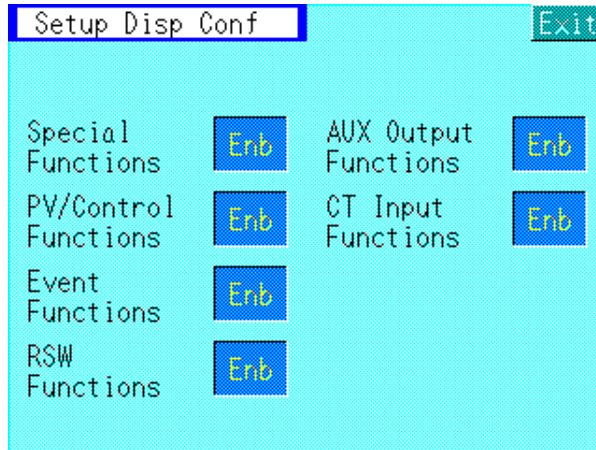

■ **CMC Buffer Configuration (CMC link version only)**

The Gateway function of the EST240Z can be used efficiently with this function. If the user does not use the Gateway function, select "Dis" in all the items. (The initial settings are all "Dis".)

See "Chapter 7. USAGE EXAMPLES - GATEWAY AND CONTROL SWITCH" for more detailed information.

When "CMC Buffer Conf" in the Configuration menu is touched, "Unit Selection" screen appears. Select the unit(CMC10B) to configure.

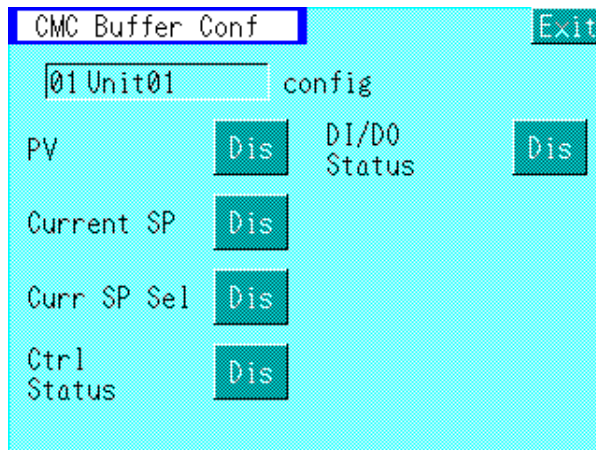

- If [Dis] of the [Enb/Dis] switch is selected, that data will not be buffered.
- Configure all the necessary units(CMC10B).

■ Alarm Definition

When using a User application and Package together, the user can select whether the DMC10 Alarm Monitor functions during the operation of the User application with "Enb" or "Dis".

If only the Package is used, this selection is meaningless.

The user can also add user-set events to the DMC10 Alarm Monitor.

In the 4 event relay outputs type DMC10 a total of 8 events can be defined including the 4 event bus outputs.

Even in a DMC10 without events, 8 events can be defined if "On" is selected in the "Event Special" section.

In this configuration, the user defines if each event is added as an alarm or not.

As the definition made in this Alarm Definition acts as the logical OR to the events of all the connected DMC10 units, this is used, for example, when the user wants to use one event channel as the high limit alarm through all the connected DMC10 units.

Name		Name	
EV1 TBL1	Dis	BUS1 TBL5	Hi Limit Enb
EV2 TBL2	Dis	BUS2 TBL6	Lo Limit Enb
EV3 TBL3	Dis	BUS3 TBL7	Dis
EV4 TBL4	Dis	BUS4 TBL8	Dis

- If [Dis] of the [Enb/Dis] switch is selected, that event will not be added to the Alarm Monitor.
- Touch a name to popup the keyboard. The user can input the event name. Such event names are displayed in the "Alarm Mod Detail" screen.
- For detailed information of the DMC10 events, see the following manual.
Module Controller DMC10 Description Functions Manual (Manual No. CP-UM-5143)

! Handling Precautions

The alarm definition of the Package acts separately from the alarm monitor of the User application that was created by the AP editor.

Chapter 6. DMC10 SETUP AND MONITORING

■ DMC10 Setup

This section describes how to display and configure the necessary data before operating the DMC10.

The data is displayed and configured on a per module basis.

The following chart shows the screen flow.

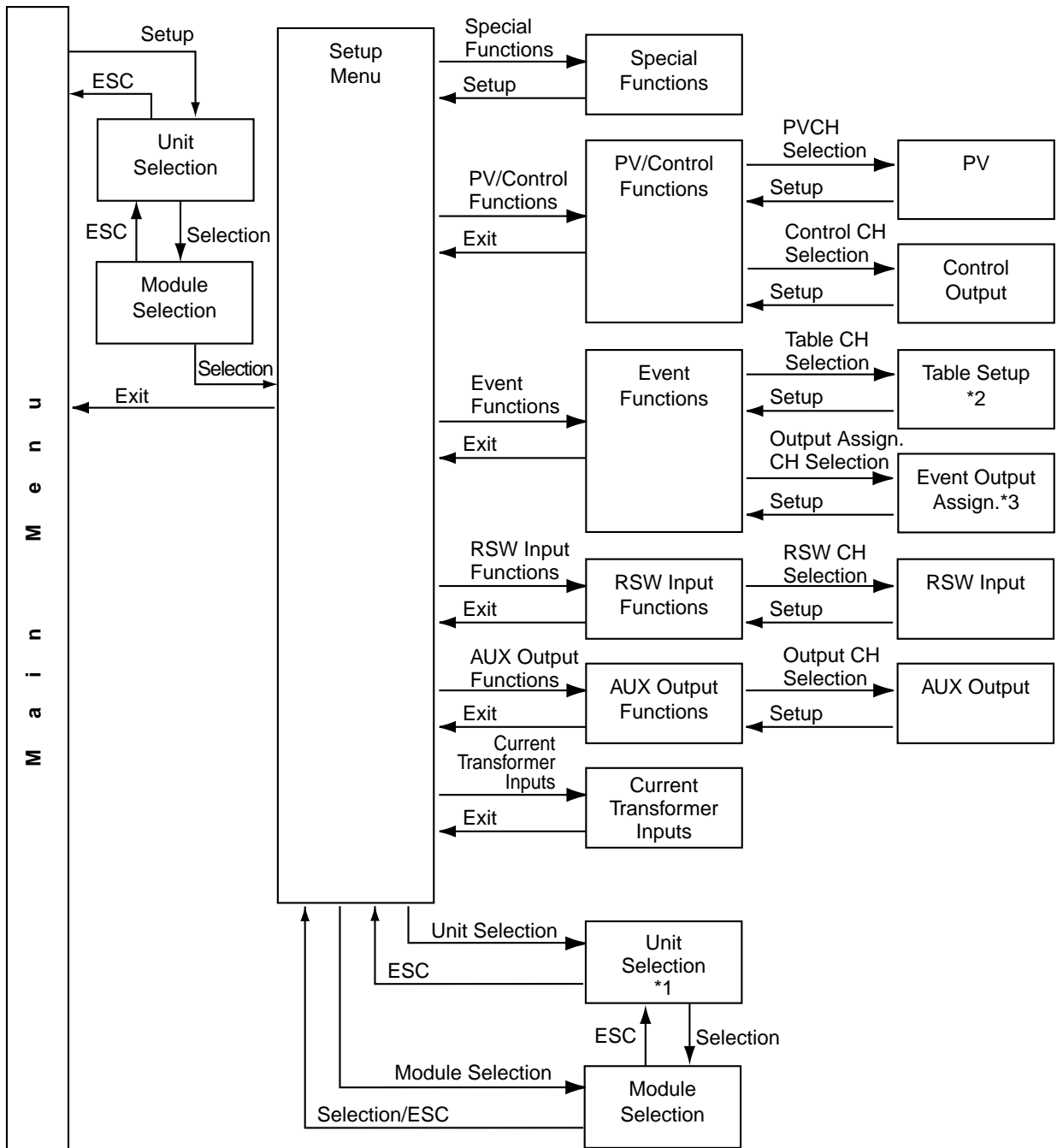

*1 : "Unit Selection" is not provided in the Direct-link version.

*2 : If the Event Special is not used, this name is displayed as "Event Output".

*3 : If the Event Special is not used, "Event Out Assign" is not available.

● Unit Selection

Touch [Setup Menu] in the Main Menu.
 Select the target unit by [Unit Selection] (CMC link version only).
 Select the target module by [Module Selection].
 The "Setup Menu" of the target module is displayed.

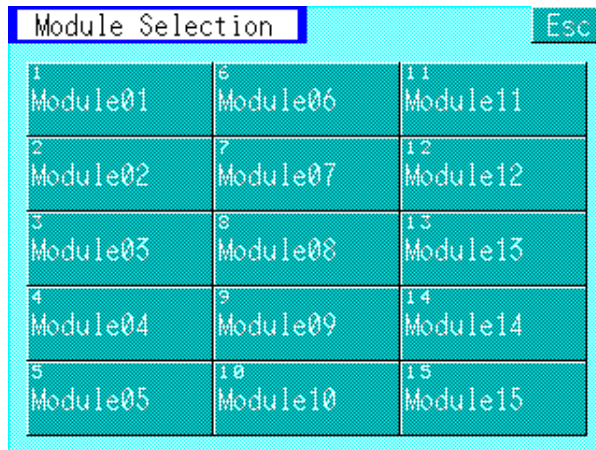
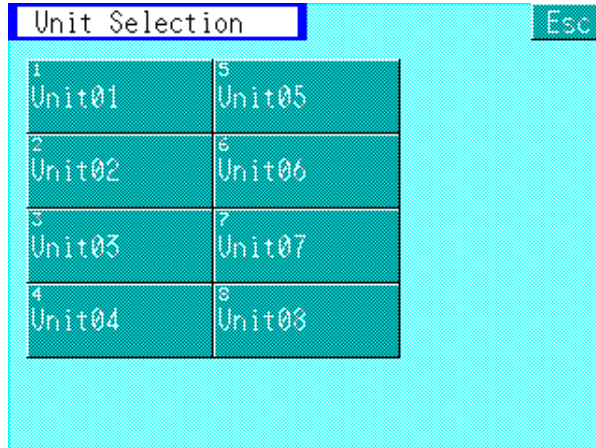

● Setup Menu

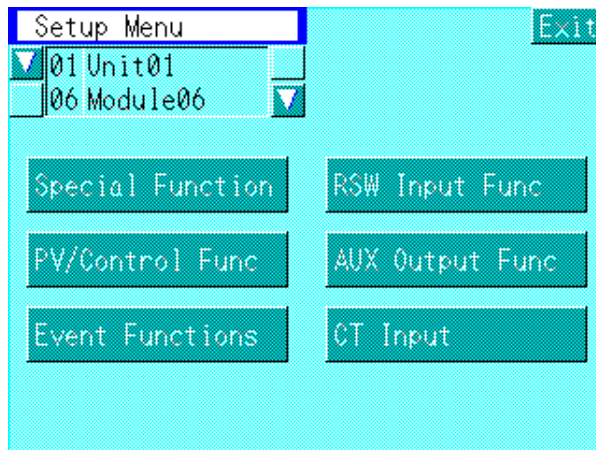

- To select the unit and module again, touch ▼ on the left of the Unit Name.
- To select the module again, touch ▼ on the right of the Module Name.

● Special Functions

The Special Functions of the DMC10 are configured with this screen.

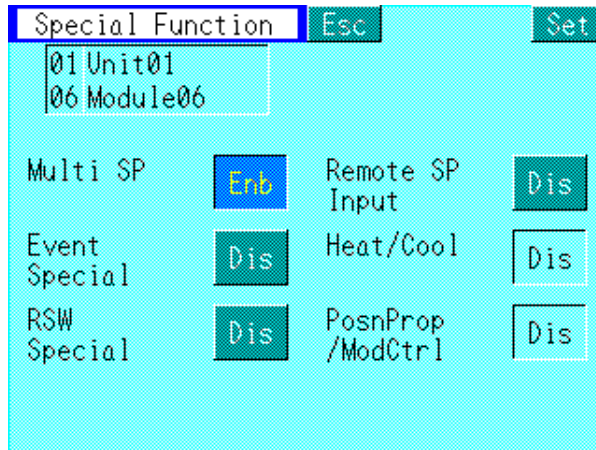

- If [Enb] of the [Enb/Dis] switch is selected, that function becomes inactive.
- "Remote SP Input" is displayed and configurable only in DMC10D (High function model).
- "Heat/Cool" is displayed only in DMC10D (High function model.)
- "Posn Prop/ModCtrl" will only be displayed for models which have this function.

! Handling Precautions

- "Enb/Dis" of "Heat/Cool", and the "Heat/Cool Output Assignment" can not be configured by the Package. They must be configured with the PC loader.
- "Enb/Dis" of "PosnProp/ModCtrl" can not be configured by the Package. It must be configured with the PC loader.
- The "Enb/Dis" of the "Remote SP Input" is selectable only when the "Heat/Cool" is "Dis" and when the type of position proportional control is set as 0, 3, or 4.

● PV/Control Function

The DMC10 Input channels are displayed.

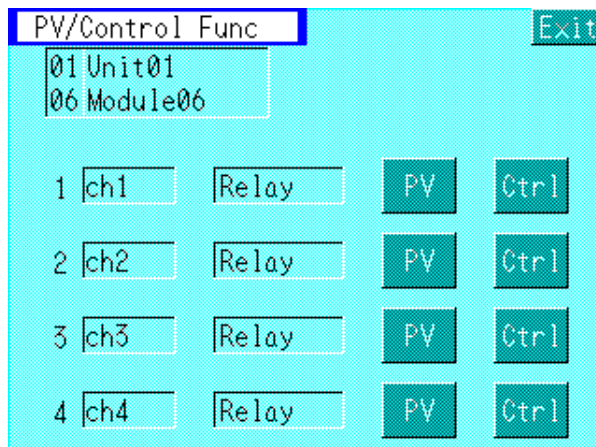

- Touch [PV] to display the PV of each channel.
- Touch [Ctrl] to display the "Control Output" of each channel.

● PV

The data related to the PV of each channel is displayed and configured with this screen.

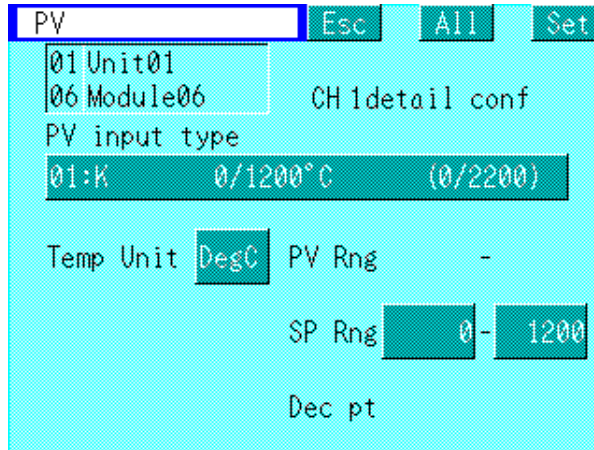

- The values in () on the right of the Input range is the range when the "Temp Unit" is set to "Special".
- [Set] :To confirm the settings and return to the previous screen.
- [All] :To set all the CH with the same data and return to the previous screen.

! Handling Precautions

If the SP range is changed after the SP has been set by the SP/Control Parameter (p.6-11), a Range Check will not be performed. Check the range by yourself and set the SP again if necessary.

● Control Output

The data for the Control Output of each channel is displayed and configured with this screen.

(1) When Heat/Cool control is not available

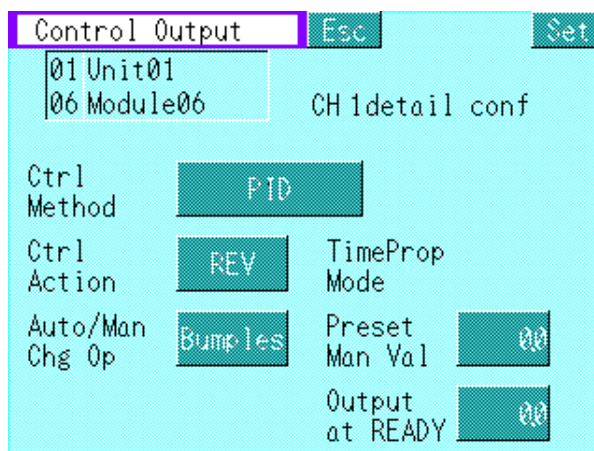

(2) When Heat/Cool control is available

Control Output		Esc	Set
01 Unit01		CH1detail conf	
06 Module06			
Cntl Method	PID		
Ctrl Action	TimeProp Mode	Heat 10	Cool 10
Auto/Man Chg Op	Bumples	Preset Man Val	00
Heat/Cool Dead zone	0.1	Output at READY	00 00

- [Set] : To confirm the settings and return to the previous screen.

(3) When Position Proportional control is available.

Control Output		Esc	Set
01 Unit01		CH1detail conf	
06 Module06			
Ctrl Method	PID		
Ctrl Action	REY	TimeProp Mode	
Auto/Man Chg Op	Bumples	Preset Man Val	00
	PosnProp/Mod	Output at READY	00

- [PosnProp/Mod] can be pressed to go to the [PosnProp/ModCtrl] screen.

● Position Proportional Control

The parameters necessary for position proportional control can be configured.

When feedback(FB) is being used, auto motor adjustment can be performed too.

PosnProp/ModCtrl		Esc	Set
01 Unit01		CH1 detail config	
06 Module06			
Dead zone	100	AutoAdjust	<input type="checkbox"/> ERR <input type="checkbox"/>
Fully Closed Input Value	1400	Start	Stop
Fully Open Input Value	6500	Open	<input type="checkbox"/> Close <input type="checkbox"/>
Open/CloseTm	65	FBPres	<input type="checkbox"/> FB Alm <input type="checkbox"/>
Motor Res.	< 400ohm	MFB	210

● **Event Functions**

Touch the item to configure.

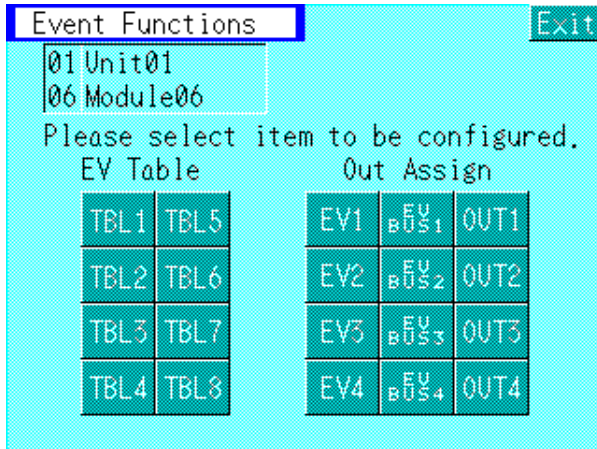

- If "Event Special" of "Special Function" is "Dis", " Out Assign" will not be displayed and the names of the EV tables will be displayed as "EV1 to 4" and "BUS1 to 4" instead of "TBL1 to 8".

● **Event Table**

The EV outputs are defined in this screen.

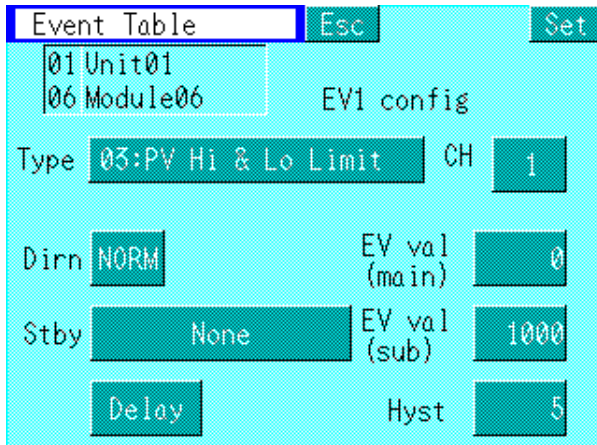

- If "Event Special" of "Special Function" is "Dis", the screen title will be displayed as "Event output".

● **Event Delay Configuration**

Event Delay is configured with this screen.

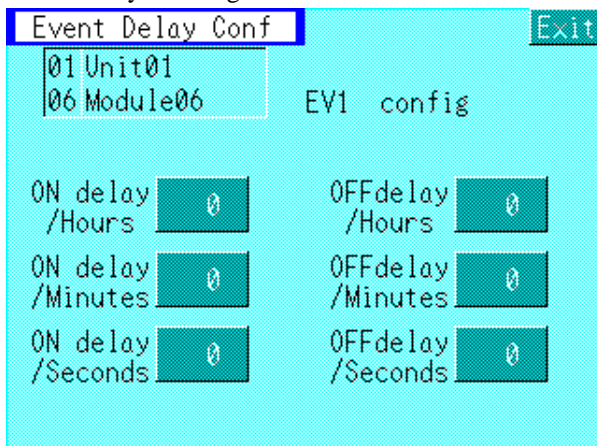

● **Event Output Assignment**

If "Event Special" of "Special Function" is "Dis", this screen will not be displayed.

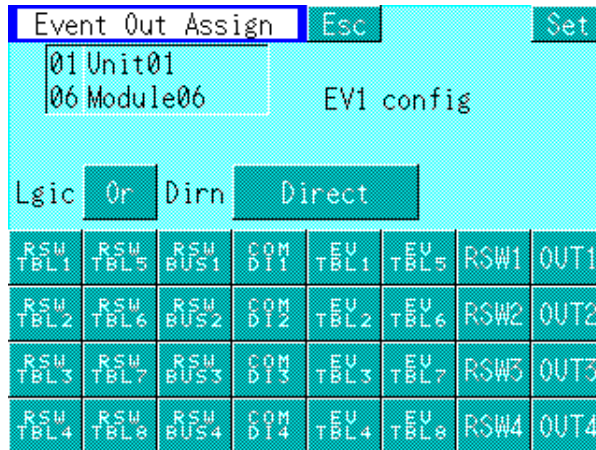

● **RSW Input Functions**

Touch the item to configure.

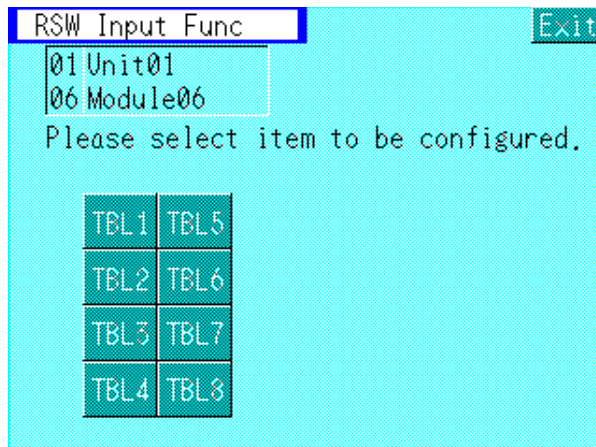

- If "RSW Special" of "Special Function" is "Dis", the item names are displayed as "RSW1 to 4" and "BUS1 to 4" instead of "TBL1 to 8".

● **RSW Input Assignment**

RSW Input is defined in this screen.

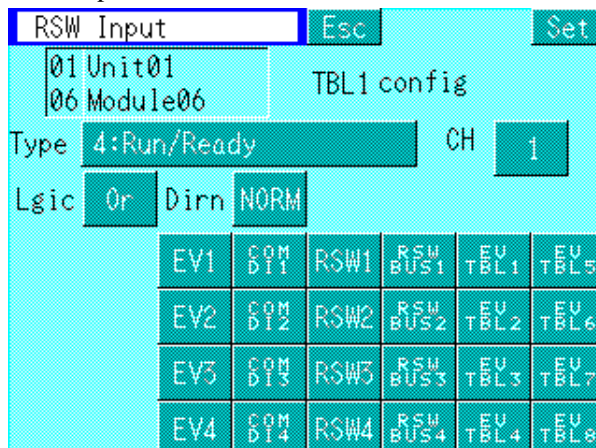

- If "RSW Special" of "Special Function" is "Dis", "Bit Assign." and "Logic" are not displayed.

● **AUX Output Functions**

Touch the item to configure.

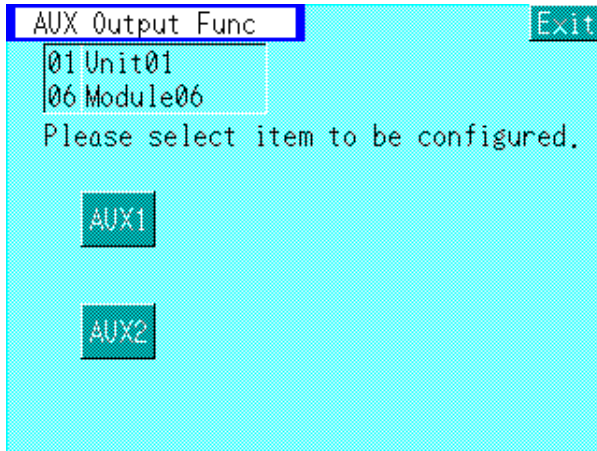

- This screen is not displayed for DMC10 units without an AUX Output.

● **AUX Output Assignment**

The AUX Output is defined in this screen.

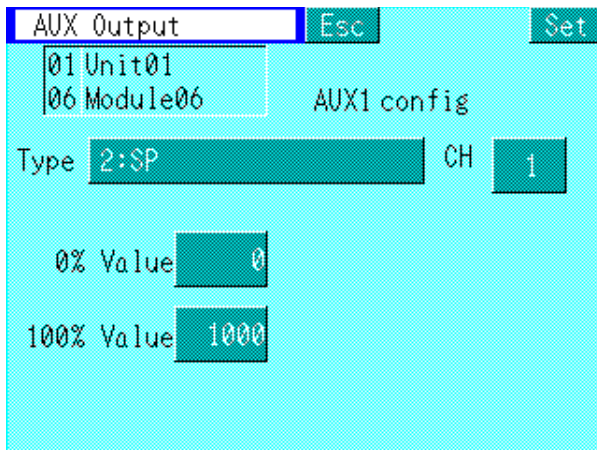

- This screen is not displayed for DMC10 units without an AUX Output.

● **Current Transformer Input**

This is to configure the Current Transformer Input.

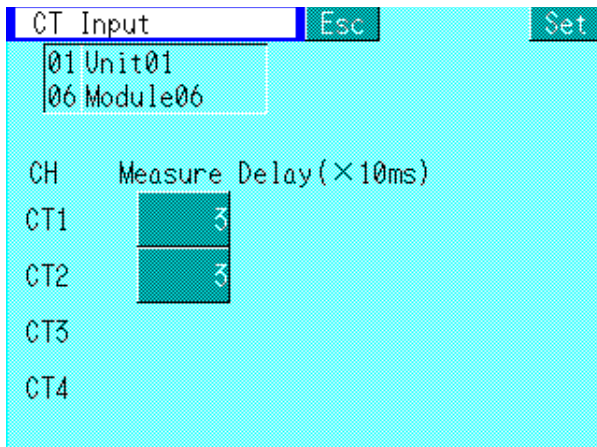

- This screen is not displayed for DMC10 units without a Current Transformer Input.

■ DMC10 Parameters

This section describes how to display and configure the necessary data to operate the DMC10.

The following chart shows the screen flow.

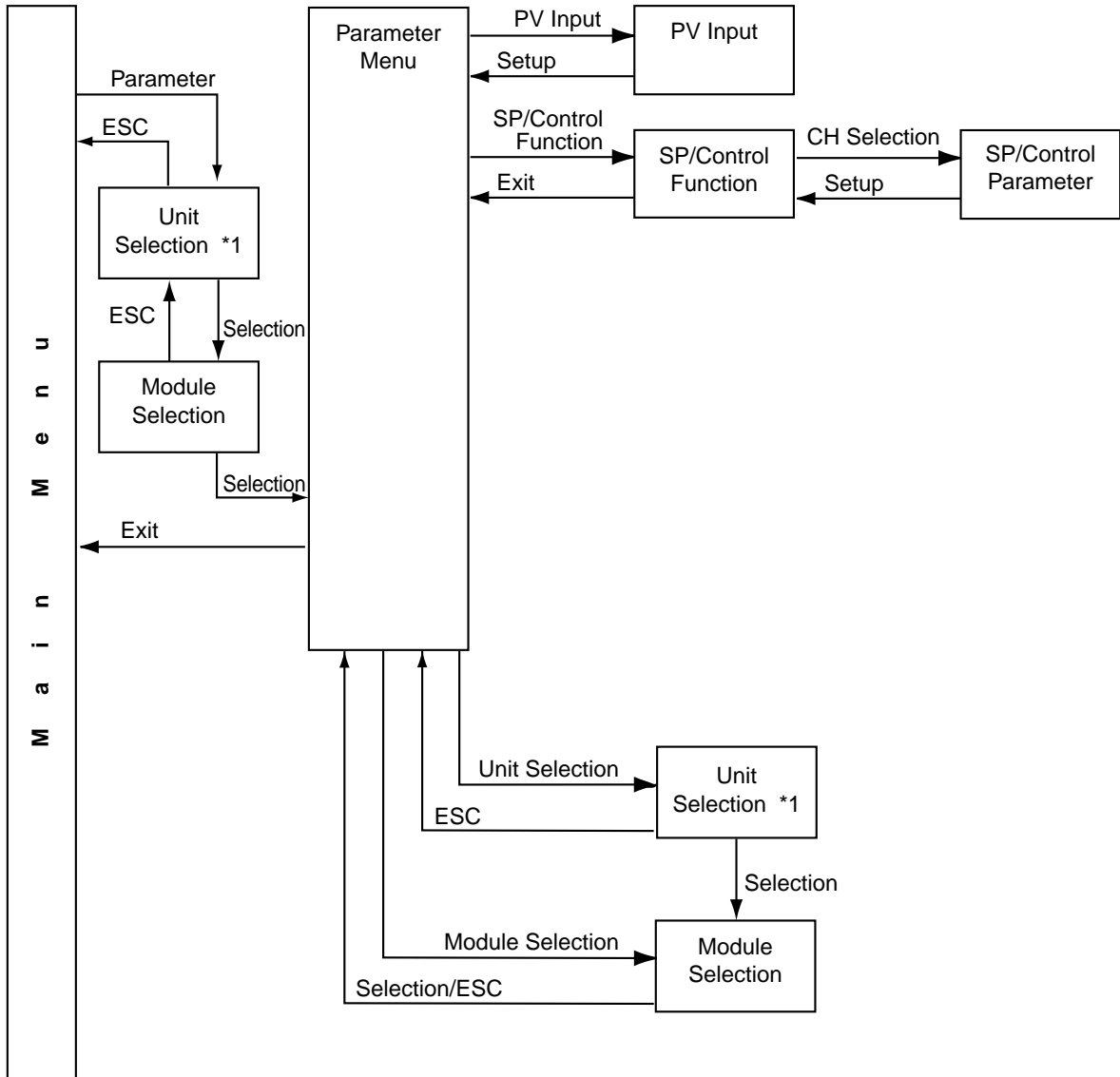

*1 : "Unit Selection" is not provided in the Direct-link version.

● **Parameter Menu**

Touch [Parameter Menu] in the Main Menu. Select the target unit by [Unit Selection] (CMC link version only). Select the target module by [Module Selection]. The "Parameter Menu" is displayed.

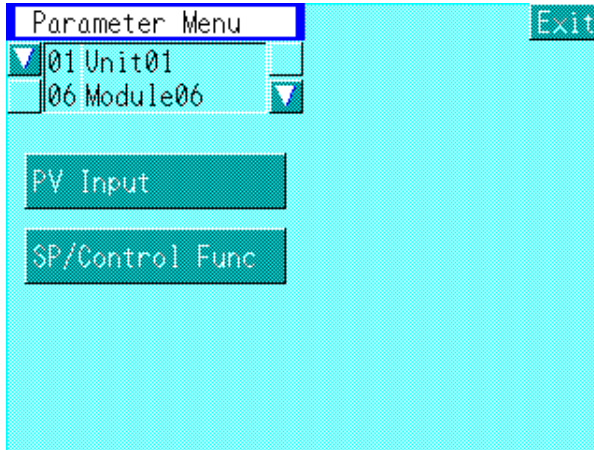

- To select the unit again, touch ▼ on the left of the Unit Name. (CMC link version only.)
- To select the module again, touch ▼ on the right of the Module Name.

● **PV Input**

PV Input Parameters are configured in this screen.

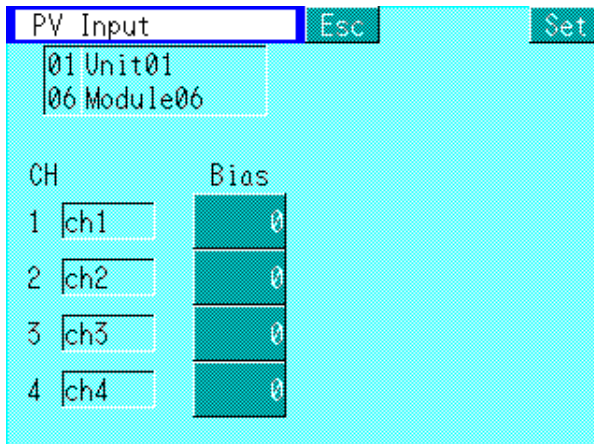

- Configure the parameters of each Input CH.

● **SP/Control Function**

Touch the CH to configure.

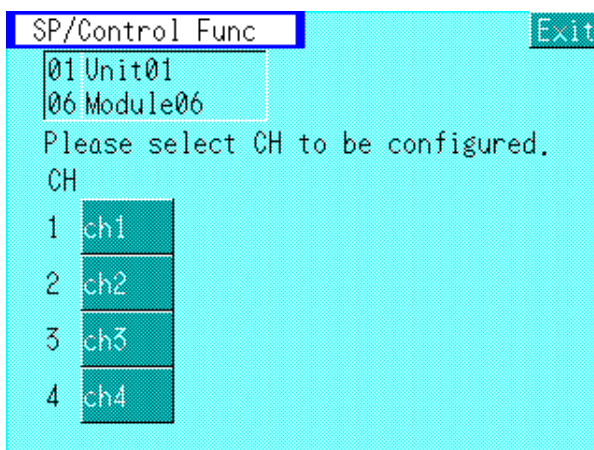

● SP/Control Parameter

Each parameter is configured in this screen.

(1) When Heat/Cool control is not available

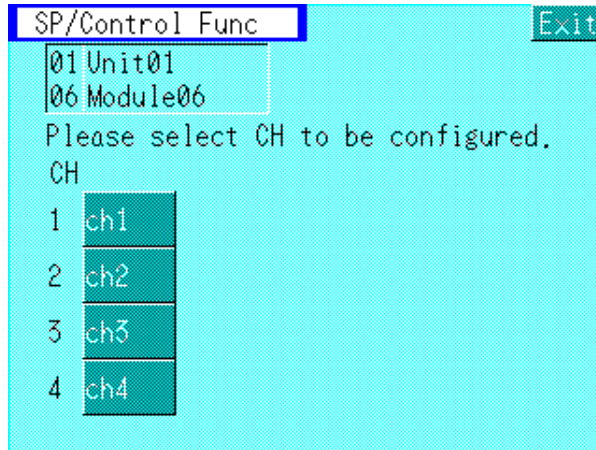

(2) When Heat/Cool control is available

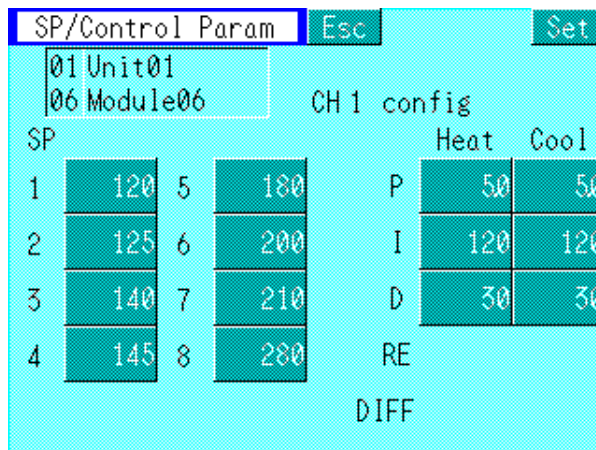

- If "Multi SP" of "Special Function" is "Dis", only one SP is displayed. and configurable.

! Handling Precautions

Setup the SP after setting up the input range and the SP range with the PV screen (p.6-4).

If the SP range is changed after the SP has been set, a Range Check will not be performed. Check the range by yourself and set the SP again if necessary.

■ DMC10 Monitor

This section describes DMC10's Monitor function.

The following chart shows the screen flow of the monitoring functions.

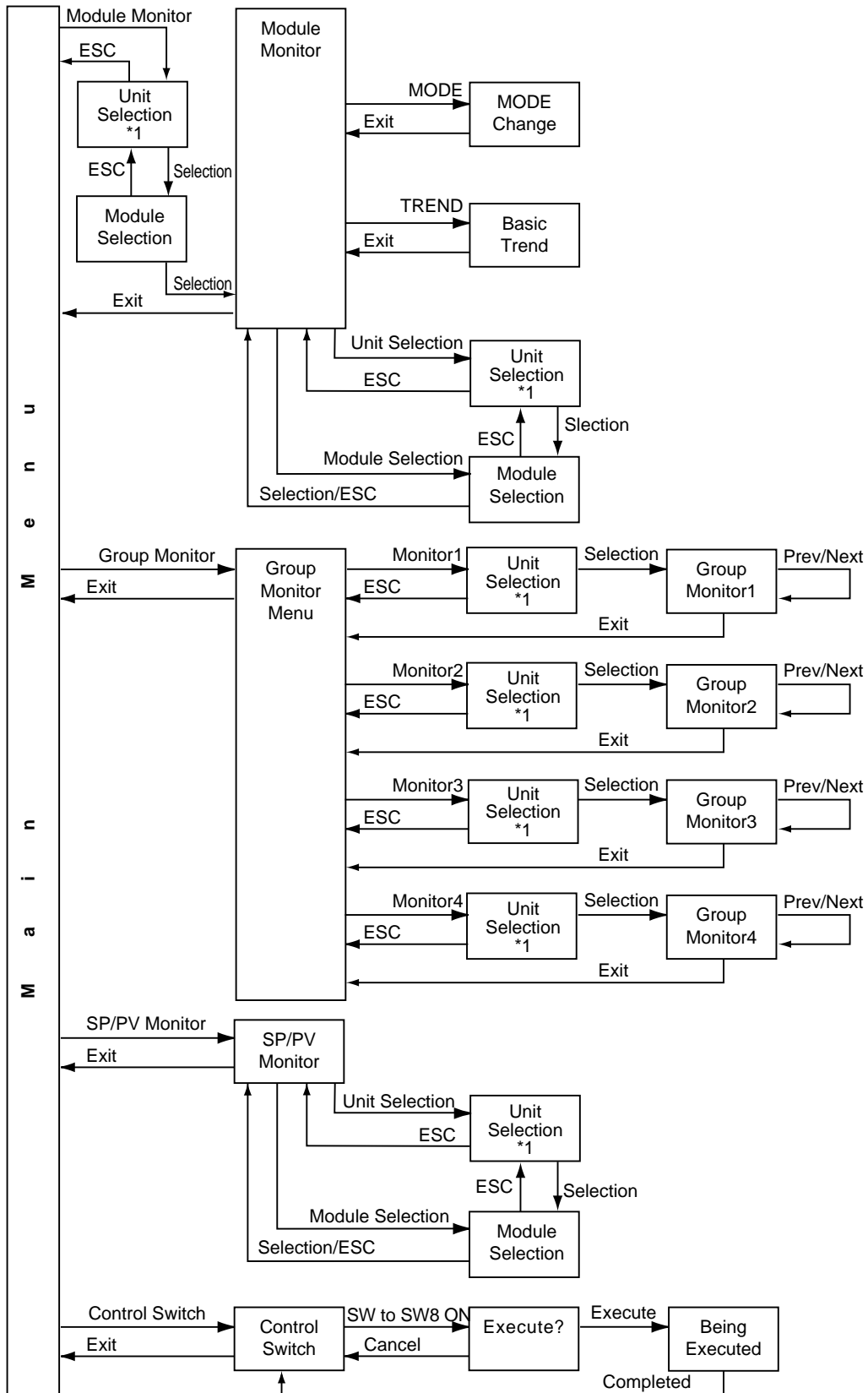

*1 : "Unit Selection" is not provided in the Direct-link version.

● **Module Monitor**

DMC10 can be monitored per module.

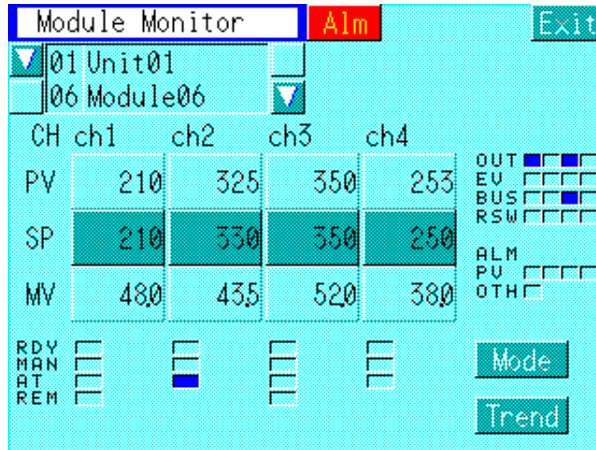

- Touch SP of each channel. The numeric keypad pops up. Input the desired SP value.
- In MANUAL mode, the numeric keypad pops up by touching the MV of each channel. Input the desired MV value.
- Touch [MODE] to go to the "Mode" screen.
- Touch [TREND] to go to the "Basic Trend" screen.

! **Handling Precautions**

Switches that have been set as "Dis" in the Package configuration will not respond.

The lamps indicate the following conditions.

Lamp	ON when.....
RDY	The CH is READY
MAN	The CH is in MANUAL mode
AT	The CH is executing AT (Auto tuning)
REM	The CH is in REMOTE mode
OUT	Output terminal of the CH is ON
EV	EVENT terminal is ON
BUS	BUS output is ON, This lamp indicates the event bus output status of each module, instead of the OR status of the BUS of the connected modules.
RSW	Remote switch input is ON
ALM (PV)	PV input of the CH is in error
ALM (OTH)	Other errors have occurred

● **Mode Change**

The MODE and AT start/stop of each channel can be changed with this screen.

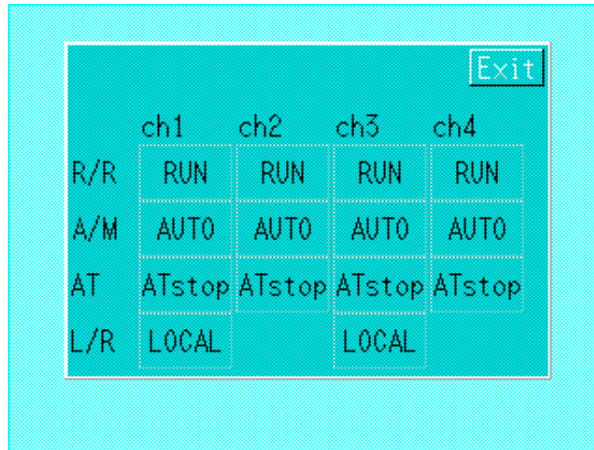

! Handling Precautions

Switches that have been set as "Dis" in the Package configuration will not respond.

● **Manual Motor Operation**

When position proportional control is being used without feedback (control type 3 or 4), the motor can be operated manually.

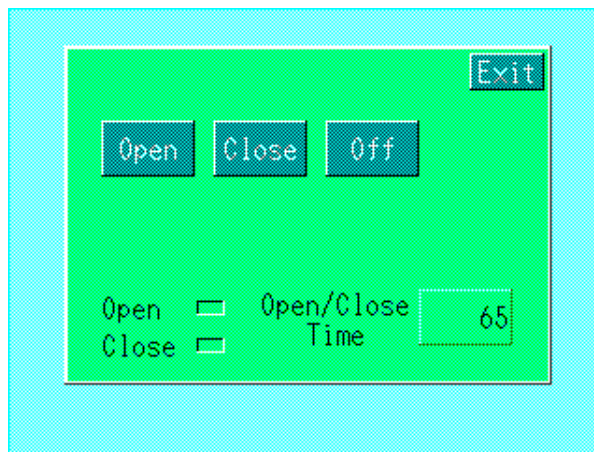

- After pressing [Open] or [Close] once, that state will continue until [Off] is pressed. Press [Off] once the motor comes to a halt.

● Basic Trend

PV&SP Trend or PV&MV Trend can be displayed with this function. Whether to display PV&SP or PV&MV is selected in the Package configuration.

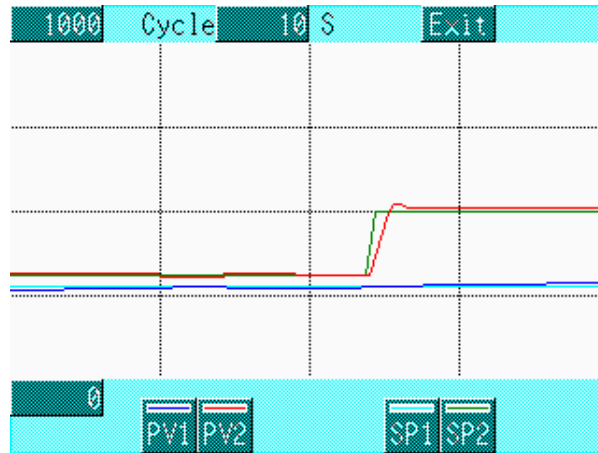

- To change the graph range, touch the graph range value. The numeric keypad pops up. Any value between -2000 and +10000 can be set. The initial value and decimal point of the graph range are the same as those of the CH1 input range.
- To change the cycle, touch the value of the cycle. The numeric keypad pops up. Any value between 1 and 10 (sec) can be set. (The initial value is 2 sec.)
- Touch PV or SP(or MV) switch to toggle the display of its graph ON/OFF.

! Handling Precautions

- Trend data is cleared after exiting out of the "Module Monitor".
- Trend data is cleared when the cycle is changed.
- To save the Trend data for a long time or to display only the desired channels use Trend Smart Objects in the User application.

● Group Monitor Menu

The Menu that has been registered in the Package configuration will be displayed.

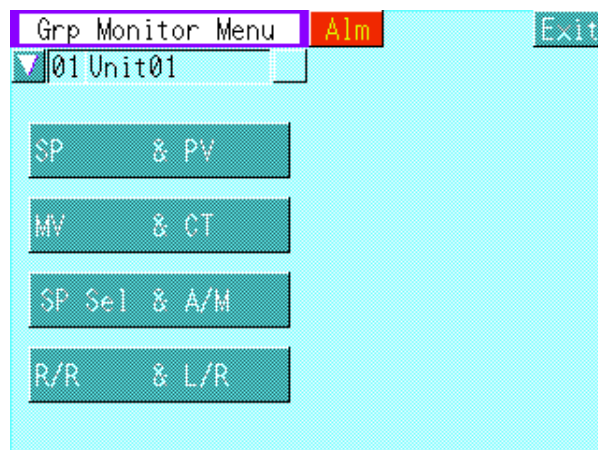

● **Group Monitor 1 to 4**

Touch an item in the Group Monitor Menu and select a "Unit Selection"(CMC link version only) to go to the "Group Monitor" screen. Data of four modules that have contiguous communication addresses are displayed.

Group Monitor					
01 Unit01					
				Prev	Next
01-02	PV	SP	03-04	PV	SP
U_H1	203	200	M_H4	250	250
U_H2	208	200	M_H5	252	250
U_H3	200	200	L_H1	270	270
U_H4	198	200	L_H2	271	271
M_H1_1	249	250	L_UP1	300	300
M_H1_2	250	250	L_UP2	301	300
M_H2	250	250	M_UP	300	300
M_H3	253	250	U_UP	298	300

- [Next] Touch to display the data of the next four modules.
- [Prev] Touch to display the data of the previous four modules.
- The numbers displayed above the CH name are the DMC10 communication addresses.

● **SP/PV Monitor**

This can select any two DMC10 modules and monitor their PV and SP.

SP/PV Monitor				
		CH	PV	SP
▼ 01 Unit01	<input type="checkbox"/>	U_H1	203	200
06 Module06	<input type="checkbox"/>	▼ U_H2	208	200
		U_H3	200	200
		U_H4	198	200
			PV	SP
▼ 03 Unit03	<input type="checkbox"/>	U_H1	203	200
09 Module09	<input checked="" type="checkbox"/>	▼ U_H2	208	200
		U_H3	200	200
		U_H4	198	200

- To select unit, touch ▼ on the left of the Unit Name. (CMC link version only)
- To select module, touch ▼ on the right of the Module Name.
- The selection of the modules is retained even after going to other screens. It is initialized when the EST240Z is turned off.

● Control Switch

Control Switches that have been defined in the Package configuration are displayed.

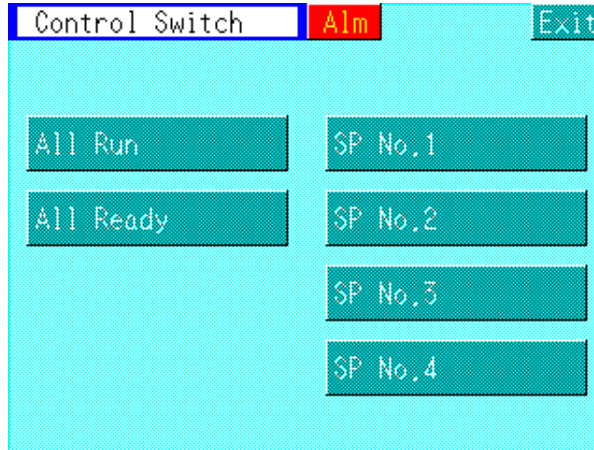

- Touch a switch to display its Confirmation screen. Touch [OK] to execute the control switch.

■ DMC10 Alarm Monitor

The alarms of the DMC10 can be checked with the [ALARM] lamp in the screens of "Main Menu", "Module Monitor", "Group Monitor" "SP/PV Monitor" and "Control Switch".

Touch [ALARM] to go to the Alarm Monitor.

The following chart shows the screen flow of the Alarm Monitor.

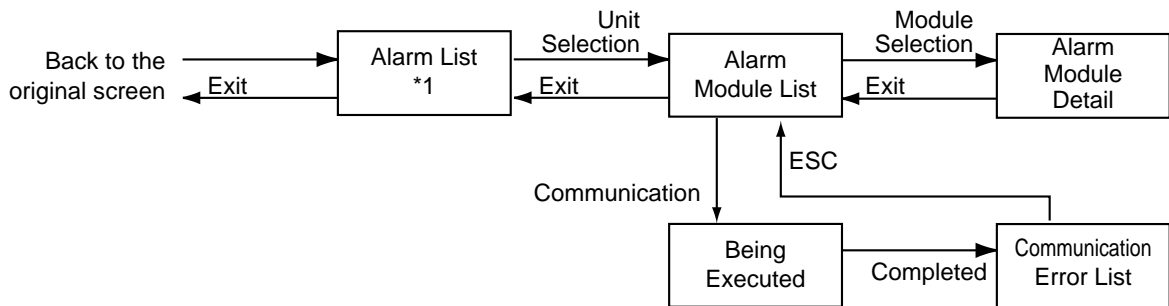

*1 : In the Direct link version, it goes directly to the "Alarm Mod List" by touching [ALARM].

● **Alarm List (CMC link version only)**

The modules that have errors are indicated with red lamps.

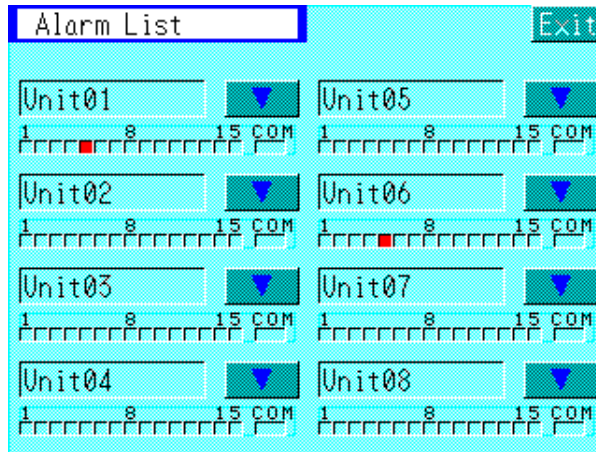

- When the "COM" lamp lights in red, it indicates that there is a communication error in that unit.
- Touch ▼ on the right of the Unit Name to go to the "Alarm Mod List".

● **Alarm Module List**

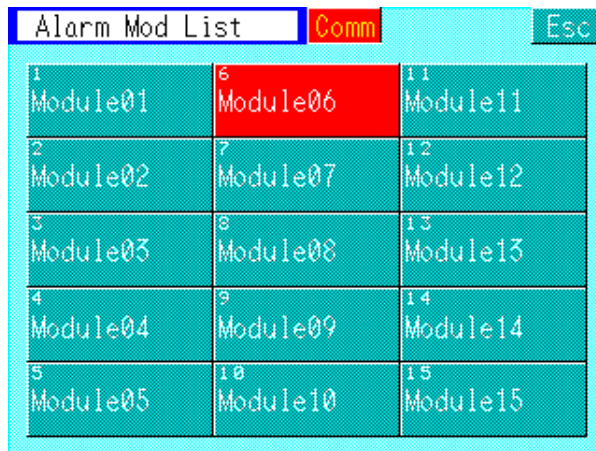

- The modules that have errors are indicated with red lamps. Touch a module to go to its "Alm Mod Detail".
- [COMM] lamp lights in red when communication error occurs. Touch [COMM] to go to the "Comms Error List".

● **Alarm Module Details**

The alarm details of each module are displayed.

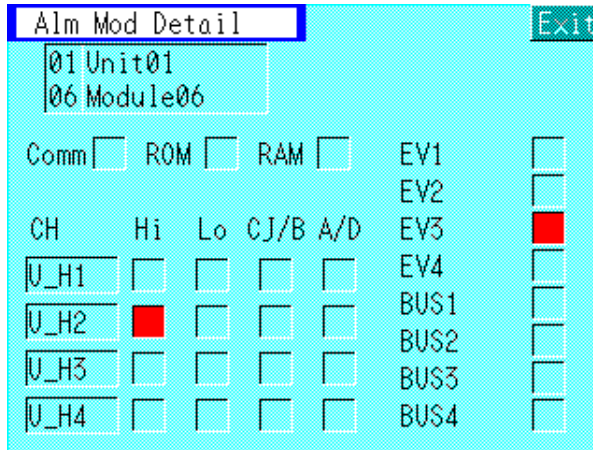

- The items that have an error are indicated with red lamps.
- On the right of the screen, the events that have been defined in the "Alarm Definition" of the Package configuration are displayed.

● **Communication Error List**

In the CMC link version, the module list of each unit is displayed.

In the Direct link version, all the modules are listed.

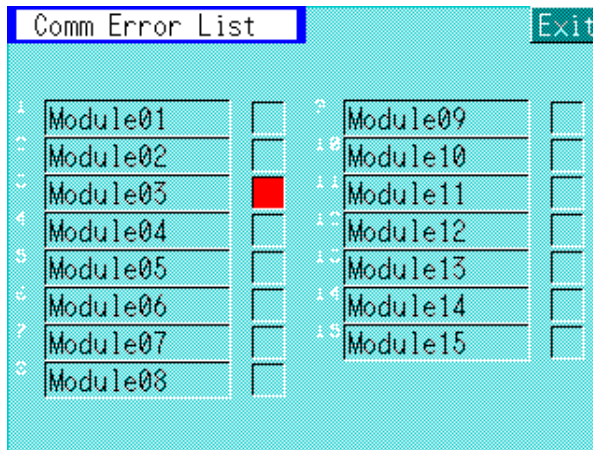

- The modules that have errors are indicated with red lamps.

Chapter 7. USAGE EXAMPLES - GATEWAY AND CONTROL SWITCH

This chapter describes examples using the high-level functions of EST240Z/CMC10B/DMC10.

■ PLC Data Exchange with the EST240Z Gateway Function

The EST240Z Gateway function is used when the EST240Z is connected with a PLC. With this function, the user can read DMC10 data such as PV and Events to the PLC and write settings such as SP from the PLC to the DMC10.

● In Direct link :

Function details are defined by [Configuration Information] - [Gateway] of the EST240Z AP Editor.

To read the DMC10 data to PLC :

DMC10 communication address and data address are specified in "Source device".

PLC communication address and register address are specified in "Destination device".

To write the data from PLC to DMC10:reverse the above.

PLC addresses are specified in "Source device".

DMC10 addresses are specified in "Destination device".

For detailed information on the Gateway function, see the following manual.

EST240Z Application User's Manual (Manual No.CP-SP-1088E)

! Handling Precautions

- EST240Z operation may slow down if the Gateway function is run often. In such a case, reduce the Gateway running frequency.
- To use the Gateway function, the user needs to create a User application and download it to the EST240Z together with the Package.

● In CMC link :

If the PV and SP of each CMC10B are set as "Enb" in the "CMC Buffer configuration" of the "Package configuration menu", the CMC10 performs cyclical reads of the SP and PV of the connected DMC10 units and saves them in the read data area. The alarm data is always saved in the read data area regardless of the configuration. EST240Z can then read the CMC10B data efficiently. For the SP and Comm DI1 to Comm DI4 of each DMC10, a write area is reserved in the CMC10B.

When data is transmitted from PLC to this area in one single operation, the CMC10B then writes that data to each DMC10. For the write operation, no configuration of the Package is required.

To read and write to the CMC10B data area, use the EST240Z Gateway function.

The Gateway function is defined by [Configuration Information] - [Gateway] of the EST240Z AP Editor.

To read the DMC10 data to PLC :

CMC10B communication address and read data area are specified in "Source device".

PLC communication address and register address are specified in "Destination device".

To write the data from PLC to DMC10:reverse to the above.

PLC addresses are specified in "Source device".

CMC10B address and write data area are specified in "Destination device".

For detailed information on the Gateway function, see the following manual.

EST240Z Application User's Manual (Manual No.CP-SP-1088E)

The read and write data area of CMC10B are listed in the following tables.

- CMC10B read data area (1421W to 1675W)

DMC10 Comm. address	Alarm DMC10 data 4001W	PV DMC10 data 1004-1007W	Current SP DMC10 data 1008-1011W	Curr. SP Sel DMC10 data 1012-1015W	Control status DMC10 data 4004-4005W	DI/DO status DMC10 data 1045-1046W
1	1421	1436-1439	1496-1499	1556-1559	1616-1617	1646-1647
2	1422	1440-1443	1500-1503	1560-1563	1618-1619	1648-1649
3	1423	1444-1447	1504-1507	1564-1567	1620-1621	1650-1651
4	1424	1448-1451	1508-1511	1568-1571	1622-1623	1652-1653
5	1425	1452-1455	1512-1515	1572-1575	1624-1625	1654-1655
6	1426	1456-1459	1516-1519	1576-1579	1626-1627	1656-1657
7	1427	1460-1463	1520-1523	1580-1583	1628-1629	1658-1659
8	1428	1464-1467	1524-1527	1584-1587	1630-1631	1660-1661
9	1429	1468-1471	1528-1531	1588-1591	1632-1633	1662-1663
10	1430	1472-1475	1532-1535	1592-1595	1634-1635	1664-1665
11	1431	1476-1479	1536-1539	1596-1599	1636-1637	1666-1667
12	1432	1480-1483	1540-1543	1600-1603	1638-1639	1668-1669
13	1433	1484-1487	1544-1547	1604-1607	1640-1641	1670-1671
14	1434	1488-1491	1548-1551	1608-1611	1642-1643	1672-1673
15	1435	1492-1495	1552-1555	1612-1615	1644-1645	1674-1675

- Alarm

DMC10 4001W Bit information data

2^{15}	2^{14}	2^{13}	2^{12}	2^{11}	2^{10}	2^9	2^8	2^7	2^6	2^5	2^4	2^3	2^2	2^1	2^0
16	15	14	13	12	11	10	9	8	7	6	5	4	3	2	1

Bit	Item	Value
1	Event 1 internal calculation result	0 : OFF 1 : ON
2	Event 2 internal calculation result	0 : OFF 1 : ON
3	Event 3 internal calculation result	0 : OFF 1 : ON
4	Event 4 internal calculation result	0 : OFF 1 : ON
5	Event 5 internal calculation result	0 : OFF 1 : ON
6	Event 6 internal calculation result	0 : OFF 1 : ON
7	Event 7 internal calculation result	0 : OFF 1 : ON
8	Event 8 internal calculation result	0 : OFF 1 : ON
9	PV error of channel 1	0 : OK 1 : Error
10	PV error of channel 2	0 : OK 1 : Error
11	PV error of channel 3	0 : OK 1 : Error
12	PV error of channel 4	0 : OK 1 : Error
13	Reserved	always 0
14	Checksum error in RAM (Parameter area)	0 : OK 1 : Error
15	Checksum error in RAM (Adjustment area)	0 : OK 1 : Error
16	Checksum error in EEPROM	0 : OK 1 : Error

• Control Status

(1) DMC10 4004W Bit information data

	2^{15}	2^{14}	2^{13}	2^{12}	2^{11}	2^{10}	2^9	2^8	2^7	2^6	2^5	2^4	2^3	2^2	2^1	2^0	
	16	15	14	13	12	11	10	9	8	7	6	5	4	3	2	1	
Bit	Item															Value	
1	PVCH1 AUTO/MANUAL mode															0 : AUTO	1 : MANUAL
2	PVCH1 RUN/READY mode															0 : RUN	1 : READY
3	PVCH1 RSP mode															0 : LOCAL	1 : REMOTE
4	PVCH1 AT mode (Auto tune)															0 : AT Stop	1 : AT Start
5	PVCH2 AUTO/MANUAL mode															0 : AUTO	1 : MANUAL
6	PVCH2 RUN/READY mode															0 : RUN	1 : READY
7	PVCH2 LOCAL/REMOTE mode															0 : LOCAL	1 : REMOTE
8	PVCH2 AT mode (Auto tune)															0 : AT Stop	1 : AT Start
9	PVCH3 AUTO/MANUAL mode															0 : AUTO	1 : MANUAL
10	PVCH3 RUN/READY mode															0 : RUN	1 : READY
11	Reserved															always 0	
12	PVCH3 AT mode (Auto tune)															0 : AT Stop	1 : AT Start
13	PVCH4 AUTO/MANUAL mode															0 : AUTO	1 : MANUAL
14	PVCH4 RUN/READY mode															0 : RUN	1 : READY
15	Reserved															always 0	
16	PVCH4 AT mode (Auto tune)															0 : AT Stop	1 : AT Start

(2) DMC10 4005W Bit information data

	2^{15}	2^{14}	2^{13}	2^{12}	2^{11}	2^{10}	2^9	2^8	2^7	2^6	2^5	2^4	2^3	2^2	2^1	2^0	
	16	15	14	13	12	11	10	9	8	7	6	5	4	3	2	1	
Bit	Item															Value	
1	PVCH1 Self-tuning correction/ correction standby															0 : correction	1 : correction standby
2	Reserved															always 0	
3	Reserved															always 0	
4	Reserved															always 0	
5	PVCH2 Self-tuning correction/ correction standby															0 : correction	1 : correction standby
6	Reserved															always 0	
7	Reserved															always 0	
8	Reserved															always 0	
9	PVCH3 Self-tuning correction/ correction standby															0 : correction	1 : correction standby
10	Reserved															always 0	
11	Reserved															always 0	
12	Reserved															always 0	
13	PVCH4 Self-tuning correction/ correction standby															0 : correction	1 : correction standby
14	Reserved															always 0	
15	Reserved															always 0	
16	Reserved															always 0	

! Handling Precautions

Data of only such items are gathered that are "Enb" in the "CMC Buffer Configuration" of the "Package Configuration Menu". .

When using more than one CMC10B, configuration must be performed separately for each CMC10B.

- CMC10 write data area (1676W to 1795W)

DMC10 Comm. address	Current SP DMC10 Data 5008-5011	Comm.DI1 to 4 DMC10 Data 5101-5104
1	1676-1679	1736-1739
2	1680-1683	1740-1743
3	1684-1687	1744-1747
4	1688-1691	1748-1751
5	1692-1695	1752-1755
6	1696-1699	1756-1759
7	1700-1703	1760-1763
8	1704-1707	1764-1767
9	1708-1711	1768-1771
10	1712-1715	1772-1775
11	1716-1719	1776-1779
12	1720-1723	1780-1783
13	1724-1727	1784-1787
14	1728-1731	1788-1791
15	1732-1735	1792-1795

! Handling Precautions

- Data written to the above area will be written to the DMC10 EEPROM.
- Writing to Comm. DI1 to 4 is not possible when the EST Info of the DMC10 is less than "4".
- Errors occurring between CMC10B and DMC10 cannot be detected by the Gateway function, that writes the data from PLC to DMC10 through CMC10B. The errors that can be detected by the Gateway function are the errors occurring between the PLC, EST240Z and CMC10B.

To check if the data has been written to the DMC10 correctly, use other measures such as comparing the data written from PLC and the data read after a certain time.

- EST240Z operation may slow down if the Gateway function is run often. In such a case, reduce the Gateway running frequency.

■ Control DMC10 using the Control switch

The following example shows how to change RUN/READY of all the connected DMC10 using the Control switch.

The Package should be configured as follows.

Step(1) : Touch [Display Conf. Menu] of the [Pkg Config. Menu], then [Control Switch]. Set the SW1 and SW2 as "Enb".

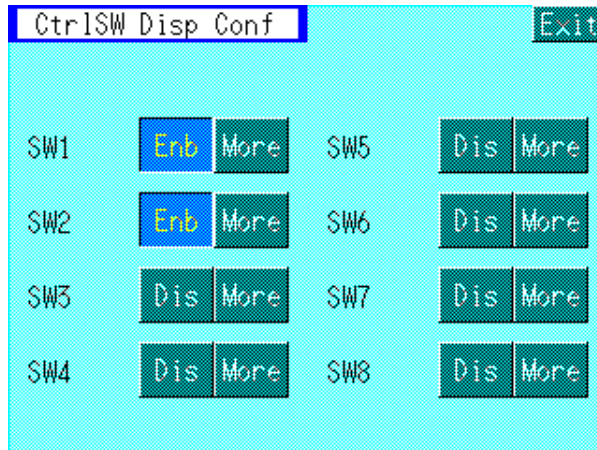

Step(2) : Touch [More] of SW1 to go to its [Ctrl. Sw. Define] screen. Set the [SW Name] and [Type] as in the following example.

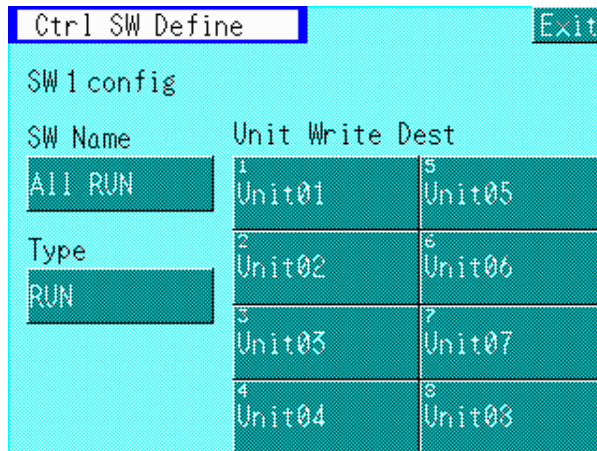

Step(3) : To operate all the DMC10 in one operation, press[All ON] for each unit. If separate operation to some CH is necessary, set OFF/ON of those CH separately.

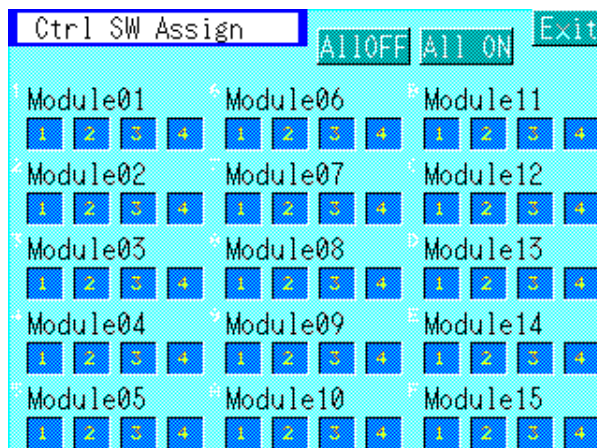

Step(4) : Touch [More] of SW2 in the screen of Step(1) to go to its [Ctrl. Sw. Define]. Set the [SW Name] and [Type] as in the following example.

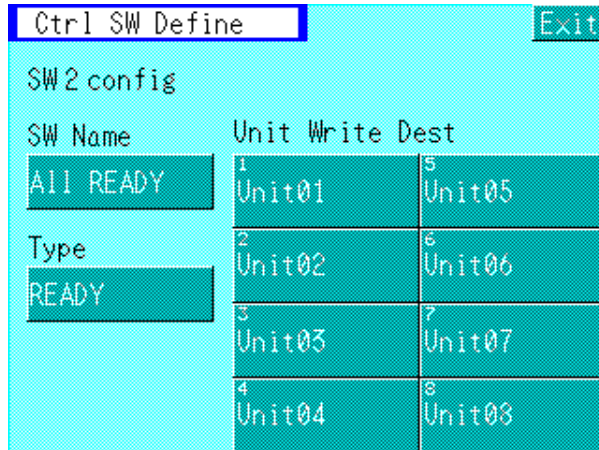

Step(5) : Configure the same as in Step(3). Now preparation is completed.

To check the operation, touch [Control switch] in the Main Menu. The following screen should appear.



- [All RUN] To RUN all the DMC10 at once.
- [All READY] To make all the DMC10 READY at once.

Chapter 8. COMBINED USE WITH USER APPLICATION

In addition to the functions of the Package, users can create their own application screens.

For information on how to create a User application, see the following manual.

EST240Z Application User's Manual (Manual No.CP-SP-1088E)

When turning the power on after downloading both a User application and a Package, screen 1(panel 1) of the User application will start.

To go to the Package screen, attach a "Panel Change" object on any desired screen of the User application.

Select "Dedicated Package Change" as the parameter type, when configuring the object.

Touch this object to go to the Main menu of the Package.

To go back to the User application from, the Package, touch "Exit" on the Main menu screen of the Package.

! Handling Precautions

- When calling up the Package, the screen size should be the whole screen size (320x240 dot).
- Do not call up the Package when more than one screen is already opened. Since when returning from the Package, only one screen can be started again.
- If starting the "Dedicated Package Change" with "External Execution", do not attach it to the back ground panel. Since the user panel will not be able to be started when returning from the Package.

The background panel of the User application is running even while the Package is being operated.

The user can select whether, or not, to let the Package monitor DMC10 alarms while the User application is being operated as follows: Go to "Alarm Definition" of the Package configuration menu.

Select "Enb/Dis" of the "Pkg Alm with User Apli"..

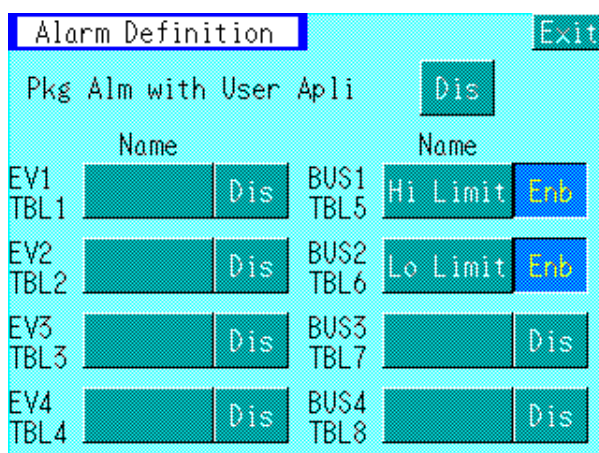

● Illustration of transition between Package and User application

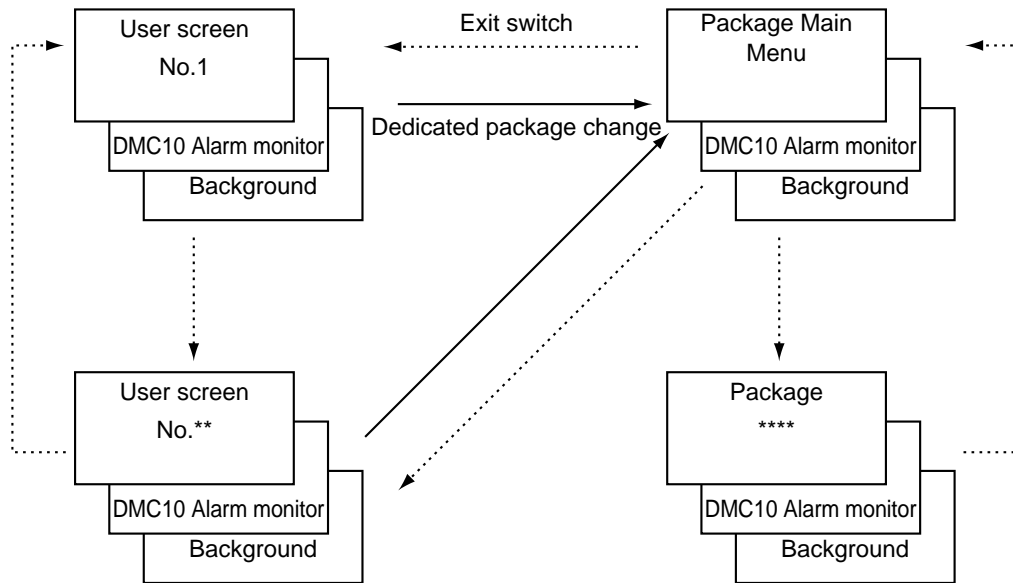

● Package status devices that can be checked from the User application

The operation status of the Package can be checked from the User application. The devices that can be checked are as follows.

Status device	Name	Description
TR800010.2	DMC10 Alarm Monitor	0 : Not monitoring 1 : Monitoring
TR800010.8	CMC Buffering Error (CMC link version only)	0 : No error 1 : Error
TR800011.0	DMC10 Alarms	0 : No Alarm 1 : Alarm Valid only when the Alarm monitor is active during the User application's operation.

Chapter 9. TROUBLESHOOTING

Problems can be divided into the following categories.

- Package related
- DMC10 related

■ Package Troubleshooting

● Error message appears on the package display

Error messages that appear on the package display, their causes and appropriate counter measures are as follows.

Error Message	Cause	Counter measure
Auto device assignment has not been performed, can't commence communications. Please perform auto device assignment.	Device configuration is unknown, since auto device assignment has not been performed.	Perform "Auto device assignment" of the "Package Configuration Menu".
No DMC10 devices could be assigned. Please verify wiring and configuration, then retry.	No valid DMC10 was detected through auto device assignment.	Check communication settings of each device. Check the wiring of the cables. Perform auto device assignment again.
DMC package does not support this module. Auto assignment can't be performed.	The version of the DMC10 is not supported by the Package.	Change the DMC10 unit for one with the version that is supported by the Package.
WRITE destination not specified. Please specify, then retry.	The write destination of the control switch has not been specified.	Setup the type and assignment with "Package Configuration Menu" - "Disp. Conf. Menu" - "Control Switch".
Error reading data from module.	<ul style="list-style-type: none"> • Data cannot be read because of DMC10 failure or communication error. • The target module is different from the module that was registered by the auto device assignment. 	<ul style="list-style-type: none"> • Check the wiring of the cables. • Perform Auto device assignment again, if the device configuration has been changed.
Error writing data to module.	<ul style="list-style-type: none"> • Data cannot be written because of DMC10 failure or communication error. • The target module is different from the module that was registered by the auto device assignment. • One of the following items of the target module was changed by the PC loader after auto device assignment: Input type, decimal point position, PV range lower limit, PV range upper limit, SP lower limit, SP upper limit 	<ul style="list-style-type: none"> • Check the wiring of the cables. • Perform Auto device assignment again, if the device configuration has been changed.
Start-up processing failed. Please reset the power to the modules, or perform device auto-assignment. (ONLY CMC-LINK TYPE)	• CMC Buffer configuration failed.	<ul style="list-style-type: none"> • Check the wiring of the cables • Check if the power is supplied correctly to the CMC10B. Reboot EST240Z. • Perform Auto device assignment again, if the device configuration has been changed.

● Other troubleshooting

Troubles	Cause	Counter measure
MODE or SP/MV that have been changed by Module monitor are not reflected to DMC10 screens.	Write cannot be accepted owing to the DMC10 operation status. ex.: MANUAL change during ON/OFF control, RUN/READY is defined by RSW input	Modify the settings to match the DMC10 operation status.
Error messages are displayed when executing Control switches.	<ul style="list-style-type: none"> • Write cannot be accepted owing to the DMC10 operation status. e.g.: MANUAL change during ON/OFF control, SP number change when the Multi SP group is not used, SP No. 5 to 8 in 4CH model • Write destination of the Control switches has not been specified. 	Modify the settings to match the DMC10 operation status.

■ DMC10 Troubleshooting

When DMC10 alarms occur, use "Alarm List" screen or "Alm Mod Detail" screen to check where the alarms are occurring and the details of the alarms.

For information on the cause and counter measures for each alarm, see the following DMC10 manual.:

Module Controller DMC10 Description of Function Manual
(Manual No. CP-UM-5143E)

Specifications are subject to change without notice.

YAMATAKE

Yamatake Corporation

Control Product Division

Sales contact: Yamatake Corporation,

IBD Sensing and Control Department

Totate International Building

2-12-19 Shibuya Shibuya-ku Tokyo 150-8316 Japan

Phone: 81-3-3486-2380

Fax: 81-3-3486-2300

This has been printed on recycled paper.

Printed in Japan.

1st Edition: Issued in Jan., 2001(C)

2nd Edition: Issued in Mar., 2001(C)