

# DigitroniK™

## Digital Indicating Controller

### SDC45A/46A

The SDC45A/46A DigitroniK (hereafter C45A or C46A) is a highly advanced, high-precision compact digital indicating controller, featuring dual 5-digit indicators, an input sampling cycle of 25ms, indication accuracy of  $\pm 0.1\%$  of reading, and up to 2 control loops. It offers PID control using the latest "RationalLOOP" and "Just-FiTTER" algorithms.

Up to seven control outputs (depending on the model) are available, selectable from relay contact, voltage pulse, triac (for position proportional output), current, continuous voltage, and transmitter power (24Vdc).

Additionally, the controller can be configured with as many as 14 digital inputs (DIs) and 8 digital outputs (DOs). A mode change function to handle automatic equipment operation, a variety of alarms, and various status outputs are provided to support safe operation. Easy setup and monitoring from a PC are available using the Smart Loader Package.

This controller is compliant with IEC directives, and is CE-marked.

#### ■ Features

- Control, ranging from cascade to backup control, is available for 1 or 2 loops.
- High-speed 25ms sampling cycle and accuracy of  $\pm 0.1\%$  rdg.
- Ample room for indication of vital information on dual 7-segment, 5-digit LED displays and an auxiliary 11-segment, 3-digit LED display



- Full multi-range input, allowing input type to be freely changed between thermocouple, RTD, current and voltage
- Heat/cool control, using two control outputs
- Using the optional transmitter power supply function, a pressure transmitter can be directly connected.
- IP65 protection for the front panel
- Up to 16 recipe settings involving SP, event settings, etc., and 8 groups of fixed-value control output settings support automatic operation of equipment.
- Support for nonlinear processes using input/output broken line linear approximation tables
- Customizable parameter keys and LED
- A variety of inputs and outputs  
2 inputs, 7 outputs, 14 DIs, 8 DOs, 2 CT or AT inputs, RS-485 communications
- RoHS-compliant

#### ■ Basic Function Block Diagram for the C45A/46A

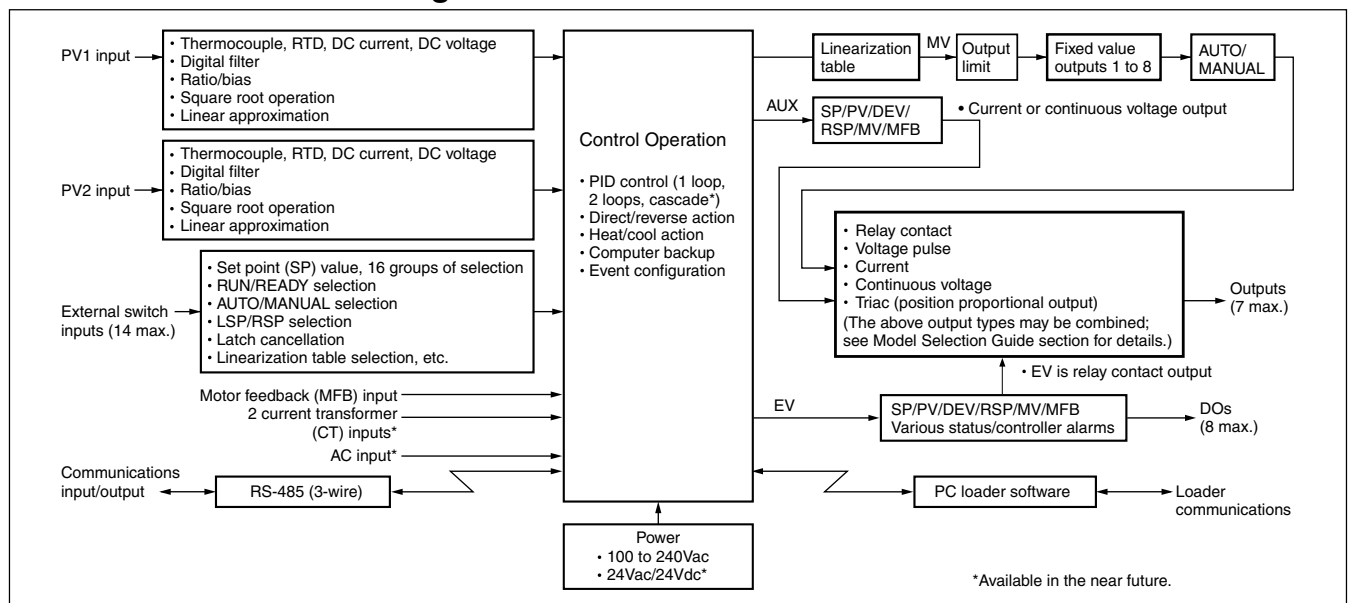

## ■ Specifications

<b>Analog input</b>	Input type	Full multi-range input: thermocouple, RTD, DC current and DC voltage
	Input sampling time	25ms, 50ms, 100ms, 300ms (according to the setting)
	Input bias current (under standard conditions)	Thermocouple input: -0.2 $\mu$ A (upscale burnout indication) +0.13 $\mu$ A (downscale burnout indication) $\pm$ 0.05 $\mu$ A (no burnout detection) Note: Negative current flow is from terminal B, positive is to terminal B. DC voltage input: -0.2 $\mu$ A in the $\pm$ 100mV range and lower ranges (upscale burnout indication) +0.13 $\mu$ A in the $\pm$ 100mV range and lower ranges (downscale burnout indication) $\pm$ 0.05 $\mu$ A in the $\pm$ 100mV range and lower ranges (burnout detection) $\pm$ 1 $\mu$ A or less in the 0 to 1V and -1 to +1V ranges -5 $\mu$ A or less in the 1 to 5V and 0 to 5V ranges -10 $\mu$ A or less in the 10V range
	Input impedance	Current input: 110 $\Omega$ or less
	Measuring current	RTD input: 1.0mA $\pm$ 2%
	Influence of wiring resistance (under standard conditions)	Thermocouple input: 0.2 $\mu$ V/ $\Omega$ (upscale burnout indication) 0.13 $\mu$ V/ $\Omega$ (downscale burnout indication) 0.05 $\mu$ V/ $\Omega$ (no burnout detection) DC voltage input: 0.2 $\mu$ V/ $\Omega$ or less in the $\pm$ 100mV range and lower ranges (upscale burnout indication) 0.13 $\mu$ V/ $\Omega$ or less in the $\pm$ 100mV range and lower ranges (downscale burnout indication) 0.05 $\mu$ V/ $\Omega$ in the $\pm$ 100mV range and lower ranges (burnout detection) 1 $\mu$ V/ $\Omega$ or less in the 0 to 1V and -1 to +1V ranges 5 $\mu$ V/ $\Omega$ or less in the 1 to 5V and 0 to 5V ranges and lower ranges 10 $\mu$ V/ $\Omega$ or less in the 10V range and lower ranges
	RTD input allowable wiring resistance	85 $\Omega$ or less (Zener barrier + wire, per wire)
	Max. allowable input	Thermocouple input, DC voltage input (in the 100mV range and lower ranges): -1.0 to +2.5Vdc
	Burnout indication	Varies with input range
	Over-range detection threshold	Varies with upper/lower limit value of PV range or input range (fixed)
	Cold junction compensation accuracy	$\pm$ 0.5 $^{\circ}$ C (under standard conditions)
	Infl. of ambient temp. on cold junction compensation	$\pm$ 1.0 $^{\circ}$ C (in the 0 to 50 $^{\circ}$ C range under standard conditions)
	Cold junction compensation method	Internal/external (0 $^{\circ}$ C only) compensation selectable
	Scaling	-19999 to +32000U (Linear DC voltage/current input only. Reverse scaling and decimal point repositioning available. Effective resolution depends on the range.)
<b>Indicators and configuration</b>	PV, SP indication	5-digit, 7-segment LED. PV: green or orange (depending on the model) upper display. SP: lower orange display.
	Auxiliary indication	3-digit, 11-segment orange LED
	Multi-status indicator	12-segment LED, green or orange (depending on the model). Displays status of control output, alarm, RUN/READY, etc.
	No. of status displays	C45A: 17, C46A: 19 LED displays
	Operation keys	C45A: 11, C46A: 13 rubber keys
	Number of local set points	16 groups
	Memory storage system	EEPROM
	Indicating range	-19999 to +32000U (or to the SP limit, if it is set)
	SP limits	Lower limit: -19999 to upper limit value. Upper limit: lower limit value to 32000U.
	SP ramp	0.0 to 3200.0s, min, or h (both up- and down-ramp), Disabled if 0.0 is selected.
	Input readout accuracy	$\pm$ 0.1% FS $\pm$ 1 digit (depending on the range; see Table 1)
	Indicating range	See Table 1
<b>Digital input (DI)</b>	Number of inputs	C45A: 10 max. C46A: 14 max.
	Types of connectable outputs	Dry contact or open-collector (open drain, sink)
	Open terminal voltage	7 Vdc $\pm$ 15% (under standard conditions)
	Terminal current (during short-circuit)	3 to 5 mA (optional 8 or 12 inputs under standard conditions), 3 to 7mA (standard 2 inputs under standard conditions)
	Allowable contact resistance (dry contact)	500 $\Omega$ or less (under standard conditions)
	Allowable open-collector ON-state residual current	1.5V or less (under standard conditions)
	Allowable open-collector OFF-state leakage current	100 $\mu$ A or less (under standard conditions)
	Sampling cycle	25ms
	Computation cycle	25ms, 50ms, 100ms, 300ms (depending on the setting)
	Min. detection holding time	2 times the input sampling cycle
	Assignable functions	RUN/READY, AUTO/MANUAL, REMOTE/LOCAL, auto tuning start/stop, control action direct/reverse selection, SP group/recipe group selection, fixed value outputs 1 to 8 selection, linear approximation table selection, computer backup selection

<b>Control</b>	PID control	Proportional band (P)	0.1 to 3200.0%
		Integral time (I)	0 to 32000, 0.0 to 3200.0, 0.00 to 320.00 seconds
		Derivative time (D)	0 to 32000, 0.0 to 3200.0, 0.00 to 320.00 seconds
		MV limit	Lower limit: -10.0 to upper limit % Upper limit: lower limit to +110.0%
		Manual reset	-10.0 to +110.0%
		Number of PID groups	16
		PID group selection	By console or DI
		MV change limit	0.00 to 320.00%/s, no limit at 0.0%
		Auto tuning	Automatic PID value setting by limit cycle method. Additionally, one of the following 3 control characteristics can be selected: <ul style="list-style-type: none"> <li>• Standard</li> <li>• Quick disturbance response</li> <li>• Less up/down fluctuation</li> </ul>
	Position proportional dead zone	0.5 to 25.0%	
Heat/cool dead zone	-100.0 to +100.0%		
Direct/reverse action selection	Available		
<b>Output</b>	Relay contact, form 1a1b (outputs 1 & 2)	Contact rating: 250Vac/30Vdc, 3A (resistive load) Contact voltage: 250Vac or less / 125Vdc or less Service life: 100,000 cycles or more (under rated conditions) Min. switching specifications: 100mA/5Vdc	
	Relay contact, form 1a (outputs 1 & 2)	Contact rating: 250Vac/30Vdc, 1A (resistive load) Contact voltage: 250Vac or less / 110Vdc or less Service life: 100,000 cycles or more (under rated conditions) Min. switching specifications: 10mA/5Vdc	
	Relay contact, form 1a (outputs 3 to 5)	Contact rating: 250Vac/30Vdc, 3A (resistive load) Contact voltage: 250Vac or less / 125Vdc or less Service life: 100,000 cycles or more (under rated conditions) Min. switching specifications: 100mA/5Vdc	
	Triac (outputs 3 & 4, position proportional output)	Compatible motors: ECM3000*11*0 (100Vac type) ECM3000F1200 (100Vac type)	
	Current (outputs 3 to 7)	Output current: 4 to 20mA <sub>dc</sub> (2.4 to 21.6mA <sub>dc</sub> ) 0 to 20mA <sub>dc</sub> (0.0 to 22.0mA <sub>dc</sub> ) Load resistance: 600Ω or less Output accuracy: ±0.1% FS or less (under standard conditions) Output resolution: 1/15000 or more (in the 0 to 20mA <sub>dc</sub> FS range) Voltage (open): 23Vdc or less	
	Voltage pulse	Output voltage: 12Vdc±15%/-10% Load current: 30mA or less	
	Continuous voltage	Output voltage: 0 to 5Vdc (0.0 to 5.5Vdc) 1 to 5Vdc (0.6 to 5.4Vdc) 0 to 10Vdc (0.0 to 11.0Vdc) Load resistance: 1kΩ or more Load limit current: 12mA or more Output accuracy: ±0.1% FS or less (under standard conditions) Output resolution: 1/20000 or more (in the 1 to 10Vdc FS range)	
	Transmitter power supply function	Output voltage: 24Vdc±10% Load current: 30mA or less Load limit current: 45mA	
<b>Digital Output (DO)</b>	Event types (assignable to relay output)	PV direct, PV reverse, deviation direct, deviation reverse, absolute value deviation direct, absolute value deviation reverse, MV direct, MV reverse, RSP direct, RSP reverse, SP direct, SP reverse, sum of all alarms, PV range alarm, controller alarm, manual status, READY status, local status, auto tuning execution	
	Settable ranges	PV (direct, reverse): -19999 to +32000U RSP (direct, reverse): -19999 to +32000U Deviation (direct, reverse): -19999 to +32000U Absolute value deviation (direct, reverse): 0 to +32000U MV (direct, reverse): -10.0 to +110.0%	
	Operation differential (hysteresis) setting range	0 to 200U (except MV, MFB event, process alarm) 0.0 to 20.0% for MV, MFB event, process alarm	
	ON delay time	0.1 to 3200.0 seconds	
	Output operation	ON/OFF action, latch action	
	Output rating	Output type: open-collector (open drain) sink method Load resistance: 4.5 to 28Vdc Load current: 70mA/output max. 500mA/all outputs max.	
<b>Auxiliary output</b>	Number of outputs	4 max. assignable	
	Output types	PV, SP, DEV, RSP, MV, MFB, etc. can be selected	
	Output method	Current or continuous voltage	

<b>Communications</b>	Communications system	Protocol	RS-485	
		Network	Multidrop. Slave station only. Connect up to 31 units.	
		Data flow	Half-duplex	
		Synchronization method	Start/stop synchronization	
	Interface	Transmission system	Balance (differential) type	
		Transmission type	Bit serial	
		Transmit/receive lines	3	
		Speed	4800, 9600, 19200, 38400 bps	
		Distance	500m max.	
		Protocol	RS-485 (3-wire type)	
	Message characters	Character configuration	9 to 12 bits/character	
		Data length	7 or 8 bits	
		Stop bit length	1 or 2 bits	
Parity bit		Even parity, odd parity, or non-parity		
<b>PC loader</b>	Communications line	3-wire type		
	Communications speed	38400 bps (fixed)		
	Recommended cable	Dedicated cable		
<b>Current transformer (CT) input</b>	Number of inputs	2		
	Detection function	When control output is ON: heater line break or overcurrent detection When control output is OFF: final control device short circuit detection		
	Input device	Current transformer (sold separately), 800 turns • QN212A, 5.8mm dia. hole • QN206A, 12mm dia. hole		
	Input range	AC 0.0 to 50.0A		
	Measurement current range	AC 0.4 to 55.0A		
	Indication accuracy	±3% FS ± 1 digit (AC 0.4A or more, under other standard conditions, excluding CT accuracy)		
	Indication resolution	AC 0.1A		
<b>General specifications</b>	Memory backup	EEPROM		
	Power	100 to 240Vac, 50/60Hz ± 2Hz		
	Power consumption	C45A: 30VA or less. (100 to 240Vac power model) C46A: 40VA or less. (100 to 240Vac power model)		
	Power ON inrush current	35A or less/10ms or less (100 to 240Vac power model)		
	Power ON operation	Reset time: 6s max. (time until normal operation starts under standard conditions)		
	Allowable transient power loss	20ms or less		
	Insulation resistance	20MΩ or more between power supply terminal 1 or 2 and FG terminal 3 (500Vdc megger)		
	Dielectric strength	1500Vac for 1min (100 to 240Vac power model)		
		• Between power supply terminal 1 or 2 or FG terminal 3 and secondary terminal • Between power supply terminal 1 or 2 and FG terminal 3		
	Standard conditions	Ambient temperature	23±2°C	
		Ambient humidity	60±5% RH	
		Power voltage	105Vac±1%	
		Power frequency	50±1Hz or 60±1Hz	
		Vibration resistance	0m/s <sup>2</sup>	
		Shock resistance	0m/s <sup>2</sup>	
		Mounting angle	Reference plane ±3°	
		Clear space	100mm min. vertically and horizontally	
	Operating conditions	Ambient temperature	0 to 50°C	
		Ambient humidity	10 to 90% RH (without condensation)	
		Power voltage	85 to 264Vac	
		Power frequency	50±2Hz or 60±2Hz	
		Vibration resistance	0 to 2m/s <sup>2</sup> (10 to 60Hz for 2h each in X, Y, and Z directions)	
		Shock resistance	0 to 10m/s <sup>2</sup>	
		Mounting angle	Reference plane ±10°	
		Altitude	2000m max.	
	Transportation conditions	Clear space	50mm min. above and below	
		Ambient temperature	-20 to 70°C	
		Ambient humidity	10 to 95% RH (without condensation)	
		Vibration resistance	0 to 5m/s <sup>2</sup> (10 to 60Hz for 2h each in X, Y, and Z directions)	
		Shock resistance	0 to 500m/s <sup>2</sup> (3 times each in X, Y, and Z directions)	
		Front panel protection	IP65	
		Console and case material	Polyphenylene oxide	
		Console and case color	Black	
		Standards compliance	EN61010-1 (CE-LVD), EN61326 (CE-EMC), RoHS	
		Overvoltage category	Category II (IEC60364-4-443, IEC60664-1)	
		Mounting	Panel mounted (with dedicated mounting bracket)	
	Mass	C45A: Approx. 400g (including dedicated mounting bracket) C46A: Approx. 700g (including dedicated mounting bracket)		

Accessories (included)	Part name	Model	Optional parts (sold separately)	Part name	Model
	Mounting brackets (2)	<b>81405411-004</b>		Mounting brackets (2)	<b>81405411-003</b>
	Gasket	<b>81421863-001</b> (for C45A)		Current Transformer	<b>QN206A</b> (5.8mm dia. hole)
		<b>81421864-001</b> (for C46A)			<b>QN212A</b> (12mm dia. hole)
User's manual	<b>CP-UM-5445E</b>	Hard cover	<b>81441421-001</b> (for C45A)		
			<b>81441422-001</b> (for C46A)		
		Terminal cover	<b>81441420-001</b> *		

\* 1 for C45A, 2 for C46A

**Table 1 Input Types and Ranges**

Input type	Pv-01	Sensor type	Range		Accuracy
Thermocouple	1	K	-270.0 to +1372.0°C	-454 to +2502°F	±0.1% rdg. ±1 digit <sup>*1</sup>
	2	E	-270.0 to +1000.0°C	-454 to +1832°F	±0.1% rdg. ±1 digit <sup>*2</sup>
	3	J	-200.0 to +1200.0°C	-328 to +2192°F	±0.1% rdg. ±1 digit <sup>*3</sup>
	4	T	-270.0 to +400.0°C	-454 to +752°F	±0.5°C <sup>*4</sup>
	5	B	0.0 to 1800.0°C	32 to 3272°F	±2.0°C <sup>*5</sup>
	6	R	-50.0 to +1768.0°C	-58 to +3214°F	±0.1% rdg. ±1 digit <sup>*6</sup>
	7	S	-50.0 to +1768.0°C	-58 to +3214°F	±0.1% rdg. ±1 digit <sup>*6</sup>
	8	W (WRe5-26)	0.0 to 2300.0°C	32 to 4172°F	±0.1% rdg. ±1 digit <sup>*7</sup>
	9	PR40-20	0.0 to 1900.0°C	32 to 3452°F	±8.0°C <sup>*8</sup>
	10	Ni-NiMo	0.0 to 1300.0°C	32 to 2372°F	±1.4°C
	11	N	-200.0 to +1300.0°C	-328 to +2372°F	±1.4°C <sup>*9</sup>
	12	PL II	0.0 to 1390.0°C	32 to 2534°F	±1.4°C
	13	DIN U	-200.0 to +600.0°C	-328 to +1112°F	±0.7°C <sup>*10</sup>
	14	DIN L	-200.0 to +900.0°C	-328 to +1652°F	±1.0°C <sup>*11</sup>
	15	Golden-iron/Chromel	-273.0 to +27.0°C	-459 to +80°F	±1.5°C

\*1: At 400°C and above.  
±0.5°C (< +400 to -100°C)  
±1.0°C (< -100 to -200°C)  
±20.0°C (< -200°C)

\*2: At 400°C and above.  
±0.5°C (< +400 to -100°C)  
±1.0°C (< -100 to -200°C)  
±15.0°C (< -200°C)

\*3: At 400°C and above.  
±0.5°C (< +400 to -100°C)  
±1.0°C (< -100°C)

\*4: At -100°C and above.  
±1.0°C (< -100 to -200°C)  
±10.0°C (< -200°C)

\*5: At 800°C and above.  
±4.0°C (< 800 to 260°C)  
±70°C (< 260°C)

Input type	Pv-01	Sensor type	Range		Accuracy
RTD	21	Pt100	-200.0 to +850.0°C	-328.0 to +1562.0°F	±0.3°C
	22		-200.00 to +300.00°C	-328.00 to +572.00°F	±0.15°C
	31	JPt100	-200.0 to +640.0°C	-328.0 to +1184.0°F	±0.3°C
	32		-200.00 to +300.00°C	-328.00 to +572.00°F	±0.15°C
Linear (DC voltage /current)	41	Current	4 to 20mA		±0.1% FS ±1 digit
	42		0 to 20mA		±0.1% FS ±1 digit
	43	Voltage	0 to 10mV		±0.1% FS ±1 digit
	44		-10 to +10mV		±0.1% FS ±1 digit
	45		0 to 100mV		±0.1% FS ±1 digit
	46		-100 to +100mV		±0.1% FS ±1 digit
	47		0 to 1V		±0.1% FS ±1 digit
	48		-1 to +1V		±0.1% FS ±1 digit
	49		1 to 5V		±0.1% FS ±1 digit
	50		0 to 5V		±0.1% FS ±1 digit
	51		0 to 10V		±0.1% FS ±1 digit

\*6: At 1000°C and above.  
±2.0°C (< 1000°C to 0°C)  
±4.0°C (< 0°C)

\*7: At 1400°C and above.  
±1.5°C (< 1400°C)

\*8: At 800°C and above.  
±20.0°C (< 800 to 300°C)  
±40.0°C (< 300°C)

\*9: At 0°C and above.  
±4.0°C (< 0°C)

\*10: At 0°C and above.  
±1.0°C (< 0°C)

\*11: At 0°C and above.  
±1.5°C (< 0°C)

■ **Standards for input sensors**

● **Thermocouple**

- K, E, J, T, B, R, S, N: JIS C 1602-1995
- WRe5-26: ASTM E988-96
- PR40-20: ASTM E1751-00
- Ni-NiMo: ASTM E1751-00
- PL II: ASTM E1751-00
- DIN U, DIN L: DIN 43710-1985
- Gold-iron/Chromel: ASTM E1751-00

● **RTD**

- Pt 100, JPt 100: JIS C 1604-1989

## ■ C45A Model Selection Guide

● **Choose the appropriate type of model number:**

● **Detailed Model Number**

Specifications required for a particular application can be selected in detail, allowing purchase of the optimal device (especially useful for equipment manufacturers).

● **Combined Function Model Number**

Easy selection from premade combinations of required functions. Selections have multiple I/Os, so these devices can be used flexibly for a variety of application requirements (especially useful for engineering manufacturers and factory maintenance staff).

● **Detailed Model No.** I II III IV V VI VII VIII IX X **Ex.: C45A1A1C000000**

I	II	III	IV	V	VI	VII	VIII	IX	X	Descriptions	Remarks
Basic Model	Inputs	Power	Outputs 1 and 2 <sup>*1</sup>	Outputs 3 and 4 <sup>*2</sup>	Output 5 <sup>*3</sup>	Outputs 6 and 7 <sup>*3</sup>	Options	Additional features 1	Additional features 2		
C45A										Standard model	
	1									1 full multiple input	
	2									2 full multiple inputs	
		A								AC power	
			1							Relay contact output, 1a1b	
			2							2 relay contact outputs, form 1a	
				C0						Current output (output 3)	With 2 DIs
				D0						Continuous voltage output (output 3)	With 2 DIs
				V0						Voltage pulse output (output 3)	With 2 DIs
		Available soon		V1						Voltage pulse output (output 3)	With 2 CT inputs
				RR						2 relay contact outputs, form 1a	With 2 DIs
				CC						2 current outputs	With 2 DIs
				VV						2 voltage pulse outputs	With 2 DIs
				CV						Current output (output 3) + voltage pulse output (output 4)	With 2 DIs
		Available soon		SS						Triac output + triac output	With 1 MFB input
					0					None	
					R					Relay contact output, 1a	
					C					Current output	
					D					Continuous voltage output	
					P					Transmitter Power supply	
					0					None	
						0				None	
						1				8 additional DIs	
						2				8 DOs	
						3				8 DOs + RS-485 communications	
						0				None	
						T				Tropicalization	
						K				Antisulfidization corrosion treatment	
						D				Inspection certification	
						B				Tropicalization + inspection certification	
						L				Antisulfidization corrosion treatment + inspection certification	
						0				None (standard LED colors)	
						1				All-orange LEDs	

\*1. Outputs 1 and 2 are mainly for event (alarm) output.

\*2. Outputs 3 and 4 are used mainly for control output.

\*3. Optional outputs 5-7 are used for auxiliary output or for transmitter power supply.

● **Combined Function Model No. (with all-orange LED displays)** I II III IV **Ex.: C45A000**

I	II	III	IV	Descriptions
Basic model No.	Set No.	Option 1	Option 2	
C45A				Standard model, with 2 alarm outputs
	0			(Reserved for future use)
		0		Regular type 1: Plus 1 current output, 2 relay outputs, and 2 DIs
		1		Regular type 2: Plus 1 current output, 1 voltage pulse output, 1 relay output, and 2 DIs
	Available soon	2		Position proportion type: Plus 1 relay output
		3		Regular type 3: Plus 2 current outputs, transmitter power supply (24V), and 2 DIs
	Available soon	4		Position proportion type: Plus transmitter power supply (24V)
		0		None
		1		RS-485 communications, PV input 2, 8 DOs
		2		PV input 2, 8 DOs
		3		8 DOs
		4		PV input 2

## ■ C46A Model Selection Guide

● **Choose the appropriate type of model number:**

● **Detailed Model Number**

Specifications required for a particular application can be selected in detail, allowing purchase of the optimal device (especially useful for equipment manufacturers).

● **Combined Function Model Number**

Easy selection from premade combinations of required functions. Selections have multiple I/Os, so these devices can be used flexibly for a variety of application requirements (especially useful for engineering manufacturers and factory maintenance staff).

● **Detailed Model No.** I II III IV V VI VII VIII IX X **Ex.: C46A1A1C000000**

I	II	III	IV	V	VI	VII	VIII	IX	X	Descriptions	Remarks
Basic Model	Inputs	Power	Outputs 1 and 2 <sup>*1</sup>	Outputs 3 and 4 <sup>*2</sup>	Output 5 <sup>*3</sup>	Outputs 6 and 7 <sup>*3</sup>	Options	Additional features 1	Additional features 2		
C46A										Standard model	
	1									1 full multiple input	
	2									2 full multiple inputs	
		A								AC power	
			1							Relay contact output, 1a1b	
			2							2 relay contact outputs, form 1a	
				C0						Current output (output 3)	With 2 DIs
				D0						Continuous voltage output (output 3)	With 2 DIs
				V0						Voltage pulse output (output 3)	With 2 DIs
				V1						Voltage pulse output (output 3)	With 2 CT inputs
				RR						2 relay contact outputs, form 1a	With 2 DIs
				CC						2 current outputs	With 2 DIs
				VV						2 voltage pulse outputs	With 2 DIs
				CV						Current output (output 3) + voltage pulse output (output 4)	With 2 DIs
				SS						Triac output + triac output	With 1 MFB input
					0					None	
					R					Relay contact output, 1a	
					C					Current output	
					D					Continuous voltage output	
					P					Transmitter power supply	
						0				None	
						1				Current output (output 6)	
						2				Transmitter power supply (output 7)	
						3				Current + current output <sup>*4</sup>	
						4				Current output (output 6) + transmitter power supply (output 7)	
							0			None	
							1			12 additional DIs	
							2			12 DIs + 8 DOs	
							3			12 DIs + 8 DOs + RS-485 communications	
								0		None	
								T		Tropicalization	
								K		Antisulfidization corrosion treatment	
								D		Inspection certification	
								B		Tropicalization + inspection certification	
								L		Antisulfidization corrosion treatment + inspection certification	
									0	None (standard LED colors)	
									1	All-orange LEDs	

\*1. Outputs 1 and 2 are mainly for event (alarm) output.

\*2. Outputs 3 and 4 are used mainly for control output.

\*3. Optional outputs 5-7 are used for auxiliary output or for transmitter power supply

\*4. Not available if "CC" is selected for outputs 3-4 and "C" is selected for output 5.

● **Combined Function Model No. (with all-orange LED displays)** I II III IV **Ex.: C46A000**

I	II	III	IV	Descriptions
Basic model No.	Set No.	Option 1	Option 2	
C46A				Standard model, with 1 current output and 2 alarm outputs
	0			(Reserved for future use)
		0		Regular type 1: Plus 1 current output, 2 relay outputs, and 2 DIs
		1		Regular type 2: Plus 1 current output, 1 voltage pulse output, 1 relay output, and 2 DIs
		2		Position proportion type: Plus 1 relay output
		3		Regular type 1 + additional transmitter power supply (24V)
		4		Position proportion type + additional transmitter power supply (24V)
			0	None
			1	RS-485 communications, PV input 2, 12 DIs, 8 DOs
			2	PV input 2, 12 DIs, 8 DOs
			3	2 DIs, 8 DOs
			4	PV input 2

## ■ Dimensions

(Unit: mm)

### ● C45A

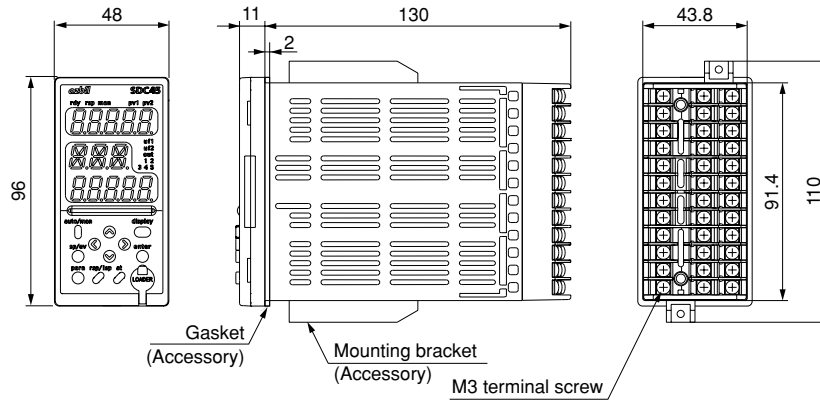

### ● C46A

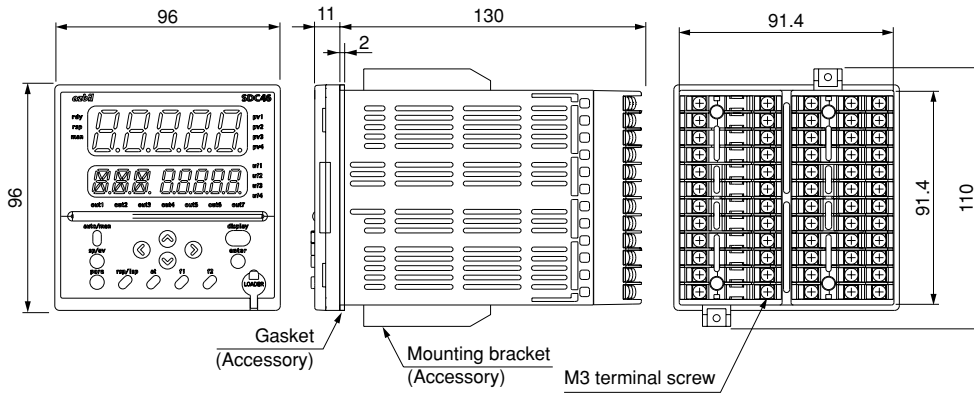

### ! Precautions in Handling

When fastening this controller onto the panel, tighten the mounting bracket screws until there is no play between the bracket and panel, and then turn one more turn. Overtightening the screws may deform the controller case.

### ● Panel cutout diagram

#### • C45A

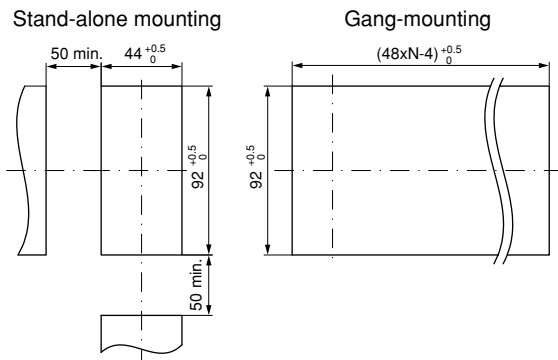

#### • C46A

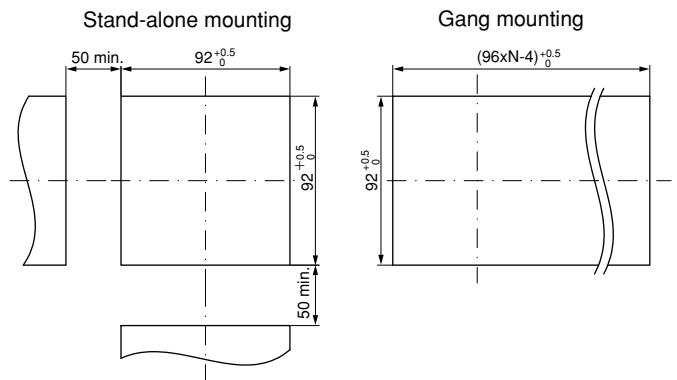

### ! Precautions in Handling

If three or more units are gang-mounted horizontally, the maximum allowable ambient temperature is 40°C.

## ■ Console Parts and Functions

### ● C45A Front Panel

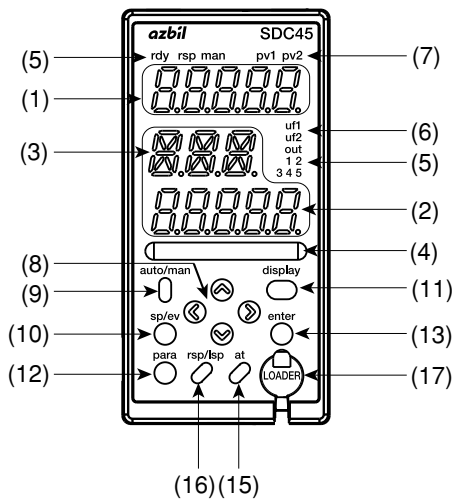

### ● C46A Front Panel

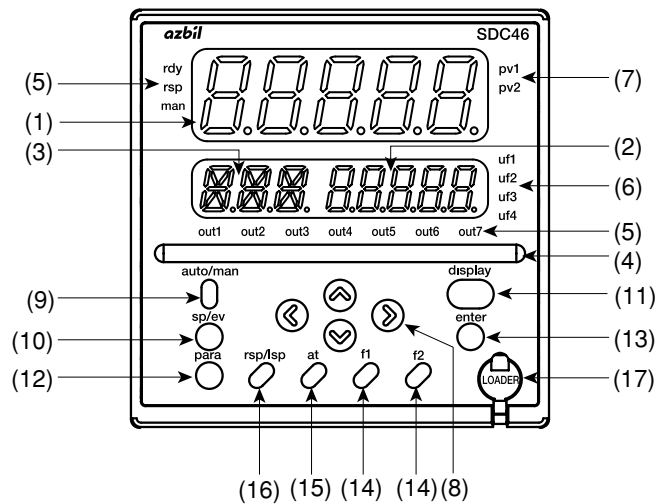

- (1) Upper display: for PV values (present temperature, etc.) or setup items.
- (2) Lower display: for SP values (set temperature, etc.) or other parameter values.
- (3) Auxiliary display: for setup items or tag names.
- (4) Multi-status (MS) indicator: for MV, DI/DO status, etc.
- (5) Mode indicator lights
  - rdy: Ready
  - rsp: Remote setup input
  - man: Manual
- out1–7: Control outputs 1–7, (1–5 for C45A)
- (6) User function indicators
  - uf1–4: Display user-assigned items, (uf1, 2 for C45A)
- (7) Loop number indicators
  - pv1, pv2: Indicate the loop number of the displayed PV value
- (8) v, ^, <, >: Increment numeric values and shift between digits or settable items.

- (9) auto/man: Changes AUTO/MANUAL mode.
- (10) sp/ev: Selects or sets LOCAL SP or EVENT.
- (11) display: Changes the display contents in operation display mode.
- (12) para: Changes the setting mode.
- (13) enter: Used during setup, especially to finalize the user's selection of a value.
- (14) f1–f2: Perform user-assigned functions (C46A only).
- (15) at: For auto-tuning executing/cancellation, or for user-assigned functions.
- (16) rsp/lsp: Changes between remote and local set point, or executes user-assigned functions.
- (17) Loader jack: For connection of PC loader cable.

# Terminal Connections

C45A Back

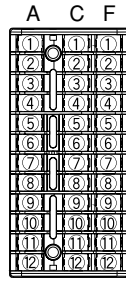

C46A Back

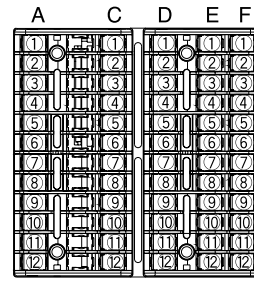

A (C45A/46A)

Details		
(1)		Power (1) AC model: 100 to 240 Vac
(1)	(2)	Outputs 1, 2 (OUT1/OUT2) (1) Relay (1a1b) (2) Relay (1a)
(1)	(3)	Output 3 (OUT3) (1) Relay (3) Current, voltage pulse, continuous voltage
(1)	(3)	Output 4 (OUT4) (1) Relay (3) Current, voltage pulse
(1)	(2)	Output 5 (OUT5) (1) Relay (2) Current, continuous voltage, transmitter power supply

C (C45A)

Details		
(1)	(2)	Digital input/output (DI/DO) (1) DI (2) DO
DA ↔ 10		RS-485 communications
DB ↔ 11		
SG → 12		

C (C46A)

Details		
		Digital input (DI)
		Output 6 (OUT6) Current
		Output 7 (OUT7) Current Transmitter power supply
DA ↔ 10		RS-485 communications
DB ↔ 11		
SG → 12		

D (C46A)

Details		
		Digital input (DI)
10 —		Unused
11 —		
12 —		

E (C46A)

Details		
		Digital output (DO)
10 —		Unused
11 —		
12 —		

F (C45A/46A)

Details		
(1)		Other (1) Digital input (DI)
4 —		Unused
(1)	(2)	(4)
		PV input 2 (PV2) (1) Thermocouple (2) RTD (3-wire) (4) DC voltage/current
(1)	(2)	(4)
		PV input 1 (PV1) (1) Thermocouple (2) RTD (3-wire) (4) DC voltage/current



## RESTRICTIONS ON USE

This product has been designed, developed and manufactured for general-purpose application in machinery and equipment. Accordingly, when used in the applications outlined below, special care should be taken to implement a fail-safe and/or redundant design concept as well as a periodic maintenance program.

- Safety devices for plant worker protection
- Start/stop control devices for transportation and material handling machines
- Aeronautical/aerospace machines
- Control devices for nuclear reactors

Never use this product in applications where human safety may be put at risk.

*Specifications are subject to change without notice.*

**azbil**

### **Yamatake Corporation Advanced Automation Company**

1-12-2 Kawana, Fujisawa  
Kanagawa 251-8522 Japan  
URL: <http://www.azbil.com>

Printed in Japan. (H)  
1st Edition: Issued in May, 2007

Printed on recycled paper.

(07)