

# Single Loop Controller SDC35/36

## ■ Features

The DigitroniK SDC35/36 is a digital indicating controller featuring multi-range inputs and PID control system using new algorithms "RationalLOOP" and "Just-FiTTER". Up to two control output points (this number of points may vary depending on the model) can be used, which are selectable from the relay contact, voltage pulse, continuous voltage, and current.

The smart loader package ensures easy setting operation and monitoring.

This controller is compliant to the IEC directives and the CE marking.

- Space saving design with a depth of 65mm.  
The mask of the front panel is also only 5mm thick.
- High accuracy of  $\pm 0.1\%$ FS and sampling cycle of 0.1s (seconds).
- Multi-range inputs are available for selection, where the input type can be freely changed among thermocouple, RTD, current, and voltage.
- The control method can be selected from any of the ON/OFF control and PID control using "RationalLOOP" + "Just-FiTTER".



- The heat/cool control can be achieved using two control output points and event outputs.
- The RS-485 communication function is provided as an optional function.
- The control output types available for selection are relay, voltage pulse, current, and continuous voltage outputs which can be combined.
- Event 3 points or 2 points (independent contact), CT input 2 points, DI 4 points, and RSP inputs, RS-485 can be selected in combination.
- The smart loader package (SLP-C35) can be used.

## ■ Basic Function Block of SDC35/36

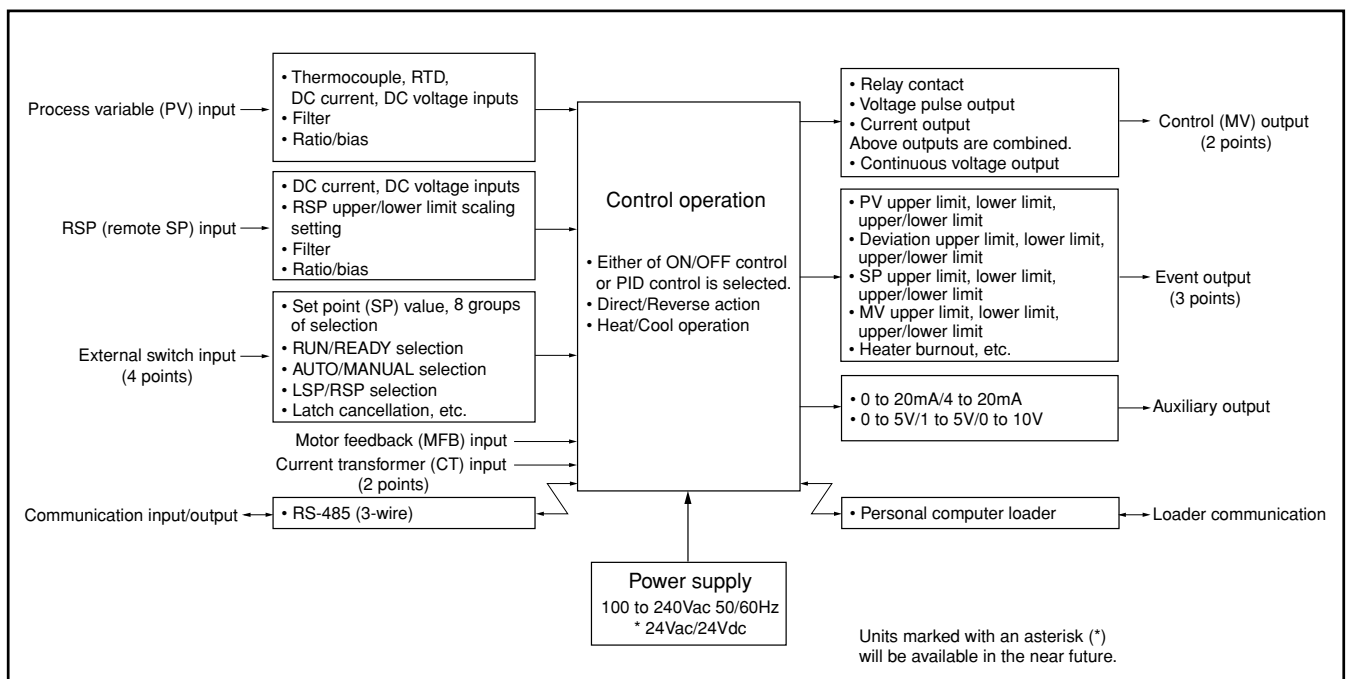

## ■ Specifications

<b>PV input</b>	Input type	Multi-range of inputs - thermocouple, RTD, DC current and DC voltage					
	Input sampling time	0.1s					
	Input bias	-1999 to +9999 digit					
	Input bias current	Thermocouple input:	0.2μA or less	(Note 1) RTD or A-wire burnout: Upscale + AL01 B-wire or C-wire burnout: Upscale + AL01, 03 More than 2-wire burnout: Upscale + AL01, 03			
		RTD input:	1mA typical				
	DC voltage input:	1V range or less... 1μA or less 0 to 5V, 1 to 5V range... 3.5μA or less 0 to 10V range... 7μA or less					
Burnout	Thermocouple input:	Upscale + alarm display					
	RTD input:	Upscale + alarm display (Note 1)					
	DC voltage input:	Upscale + alarm display (However, the burnout cannot be detected for the 0 to 10V range.)					
	DC current input:	Upscale + alarm display (However, the burnout cannot be detected for the 0 to 20mA range.)					
<b>Indications and setting</b>	PV, SP indication method	4-digit, 7-segment LED (PV: Upper green display, SP: Lower orange display)					
	Number of setting points	Max. 8 points					
	Setting range	Lower to higher limit value of the PV range (Restriction by SP lower limit to upper limit possible)					
	Multi-status indicator	The control output status, alarm or RUN/READY status is indicated.					
	Indication accuracy	±0.1%FS±1 digit In the negative area of the thermocouple, the accuracy is ±0.2%FS±1 digit (at an ambient temperature of 23±2°C.)					
	Indication range	See Table 1.					
<b>Control output</b>	Output type	<b>Relay contact</b>	<b>Motor drive relay output</b>	<b>Voltage pulse output</b>	<b>Current output</b>	<b>Continuous voltage output</b>	
	Control action	Time proportional PID	Position proportional PID	Time proportional PID	Continuous PID	Continuous PID	
	Number of PID groups	Max. 8 groups					
	PID auto-tuning	Automatic PID value setting by limit cycle method. However, one of the following 3 control characteristics can be selected: • Standard • Quick disturbance response • Less up/down fluctuations					
	Output rating	Control output: 1 NO side: 250Vac/30Vdc, 3A (resistive load) Control output: 2 NC side: 250Vac/30Vdc, 1A (resistive load) Service life: NO side: 50,000 cycles or more NC side: 100,000 cycles or more Min. opening/closing time: 250ms	Contact type: 1c 2-circuit Contact rating: 250Vac 8A (resistive load) Service life: 120,000 cycles or more Min. switching specifications: 24Vdc, 40mA	Open terminal voltage: 19Vdc ± 15% Internal resistance: 82Ω ± 0.5% Allowable current: Max. 24mA Min. OFF/ON time: When 10s or less: 1ms When 10s or longer: 250ms	Output type: 0 to 20mA or 4 to 20mA Allowable load resistance: Max. 600Ω Output accuracy: ±0.1%FS (However, ±1%FS for 0 to 1mA) Output resolution: 1/10000	Output type: 0 to 5Vdc/ 1 to 5Vdc or 0 to 10Vdc Allowable load resistance: Min. 1000Ω Output accuracy: ±0.1%FS (However, ±1%FS for 0 to 0.05V) Output resolution: 1/10000	
	Cycle time (s)	5 to 120	—	0.1, 0.25, 0.5, 1 to 20	—	—	
	PID control	Proportional band (%FS)		0.1 to 999.9			
		Integral time (s)		0 to 9999 or 0.0 to 999.9			
		Derivative time (s)		0 to 9999 or 0.0 to 999.9			
		Manual set (%)		-10.0 to +110.0			
	Just-FITTER	Overshoot suppression coefficient		0 to 100			
	ON/OFF control	Operating differential (°C)		0 to 9999 or 0.0 to 999.9			
	Control operation selection	Direct action or reverse action					
	Heat/Cool control selection	Control output and event output (When the control output is a motor drive relay output, the heat/cool control is disabled.)					
	<b>Auxiliary output</b>		<b>Current output</b>			<b>Continuous voltage output</b>	
		Output type	0 to 20mA or 4 to 20mA			0 to 5Vdc/1 to 5Vdc or 0 to 10Vdc	
		Load resistance	Max. 600Ω			Min. 1000Ω	
Output accuracy		±0.1%FS (However, ±1%FS for 0 to 1mA)			±0.1%FS (However, ±1%FS for 0 to 0.05V)		
Output resolution		1/10000			1/10000		
<b>External contact input (DI)</b>	Number of inputs	Max. 4 points					
	Function	Up to 8 kinds of setting value (SP) selections, PID group selection, RUN/READY selection, AUTO/MANUAL selection, LSP/RSP selection, Auto tuning stop/start, Control action Direct/Reverse selection, SP ramp enable/disable, PV value hold, Max. PV value hold, Min. PV value hold, Timer start/stop, All DO latch cancellation, advance operation, step hold					
	Input rating	Non-voltage contact or open collector					
	Min. detection holding time	0.2s or longer					
	Allowable ON contact resistance	Max. 250Ω					
	Allowable OFF contact resistance	Min. 100kΩ					
	Allowable ON-state residual voltage	Max. 1.0V					
	Open terminal voltage	5.5Vdc±1V					
	ON terminal current	Approx. 7.5mA (at short-circuit), Approx. 5.0mA (at contact resistance of 250Ω)					

<b>Event</b>	Number of output points	2 to 3 points (according to a model)			
	Number of internal event settings	Up to 8 settings			
<b>Event type</b> <ul style="list-style-type: none"> <li>● shows that the ON/OFF is changed at this value.</li> <li>○ shows that the ON/OFF is changed at a point that "1U" is added to this value.</li> </ul>	<b>PV high limit</b>		<b>PV low limit</b>		
	<b>Direct action</b>	<b>Reverse action</b>	<b>Direct action</b>	<b>Reverse action</b>	
	<b>PV high/low limit</b>		<b>Deviation high limit</b>		
	<b>Direct action</b>	<b>Reverse action</b>	<b>Direct action</b>	<b>Reverse action</b>	
	<b>Deviation low limit</b>		<b>Deviation high/low limit</b>		
	<b>Direct action</b>	<b>Reverse action</b>	<b>Direct action</b>	<b>Reverse action</b>	
	<b>SP high limit</b>		<b>SP low limit</b>		
	<b>Direct action</b>	<b>Reverse action</b>	<b>Direct action</b>	<b>Reverse action</b>	
	<b>SP high/low limit</b>		<b>MV high limit</b>		
	<b>Direct action</b>	<b>Reverse action</b>	<b>Direct action</b>	<b>Reverse action</b>	
	<b>MV low limit</b>		<b>MV high/low limit</b>		
	<b>Direct action</b>	<b>Reverse action</b>	<b>Direct action</b>	<b>Reverse action</b>	
	<b>Heater burnout/Over-current</b>		<b>Heater short-circuit</b>		
	<b>Direct action</b>	<b>Reverse action</b>	<b>Direct action</b>	<b>Reverse action</b>	

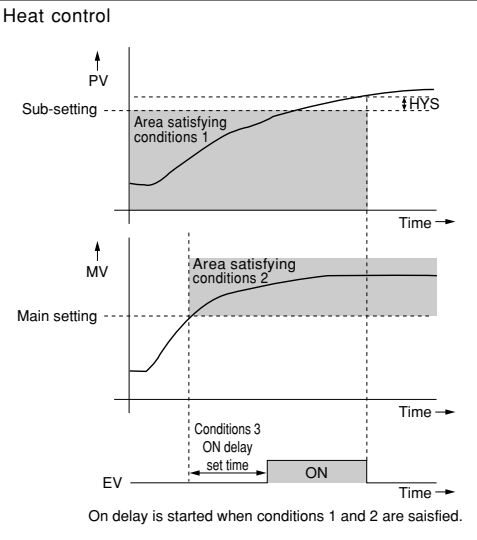
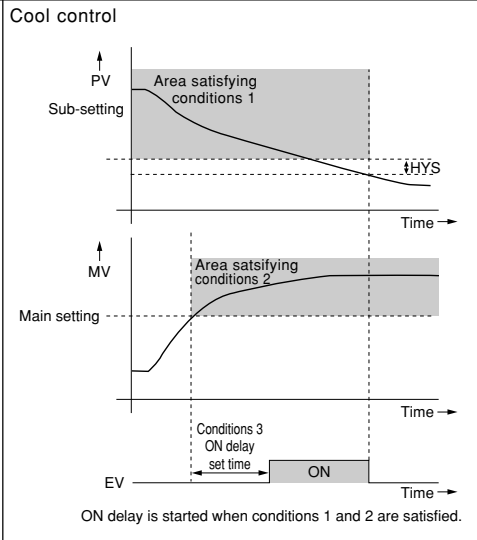
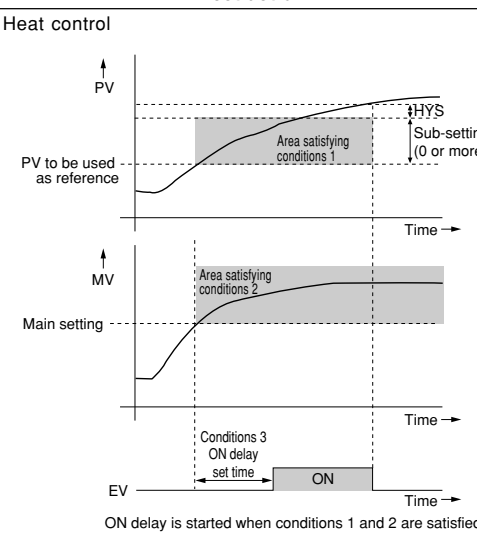
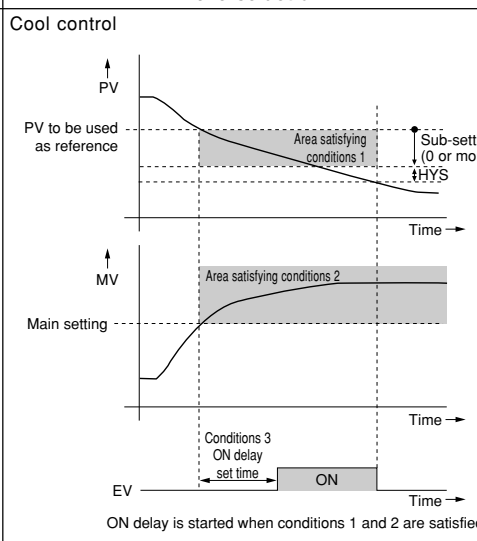
<b>Event</b>	<b>Event type</b> <ul style="list-style-type: none"> <li>● shows that the ON/OFF is changed at this value.</li> <li>○ shows that the ON/OFF is changed at a point that "1U" is added to this value.</li> </ul>	<b>Loop diagnosis 1</b>		
	<p>The event is turned ON when any change in PV corresponding to increase/decrease in MV (Manipulated variable) is not observed.  This event is used to detect any fault of final control devices.</p> <ul style="list-style-type: none"> <li>● <b>Setting items</b> <ul style="list-style-type: none"> <li>• Main setting: MV (Manipulated variable)</li> <li>• Sub-setting: PV</li> <li>• ON delay time: Diagnosis time</li> </ul> </li> <li>● <b>Operation specifications</b>  The event is turned ON when the value does not reach the PV set in the sub-setting within the diagnosis time (ON delay time) even though the MV exceeding the main setting is held.</li> <li>● <b>CAUTION</b>  When setting the ON delay, it is necessary to put in "Multi-function setup".  The default setting of the ON delay before shipment is 0.0s.</li> </ul>			
	<b>Direct action</b>		<b>Reverse action</b>	
	<b>Heat control</b>  <p>On delay is started when conditions 1 and 2 are satisfied.</p>		<b>Cool control</b>  <p>ON delay is started when conditions 1 and 2 are satisfied.</p>	
<b>Loop diagnosis 2</b>				
<p>The event is turned ON when any change in PV corresponding to increase/decrease in MV (Manipulated variable) is not observed.  This event is used to detect any fault of final control devices.</p> <ul style="list-style-type: none"> <li>● <b>Setting items</b> <ul style="list-style-type: none"> <li>• Main setting: MV (Manipulated variable)</li> <li>• Sub-setting: Change in PV from the point that the MV exceeds the main setting.</li> <li>• ON delay time: Diagnosis time</li> </ul> </li> <li>● <b>Operation specifications</b>  The event is turned ON when the MV exceeding the main setting is held (conditions 2) and the PV does not reach the value that the sub-setting is added to (subtracted from) the PV at the point where the MV exceeds the main setting within the diagnosis time (ON delay time) (conditions 1).</li> <li>● <b>CAUTION</b>  When setting the ON delay, it is necessary to put in "Multi-function setup".  The default setting of the ON delay before shipment is 0.0s.</li> </ul>				
<b>Direct action</b>		<b>Reverse action</b>		
<b>Heat control</b>  <p>ON delay is started when conditions 1 and 2 are satisfied.</p>		<b>Cool control</b>  <p>ON delay is started when conditions 1 and 2 are satisfied.</p>		

<b>Event</b>	<b>Event type</b> <ul style="list-style-type: none"> <li>● shows that the ON/OFF is changed at this value.</li> <li>○ shows that the ON/OFF is changed at a point that "1U" is added to this value.</li> </ul>	<b>Loop diagnosis 3</b>		
	<p>The event is turned ON when any change in PV corresponding to increase/decrease in MV (Manipulated variable) is not observed. This event is used to detect any fault of final control devices.</p> <ul style="list-style-type: none"> <li>● <b>Setting items</b> <ul style="list-style-type: none"> <li>• Main setting: Change in PV from the point that the MV reaches the upper limit (100%) or lower limit (0%).</li> <li>• Sub-setting: Range of absolute value of deviation (PV – SP) allowing the event to turn OFF.</li> <li>• ON delay time: Diagnosis time</li> <li>• OFF delay time: A period of time from power ON allowing the event to turn OFF.</li> </ul> </li> <li>● <b>Operation specifications</b> <ul style="list-style-type: none"> <li>• The direct action is used for the heat control. The event is turned ON when the increase in PV becomes smaller than the main setting after the diagnosis time (ON delay time) has elapsed from the time that the MV had reached the upper limit, or when the decrease in PV becomes smaller than the main setting from the time that the diagnosis time (ON delay time) has elapsed from the time that the MV had reached the lower limit.</li> <li>• The reverse action is used for the cool control. The event is turned ON when the decrease in PV becomes smaller than the main setting after the diagnosis time (ON delay time) has elapsed from the time that the MV had reached the upper limit, or when the increase in PV becomes smaller than the main setting after the diagnosis time (ON delay time) has elapsed from the time that the MV had reached the lower limit.</li> <li>• The event is turned OFF regardless of other conditions when the absolute value of the deviation (PV – SP) becomes less than the sub-setting.</li> <li>• The event is turned OFF regardless of other conditions when a period of time after starting of operation from the time that the power has been turned ON becomes less than the OFF delay time. However, the event is turned OFF when the absolute value of the deviation is the (sub-setting – hysteresis) value or less after the absolute value of the deviation has become the sub-setting or more.</li> </ul> </li> <li>● <b>CAUTION</b> When setting the ON delay and OFF delay, it is necessary to put in "Multi-function setup". The default settings of the ON delay and OFF delay before shipment are 0.0s.</li> </ul>			
	<b>Direct action</b>		<b>Reverse action</b>	
	Heat control		Cool control	
	ON delay is started when conditions 1 and 2 are satisfied.		ON delay is started when conditions 1 and 2 are satisfied.	
	<b>PV alarm (status)</b>			
	<b>Direct action</b>		<b>Reverse action</b>	
	ON if PV alarm (alarm code AL01 to 03) occurs, OFF in other cases.		OFF if PV alarm (alarm code AL01 to 03) occurs, ON in other cases.	
	<b>READY (status)</b>			
	<b>Direct action</b>		<b>Reverse action</b>	
	ON in the READY mode. OFF in the RUN mode.		OFF in the READY mode. ON in the RUN mode.	
	<b>MANUAL (status)</b>			
	<b>Direct action</b>		<b>Reverse action</b>	
	ON in the MANUAL mode. OFF in the AUTO mode.		OFF in the MANUAL mode. ON in RUN mode.	
	<b>During AT (Auto tuning)</b>			
	<b>Direct action</b>		<b>Reverse action</b>	
	ON while AT is running. OFF while AT is being stopped.		OFF while AT is running. ON while AT is being stopped.	
	<b>During SP ramp</b>			
	<b>Direct action</b>		<b>Reverse action</b>	
ON during SP ramp. OFF when SP ramp is not performed or is completed.		OFF during SP ramp. ON when SP ramp is not performed or is completed.		
<b>Control operation (status)</b>				
<b>Direct action</b>		<b>Reverse action</b>		
ON during direct action (cooling). OFF during reverse action (heating).		OFF during direct action (cooling). ON during reverse action (heating).		
<b>During motor opening estimation (status)</b>				
<b>Direct action</b>		<b>Reverse action</b>		
ON during estimated position control. OFF in other cases.		OFF during estimated position control. ON in other cases.		

<b>Event</b>	<b>Event type</b>	<p>● shows that the ON/OFF is changed at this value.</p> <p>○ shows that the ON/OFF is changed at a point that "1U" is added to this value.</p>		
		<p style="text-align: center;"><b>Timer (status)</b></p> <p>The direct and reverse action settings are disabled for the timer event. When using the timer event, it is necessary to set the operation type of the DI allocation to "Timer Start/Stop". Additionally, when setting the event channel designation of the DI allocation, multiple timer events are controlled from individual internal contacts (DI).</p> <ul style="list-style-type: none"> <li>● Setting items <ul style="list-style-type: none"> <li>• ON delay time: A period of time necessary to change the event from OFF to ON after DI has been changed from OFF to ON.</li> <li>• OFF delay time: A period of time necessary to change the event from ON to OFF after DI has been changed from ON to OFF.</li> </ul> </li> <li>● Operation specifications <ul style="list-style-type: none"> <li>• The event is turned ON when DI ON continues for ON delay time or longer.</li> <li>• The event is turned OFF when DI OFF continues for OFF delay time or longer.</li> <li>• In other cases, the current status is continued.</li> </ul> </li> </ul>		
		<ul style="list-style-type: none"> <li>● CAUTION</li> </ul> <p>When setting the ON delay and OFF delay, it is necessary to put in "Multi-function setup". The default settings of the ON delay and OFF delay before shipment are 0.0s. The default setting of the event channel designation of the DI allocation before shipment is "0". In this case, the timer event start/stop can be set for all internal events from one internal contact (DI). Additionally, as one or more event channel designation is set, the timer event start/stop can be set for one internal event specified by one internal contact (DI). However, when setting the event channel of the DI allocation, it is necessary to put in "Multi-function setup".</p>		
		<p>Direct/Reverse action, standby, and READY operations can be set when setting up each event (E1.C1 to E5.C2).</p>		
		<b>RSP (status)</b>		
		<b>Direct action</b>	<b>Reverse action</b>	
		ON in RSP mode. OFF in LSP mode.	OFF in RSP mode. ON in LSP mode.	
		Operating differential	0 to 9999 digit	
		Output operation	ON/OFF operation	
	Output type	SPST relay contacts, Common for 3 points/independent contact for 2 points		
	Output rating	250Vac/30Vdc, 2A (resistive load)		
	Life	100,000 cycles or more		
	Min. opening and closing specifications	5V, 10mA (reference value)		
<b>Communication</b>	Communication system	Communication protocol	RS-485	
		Network	Multidrop, This device is provided with the slave station function. 1 to 31 units max.	
		Data flow	Half-duplex	
		Synchronization method	Start/stop synchronization	
	Interface	Transmission system	Balance (differential) type	
		Data line	Bit serial	
		Communication lines	3 transmit/receive lines	
		Transmission speed	4800, 9600, 19200, 38400 bps	
		Communication distance	500m max.	
		Protocol	RS-485 (3-wire type)	
Message characters	Character configuration	9 to 12 bits/character		
	Data length	7 or 8 bits		
	Stop bit length	1 or 2 bits		
	Parity bit	Even parity, odd parity, or non-parity		
<b>Loader communication</b>	Communication line	3-wire		
	Transmission speed	Fixed at 19200 bps		
	Recommended cable	Dedicated cable, 2m long		
<b>Current transformer input</b>	Number of inputs	2 points		
	Detection function	Control output is ON.: Detection of heater line break or overcurrent Control output is OFF.: Detection of final control devices short-circuit		
	Input object	Number of current transformer windings: 800 turns QN206A (5.8mm-hole diameter)      Optional QN212A (12mm-hole diameter)      Optional		
	Measurement current range	0.4 to 50A		
	Indication accuracy	±5%FS±1 digit		
	Indication range	0.0 to 70.0A		
	Indication resolution	0.1A		
	Output	Selected from control output 1 and control output 2, or event output 1, event output 2, and event output 3.		
	Min. detection time	Burnout detection: Min. control output ON time 0.3s or more Final control device short-circuit detection: Min. control output OFF time 0.3s or more		

<b>General specifications</b>	Memory backup	Semiconductor non-volatile memory					
	Power supply voltage	AC power supply model: 85 to 264Vac, 50/60Hz±2Hz					
	Power consumption	AC power supply model: Max. 12VA					
	Insulation resistance	Between power supply terminal and secondary terminal, 500Vdc, 10MΩ or more					
	Dielectric strength	AC power supply model: Between power supply terminal and secondary terminal, 1500Vac for 1 min.					
	Power ON inrush current	AC power supply model: 20A or less					
	Operating conditions	Ambient temperature	0 to 50°C (0 to 40°C for side-by-side mounting)				
		Ambient humidity	10 to 90%RH (No condensation allowed)				
		Vibration resistance	0 to 2m/s <sup>2</sup> (10 to 60Hz for 2 hrs. in each of X, Y, and Z directions)				
		Shock resistance	0 to 10m/s <sup>2</sup>				
		Mounting angle	Reference plane ±10°				
	Transportation conditions	Ambient temperature	-20 to +70°C				
		Ambient humidity	10 to 95%RH (No condensation allowed)				
		Package drop test	Drop height, 60cm, (1 corner, 3 sides, 6 planes, free fall)				
	Console and case material	Console: Polyester film Case: Modified PPE					
	Case color	Light gray (DIC650)					
Conformed standards	EN61010-1, EN61326-1						
Overvoltage category	Category II (IEC60364-4-433, IEC644-1)						
Mounting	Panel mounting (with dedicated mounting bracket)						
Weight	SDC35: Approx. 250g (including dedicated mounting bracket) SDC36: Approx. 300g (including dedicated mounting bracket)						
<b>Standard accessories</b>	<b>Part name</b>	<b>Model</b>	<b>Q'ty</b>	<b>Optional parts (sold separately)</b>	<b>Part name</b>	<b>Model</b>	<b>Q'ty</b>
	Mounting bracket	<b>81409654-001</b>	1		Mounting bracket	<b>81409654-001</b>	1
	User's manual	<b>CP-UM-5289E</b>	1		Current transformer	<b>QN206A</b> (5.8mm-hole dia.)	1
						<b>QN216A</b> (12mm-hole dia.)	1
					Hard cover	<b>81446915-001</b> (for SDC35)	1
						<b>81446916-001</b> (for SDC36)	1
					Terminal cover	<b>81446912-001</b> (for SDC35)	1
						<b>81446913-001</b> (for SDC36)	1
					Smart loader package	<b>SLP-C35J50</b> (common for SDC35 and SDC36)	1

**Table 1 Input Types and Ranges**

Input type	C01 No.	Sensor type	Range	
Thermo-couple	1	K	-200 to +1200°C	-300 to +2200°F
	2	K	0 to 1200°C	0 to 2200°F
	3	K	0 to 800°C	0 to 1500°F
	4	K	0.0 to 600.0°C	0 to 1100°F
	5	K	0.0 to 400.0°C	0 to 700°F
	6	K	-200.0 to +400.0°C	-300 to +700°F
	7	K	-200.0 to +200.0°C	-300 to +400°F
	8	J	0 to 1200°C	0 to 2200°F
	9	J	0.0 to 800.0°C	0 to 1500°F
	10	J	0.0 to 600.0°C	0 to 1100°F
	11	J	-200.0 to +400.0°C	-300 to +700°F
	12	E	0.0 to 800.0°C	0 to 1500°F
	13	E	0.0 to 600.0°C	0 to 1100°F
	14	T	-200.0 to +400.0°C	-300 to +700°F
	15	R	0 to 1600°C	0 to 3000°F
	16	S	0 to 1600°C	0 to 3000°F
	17	B	0 to 1800°C	0 to 3300°F
	18	N	0 to 1300°C	0 to 2300°F
	19	PL II	0 to 1300°C	0 to 2300°F
	20	Wre5-26	0 to 1400°C	0 to 2400°F
	21	Wre5-26	0 to 2300°C	0 to 4200°F
	22	Ni-NiMo	0 to 1300°C	0 to 2300°F
	23	PR40-20	0 to 1900°C	0 to 3400°F
	24	DIN U	-200.0 to +400.0°C	-300 to +700°F
	25	DIN L	-100.0 to +800.0°C	-150 to +1500°F
	26	Golden iron chromel	0.0K to 360.0°K	0.0 to 360.0°K

**! Handling Precautions**

- The accuracy is  $\pm 0.1\%FS \pm 1$  digit, and  $\pm 0.2\%FS \pm 1$  digit for a negative area of the thermocouple.
- The accuracy varies according to the range.  
 The accuracy of the No.15 (sensor type R) or No. 16 (sensor type S) is  $\pm 0.2\%FS$  for a range of 100°C or less, and  $\pm 0.15\%FS$  for 100 to 1600°C.  
 The accuracy of the No.17 (sensor type B) is  $\pm 4.0\%FS$  for a range of 260°C or less,  $\pm 0.4\%FS$  for 260 to 800°C and  $\pm 0.2\%FS$  for 800 to 1800°C.  
 The accuracy of the No.23 (sensor type PR40-20) is  $\pm 2.5\%FS$  for 0 to 300°C,  $\pm 1.5\%FS$  for 300 to 800°C,  $\pm 0.5\%FS$  for 800 to 1900°C.  
 The accuracy of the No.26 (sensor type golden iron chromel) is  $\pm 1.5K$ .  
 The accuracy of the No. 55 to 62 and 81 is  $\pm 0.15\%FS$  for each range.
- For ranges with a decimal point, tenths are displayed on the line underneath the point.

Input type	C01 No.	Sensor type	Range	
RTD	41	Pt100	-200.0 to +500.0°C	-300 to +900°F
	42	JPt100	-200.0 to +500.0°C	-300 to +900°F
	43	Pt100	-200.0 to +200.0°C	-300 to +400°F
	44	JPt100	-200.0 to +200.0°C	-300 to +400°F
	45	Pt100	-100.0 to +300.0°C	-150 to +500°F
	46	JPt100	-100.0 to +300.0°C	-150 to +500°F
	47	Pt100	-100.0 to +200.0°C	-150 to +400°F
	48	JPt100	-100.0 to +200.0°C	-150 to +400°F
	49	Pt100	-100.0 to +150.0°C	-150 to +300°F
	50	JPt100	-100.0 to +150.0°C	-150 to +300°F
	51	Pt100	-50.0 to +200.0°C	-50 to +400°F
	52	JPt100	-50.0 to +200.0°C	-50 to +400°F
	53	Pt100	-50.0 to +100.0°C	-50 to +200°F
	54	JPt100	-50.0 to +100.0°C	-50 to +200°F
	55	Pt100	-60.0 to +40.0°C	-60 to +100°F
	56	JPt100	-60.0 to +40.0°C	-60 to +100°F
	57	Pt100	-40.0 to +60.0°C	-40 to +140°F
	58	JPt100	-40.0 to +60.0°C	-40 to +140°F
	59	Pt100	-10.00 to +60.00°C	-10 to +140°F
	60	JPt100	-10.00 to +60.00°C	-10 to +140°F
	61	Pt100	0.0 to 100.0°C	0 to 200°F
	62	JPt100	0.0 to 100.0°C	0 to 200°F
	63	Pt100	0.0 to 200.0°C	0 to 400°F
	64	JPt100	0.0 to 200.0°C	0 to 400°F
	65	Pt100	0.0 to 300.0°C	0 to 500°F
	66	JPt100	0.0 to 300.0°C	0 to 500°F
	67	Pt100	0.0 to 500.0°C	0 to 900°F
	68	JPt100	0.0 to 500.0°C	0 to 900°F

Input type	C01 No.	Sensor type	Range
Linear input	81	0 to 10mV	Scaling in the range of -1999 to +9999 Decimal point position changeable
	82	10 to +10mV	
	83	0 to 100mV	
	84	0 to 1V	
	86	1 to 5V	
	87	0 to 5V	
	88	0 to 10V	
	89	0 to 20mA	
	90	4 to 20mA	

## Model Selection Guide

I II III IV V VI VII VIII Example: C35TR0UA1000

I	II	III	IV	V	VI	VII	VIII	Specifications		Remarks
Basic model No.	Mounting	Control output	PV input	Power supply	Option 1	Option 2	Additional processing			
C35								Mask size 48mm x 96mm		
C36								Mask size 96mm x 96mm		
	T							Panel mounting type		
								<b>Control output 1</b>	<b>Control output 2</b>	
		R0						Relay contact output	—	
		R1						Relay contact output for motor drive	—	With MFB
		V0						Voltage pulse output (for SSR drive)	—	
		VC						Voltage pulse output (for SSR drive)	Current output	
		VD						Voltage pulse output (for SSR drive)	Continuous voltage output	
		VV						Voltage pulse output (for SSR drive)	Voltage pulse output (for SSR drive)	
		C0						Current output	—	
		CC						Current output	Current output	
		CD						Current output	Continuous voltage output	
		D0						Continuous voltage output	—	
		DD						Continuous voltage output	Continuous voltage output	
			U					Universal		
				A				AC model (100 to 240Vac) 50/60Hz		
					D			DC model (24Vac/dc) (available soon)		
						1		Event relay output: 3 points		
						2		Event relay output: 3 points, Auxiliary output (current output)		
						3		Event relay output: 3 points, Auxiliary output (voltage output)		
				(Note 3)		4		Event relay output: 2 points (independent contact)		
				(Note 3)		5		Event relay output: 2 points (independent contact), Auxiliary output (current output)		
				(Note 3)		6		Event relay output: 2 points (independent contact), Auxiliary output (voltage output)		
						0		—		
				(Note 1, 2)		1		Current transformer inputs: 2 points, Digital inputs: 4 points		
				(Note 1, 2)		2		Current transformer inputs: 2 points, Digital inputs: 4 points, RS-485 communication		
				(Note 1, 2)		3		Current transformer inputs: 2 points, Digital inputs: 2 points, RSP input		
				(Note 1, 2)		4		Current transformer inputs: 2 points, Digital inputs: 2 points, RSP input, RS-485 communication		
						00		No additional processing		
						D0		Inspection Certificate provided		
						Y0		Complying with the traceability certification		

Note 1. A current transformer is sold separately.

Note 2. When the control output is R1, the current transformer input is not applied. MFB input is applied.

Note 3. Can not be selected for DC model.

## ■ Dimensions

### ● C35

(Unit: mm)

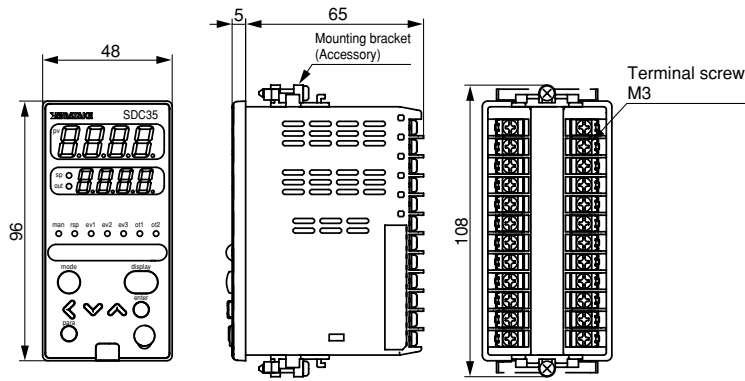

### ● C36

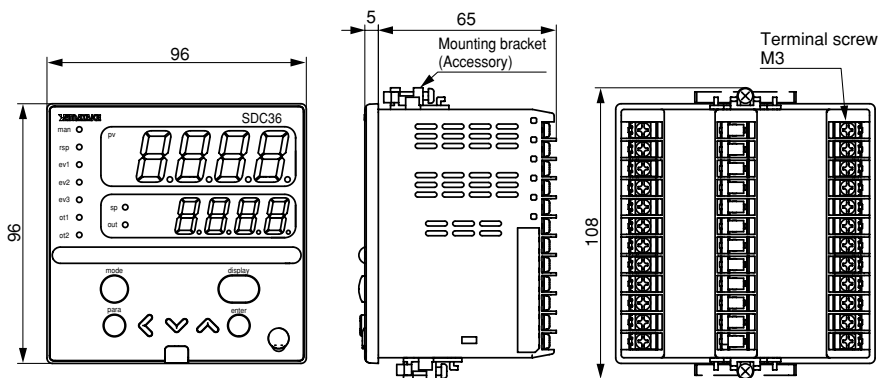

### ! Handling Precautions

To fasten this controller onto the panel, tighten a mounting bracket screws, and turn one more half turn when there is no play between the bracket and panel. Excessively tightening the screws may deform the controller case.

## ● Panel cutout diagram

### ● C35

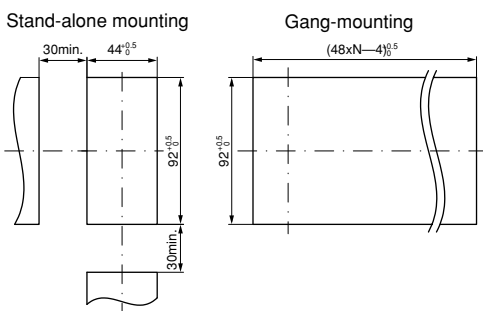

### ● C36

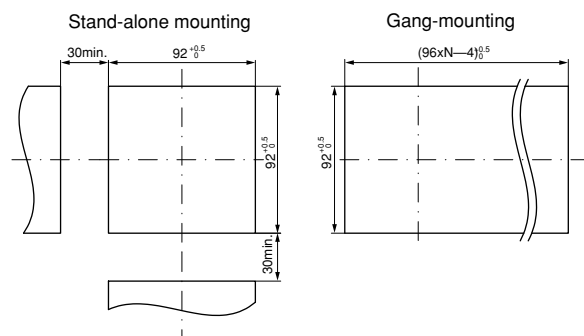

### ! Handling Precautions

- When three or more units are gang-mounted horizontally, the maximum allowable ambient temperature is 40°C.

## Part Names and Functions

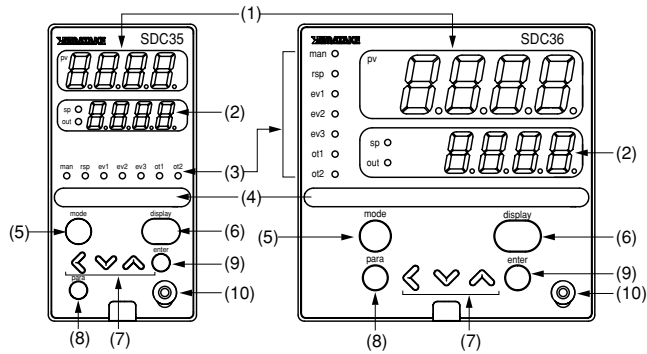

- (1) Upper display: Displays PV values (present temperature, etc.) or setup items.
- (2) Lower display: Displays SP values (set temperature, etc.) and other parameter values. When the lower display shows the SP value, the "sp" lamp lights up. When the display shows the manipulated variable (MV), the "out" lamp lights up.

### (3) Mode indicator

- man: Lights when MANUAL (manual mode).  
 rsp: Lights when RSP mode (remote setup input).  
 ev1 to ev3: Lights when event relays are ON.  
 ot1, ot2: Lights when the control output is ON.

### (4) Multi-status indicator:

In the combination of the lighting condition and the lighting status as a group, the priority 3 groups can be set.

### (5) [mode] key:

The operation which has been set beforehand can be done by pushing the key for 1s or more.

### (6) [display] key:

Used to change the display contents in the operation display mode. Display is returned from bank setup display to operation display.

### (7) <math>\lt; ></math>, <math>\vee </math>, <math>\wedge </math> key:

Used for incrementing numeric values and performing arithmetic shift operations.

### (8) [para] key:

Switches the display.

### (9) [enter] keys:

Used to set the setup values at the start of change and during the change.

### (10) Loader connector: Connects to a personal computer by using a dedicated cable supplied with the Smart Loader Package.

## Connection of C35/36

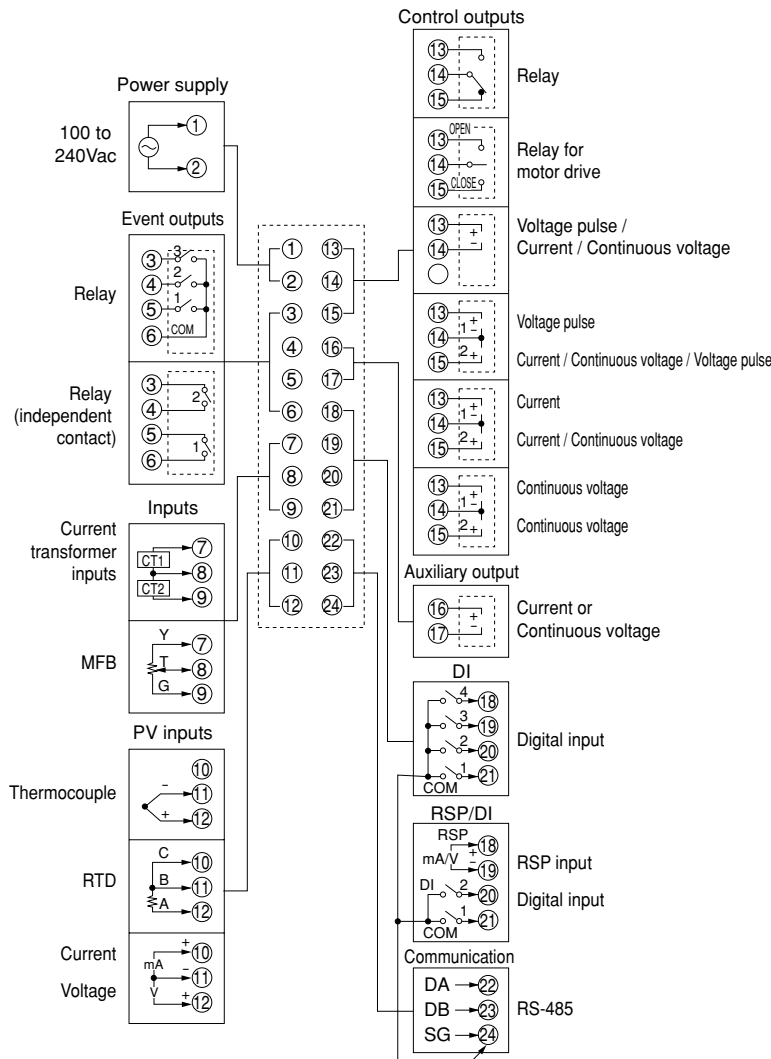

● **Precautions on the use of self-tuning function**

The final control devices must be powered up simultaneously with or prior to the instrument when the self-tuning function is to be used.

● **Precautions on wiring**

**1. Isolation within instrument**

Solid line portions " — " are isolated.  
Dotted line portions " - - - " are not isolated.

Power supply	Internal Circuit	Control output 1
PV input		Control output 2
CT input 1		Auxiliary output
CT input 2		
MFB input		
Loader communication		
Digital input 1		Event output 1 (Note 1)
Digital input 2		Event output 2 (Note 1)
Digital input 3		Event output 3
Digital input 4		
RS-485 Communication		
RSP input		

Availability of input and output is based on a model.  
Note 1 In case of independent contact, the part between the event output 1 and the event output 2 is isolated.

**2. Preventive measures against noise of instrument power supply**

(1) Reduction of noise

Even though the noise is small, the noise filter is used to eliminate the effect of the noise as much as possible.

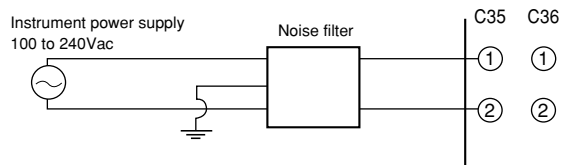

(2) When noise is excessive

If a large amount of noise exists, appropriate isolation transformer and line filter are used to eliminate the effect of the noise.

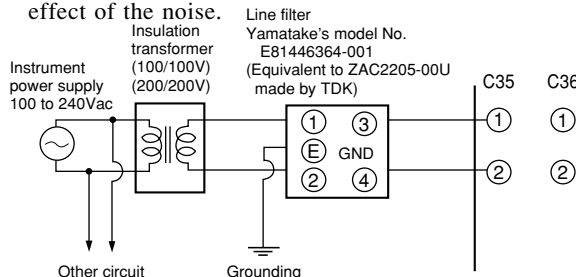

**3. Installation environment noise sources and preventive measures**

Generally, the following may be the noise sources in the installation environment:  
Relay and contact, electromagnetic coil, solenoid valve, power supply line (particularly, 100Vac or more), motor commutator, phase angle control SCR, radio communication device, welding machine, high-voltage ignitor, etc.

**Preventive measures against fast rise noise**

Use of CR filter is effective to prevent fast rise noise.  
Recommended filter:  
Yamatake's model No. **81446365-001**  
(Equivalent to 953M500333311 made by Matsuo Electric.)

**4. Wiring precautions**

- After taking the noise preventive measures, do not bundle the primary and secondary power cables together or put both power cables in the same conduit or duct.
- Keep the input/output and communication lines 50 cm or more away from the power lines and power supply lines having a voltage of 100Vac or more. Additionally, do not put these lines together in the same conduit or duct.

**5. Inspection after wiring**

After the wiring work has been completed, always inspect and check the wiring status. Great care should be taken since incorrect wiring may cause the instrument to malfunction or severe personal injury.

**⚠ RESTRICTIONS ON USE**

This product has been designed, developed and manufactured for general-purpose application in machinery and equipment. Accordingly, when used in the applications outlined below, special care should be taken to implement a fail-safe and/or redundant design concept as well as a periodic maintenance program.

- Safety devices for plant worker protection
- Start/stop control devices for transportation and material handling machines
- Aeronautical/aerospace machines
- Control devices for nuclear reactors

Never use this product in applications where human safety may be put at risk.

Specifications are subject to change without notice.



**Yamatake Corporation**  
**Advanced Automation Company**  
**International Business Headquarters**

Totate International Building  
2-12-19 Shibuya Shibuya-ku  
Tokyo 150-8316 Japan  
URL: <http://www.yamatake.com>

Printed in Japan. (H)  
1st Edition: Issued in Jan., 2004

This has been printed on recycled paper. (01)