

# Power Gate Unit (Thyristor Type Power Regulator) PGU 410 User's Manual

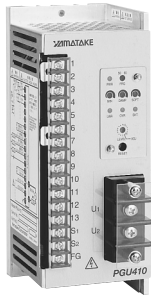

Thank you for purchasing the Power Gate Unit (Thyristor type power regulator) PGU410. This manual contains information for ensuring correct use of the PGU410. It also provides necessary information for installation, maintenance, and troubleshooting. This manual should be read by those who design and maintain devices that use the PGU410. Be sure to keep this manual nearby for handy reference.

## RESTRICTIONS ON USE

This product has been designed, developed and manufactured for general-purpose application in machinery and equipment. Accordingly, when used in applications outlined below, special care should be taken to implement a fail-safe and/or redundant design concept as well as a periodic maintenance program.

- Safety devices for plant worker protection
- Start/stop control devices for transportation and material handling machines
- Aeronautical/aerospace machines
- Control devices for nuclear reactors

Never use this product in applications where human safety may be put at risk.

## REQUEST

Ensure that this User's Manual is handed over to the user before the product is used.

Copying or duplicating this User's Manual in part or in whole is forbidden. The information and specifications in this User's Manual are subject to change without notice.

Considerable effort has been made to ensure that this User's Manual is free from inaccuracies and omissions. If you should find any inaccuracies or omissions, please contact Yamatake Corporation.

In no event is Yamatake Corporation liable to anyone for any indirect, special or consequential damages as a result of using this product.

©2004 Yamatake Corporation ALL RIGHTS RESERVED

## SAFETY PRECAUTIONS

Safety precautions are for ensuring safe and correct use of this product, and for preventing injury to the operator and other people or damage to property. You must observe these safety precautions. Also, be sure to read and understand the contents of this manual.



## WARNING

Warnings are indicated when mishandling this product might result in death or serious injury to the user.



## CAUTION

Cautions are indicated when mishandling this product might result in minor injury to the user, or only physical damage to this product.



## WARNING

- Never touch any terminal with the power turned ON. Additionally, care should be taken since the electricity is not discharged completely and the terminal may be electrically live even though the power is turned OFF.
- Turn off the circuit breaker to completely shut down the external power supply to this unit before proceeding for any maintenance service of this unit. The unit is still under energized state even though it is under operation stop status by the operation command input.
- Set the frequency selector switch correctly to a frequency of the power supply to be used. In particular, if this regulator is operated with 50Hz power supply when this selector switch is set at 60Hz, the output tends to increase.
- Do not attempt to touch the heat sink as it remains hot during operation or immediately after operation.
- Do not supply the power before conforming for correct wiring connections. Because incorrect wiring might cause this unit to break or to be put in the hazardous status.



## CAUTION

- Confirm whether the power supply satisfies and conforms within the limits of specification of operating voltage. If any incorrect power supply is connected, the unit may be damaged.
- Do not connect any capacitive load. If any capacitive load is connected, the current increase rate becomes large at power ON, causing the thyristor element to break.
- Do not connect any inductive load having a power factor of 0.5 or less. If such inductive load is connected, the phase deviation between the current and voltage becomes large, causing the phase angle to be controlled incorrectly.
- Do not operate this unit in a poor noise environment. If a surge voltage is applied to the load or power supply, the thyristor element might be turned ON.

## CONVENTIONS USED IN THIS MANUAL

The following conventions are used in this manual:



### Handling Precautions

Handling Precautions indicate items that the user should pay attention to when handling the power gate unit PGU410.



### Note

Note indicates useful information that the user might benefit by knowing.

(1), (2), (3)

The numbers with the parenthesis indicate steps in a sequence or indicate corresponding parts in an explanation.

# 1. Overview

This power gate unit, thyristor type power regulator model PGU410, is a power regulator using the phase angle control system, which is controlled by a control signal input of 4 to 20mA or manual setting device (QN740A101).

# 2. Part names and external dimensions

(Unless otherwise specified particularly, the tolerance is  $\pm 1$ . Unit: mm)

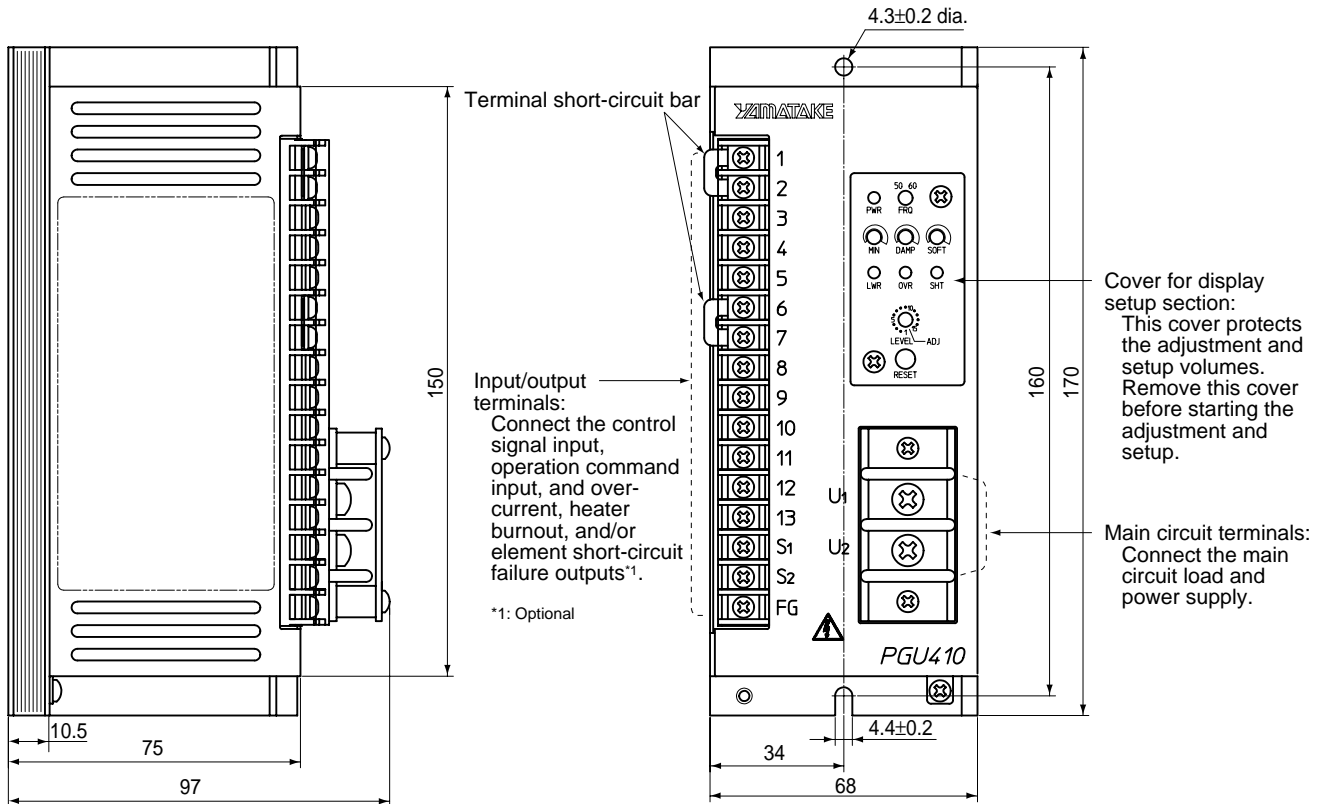

● Detailed description of display setup section (Protection cover for display setup section is removed.)

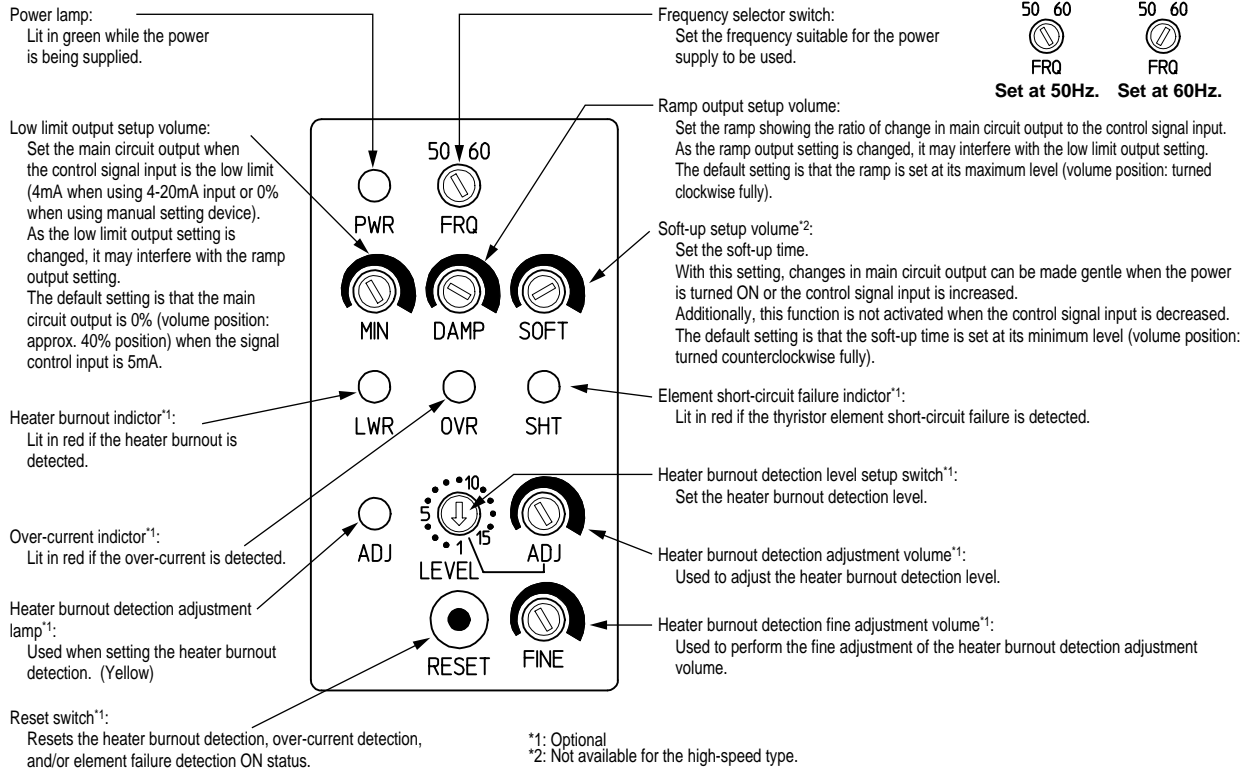

! Handling Precautions

- When setting up the ramp output and low limit output, it is necessary to alternately set up the ramp output and low limit output repeatedly while monitoring the main circuit output since the ramp output and low limit output interfere with each other.

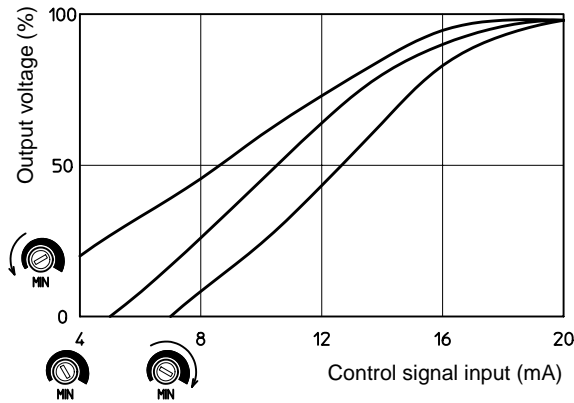

Relationship between low limit output setting and output voltage (Basic type and high-speed type)

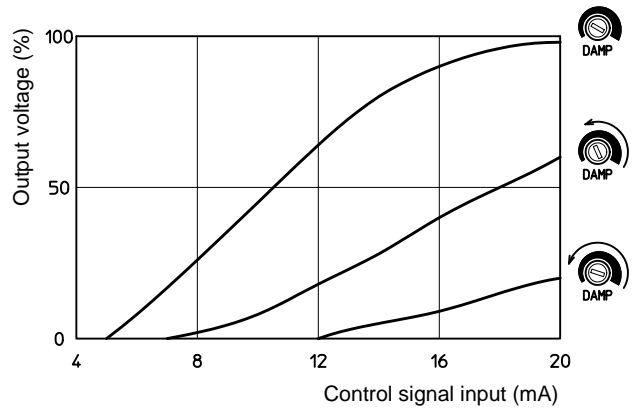

Relationship between ramp output setting and output voltage (Basic type and high-speed type)

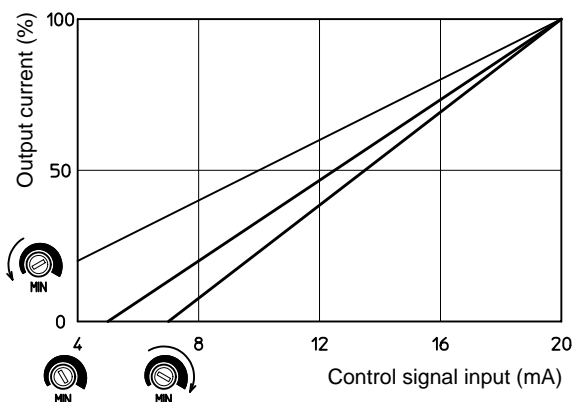

Relationship between low limit output setting and output current (Constant current type)

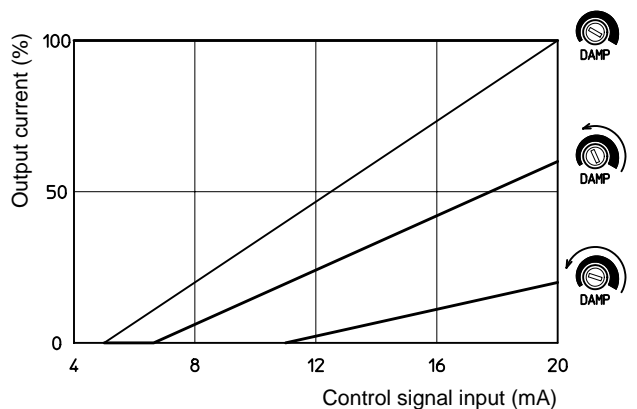

Relationship between ramp output setting and output current (Constant current type)

# 3. External wiring

## ■ Wiring of control signal input and operation command input

● 4 to 20mA input is used.

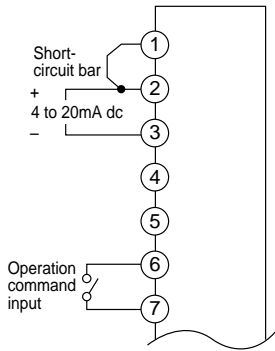

● Ramp setting device (QN740A105) is used.

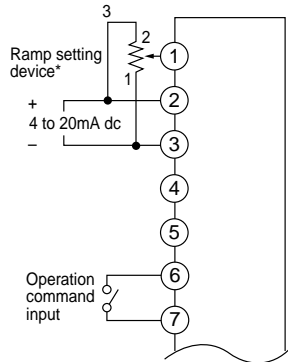

● Manual setting device (QN740A101) is used.

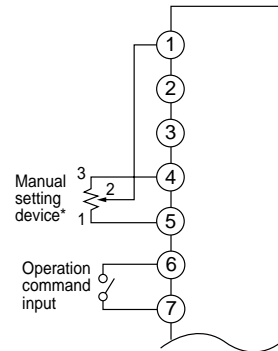

\* Turning the setting device clockwise will increase the set value while turning it counterclockwise will decrease it.

## ■ Wiring of over-current output, heater burnout output, element short-circuit output and reset input (with optional functions mounted)

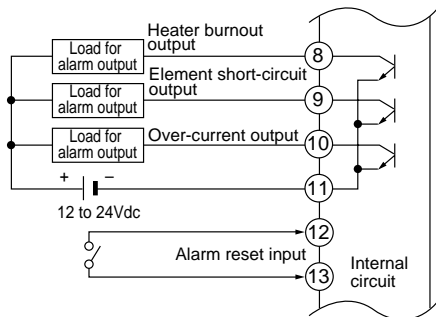

### ! Handling Precautions

- When connecting a semiconductor load, such as programmable controller to the load for the alarm output, always select a proper module meeting the current direction.

## ■ Wiring of power supply and load

● 100/110Vac power supply

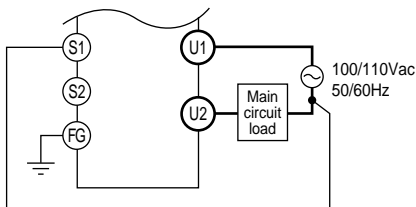

● 200/220Vac power supply

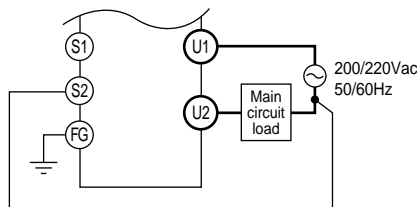

### ! Handling Precautions

- If a voltage of 200/220Vac is applied to the (S1) terminal, this might cause the unit to break.
- Set the frequency selector switch to a frequency of the power supply to be used.

## ■ Wiring Precautions

- Do not use unused terminals as relay terminals.
- Prepare a power supply having a sufficient capacity.
- Keep the low-voltage signal line 50cm or more away from the power line.
- Carry out the grounding work as described below:  
 Grounding resistance : less than 100Ω  
 Grounding cable : Annealed copper cable with cross-sectional area of 2mm<sup>2</sup> or more (AWG14)  
 Length of grounding cable : max. 20m

## ■ Recommended crimp type terminal lug

Always use an appropriate crimp terminal suitable for the following dimensions:

Input/output terminal (M3 screw) (Unit: mm)

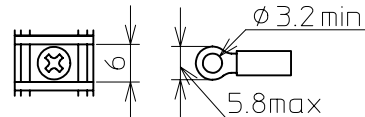

Main circuit terminal (M4 screw) (Unit: mm)

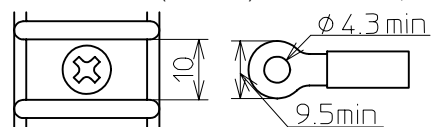

### ! Handling Precautions

- The following shows the proper tightening torque levels of the terminal screws:  
 M3 screw: 0.6N•m or less  
 M4 screw: 1.4N•m or less  
 If the tightening torque exceeds the above level, this might cause the terminal screw to break.

## 4. Setting up the heater burnout detection function

This heater burnout detection function outputs “heater burnout output” and turns on “heater burnout” indicator at the same time if the current flowing through the load becomes the preset value or less.

### ■ Setting up the detection level

- (1) Make sure that the conduction angle of this unit is  $1/6\pi$  or more.  
Set the burnout detection level setup switch (LEVEL) to the ADJ position.  
Fully turn the adjustment volume (ADJ) clockwise.  
Fully turn the fine adjustment volume (FINE) counterclockwise.
- (2) Turn the adjustment volume (ADJ) counterclockwise until the adjustment lamp (ADJ) is lit.
- (3) Turn the fine adjustment volume (FINE) clockwise until the adjustment lamp (ADJ) is lit thinly.
- (4) Set the burnout detection level setup switch (LEVEL) to a required detection level to be set.  
The ratio of the load during setup to the load level to be detected can be set in a range of 25 to 95% at intervals of 5%.

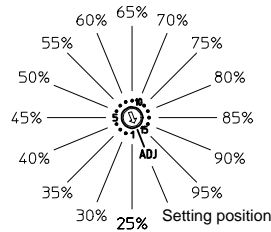
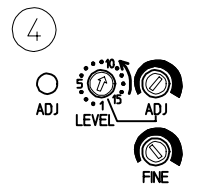
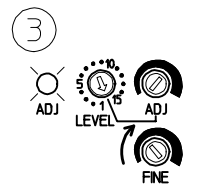
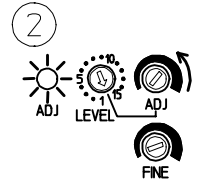
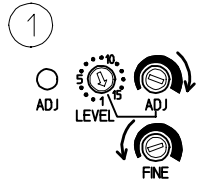

Relationship between heater burnout detection level setup switch and detection level

### 📖 Note

If the control signal input is set to approximately 25% or more when operating the basic type (PGU410A) or high-speed type (PGU410H) with default settings before shipment, it is possible to set the conduction angle waveform of this unit to  $1/6\pi$  or more.

The heater burnout detection signal is output during setup. When the reset inputs are short-circuited, the setup can be made without outputting of the heater burnout detection signal.

### ⚠ Handling Precautions

The resistance value may greatly vary due to the temperature characteristics depending on the heater type. If such heater is used, changes in resistance value caused by temperature must be taken into consideration.

## 5. Troubleshooting

Symptom	Probable cause	Corrective action
Main circuit output signal is not output.	<ul style="list-style-type: none"> <li>Input/output terminals 6 and 7 are not short-circuited. (Operation command inputs are not short-circuited.)</li> <li>When using 4 to 20mA input, input terminals 1 and 2 are not short-circuited.</li> </ul>	<ul style="list-style-type: none"> <li>Correct the wiring.</li> </ul>
Main circuit output does not meet the control signal. Main circuit output is too large or too small.	<ul style="list-style-type: none"> <li>Frequency selector switch setting does not meet the power frequency.</li> </ul>	<ul style="list-style-type: none"> <li>Set the frequency correctly.</li> </ul>

# 6. Specifications

## Model selection table

I	II	III	IV
---	----	-----	----

(Example) PGU410A      015      0      000

I	II	III	IV	Contents
Basic model No.	Rated current	Rated voltage	Option	
PGU410A				Single-phase basic thyristor type power regulator
PGU410H				Single-phase high-speed thyristor type power regulator
PGU410C				Single-phase constant current thyristor type power regulator
	015			Rated current of main circuit: 15A
	030			Rated current of main circuit: 30A
		0		100/110Vac or 200/220Vac *
			000	No optional functions are mounted.
			100	Over-current detection, heater burnout detection, and element short-circuit failure detection functions are provided.

\* The rated voltage is set to 100V-system or 200V-system by changing the tap.

## Specifications

Model	Model	Basic type	High-speed type	Constant current type		
	Basic model No.	PGU410A	PGU410H	PGU410C		
	Rated current of main circuit	15A or 30A				
	Rated voltage of main circuit	100/110Vac or 200/220Vac				
	Feedback	—	—	Constant current characteristic output (Built-in CT, Constant current accuracy: ±3.0% FS)		
Control signal input	Signal	4 to 20mA <sub>dc</sub>				
	Input impedance	240Ω ±5%, 1/2W				
Input	Number of phases and wire method	Single-phase 2-wire method				
	Rated power supply voltage	100/110Vac or 200/220Vac selectable				
	Operational power supply voltage	90 to 121Vac or 180 to 242Vac				
	Rated frequency	50±1Hz or 60±1Hz				
Output	Adjustment range	0 to 98% or more of supply voltage		0 to 100±3% of rated current		
	Min. applicable load	Load with a load current of 1.0A or more				
	Allowable load power factor	0.5 to 1.0 (delay only)				
	Off-state leak current	Rated current of main circuit	15A	30A		
		Leak current value	20mA or less	30mA or less		
	Temperature vs output characteristics (See Fig. below.)	Mounting clearance	Operating temperature range			
				0 to 40°C	50°C	55°C
			Vertical: 80mm	100% or less of rated current	80% or less of rated current	70% or less of rated current
			Horizontal: 100mm	100% or less of rated current	80% or less of rated current	50% or less of rated current
			Vertical: 50mm	100% or less of rated current	70% or less of rated current	40% or less of rated current
			Horizontal: 50mm	100% or less of rated current	50% or less of rated current	0% of rated current
			Vertical: 50mm	100% or less of rated current	50% or less of rated current	0% of rated current

### Handling Precautions

- To use the output current, it is reduced by the mounting clearance and operating ambient temperature. At this time, the graph stated in the temperature vs output characteristics must be referred to.

Setting	Operation command input	Operation	Open: Main circuit output OFF status Short-circuit: Phase angle control status * Even though the operation is in the main circuit output OFF status, the circuit is not shut down completely and voltage is generated by the leak current. Therefore, pay special attention to electric shock.	
		Input type	Dry contact or open collector	
		Input terminal open voltage	8±1V (under operating conditions)	
		Input terminal short-circuit current	12±2mA (under operating conditions)	
		Allowable contact resistance	ON: 500Ω or less (Dry contact is used under operating conditions.) OFF: 100kΩ or more (Dry contact is used under operating conditions.)	
		Allowable open collector input	Allowable open collector, Drop voltage at ON: 2V or less (under operating conditions) Allowable open collector, Leak current at OFF: 0.1mA or less (under operating conditions)	
	Ramp setting	Setting method	Ramp output setup volume (on the front panel of the main unit) or ramp setting device QN740A105 (optional)	
		Setting range	Low limit setting is configured so that the output is 0% at 5mA. • Basic type and high-speed type: 0 to 98% or more (output voltage r.m.s. value to power supply voltage) • Constant current type: 0 to 100%±3% (output current r.m.s. value to rated current)	
	Low limit output setting	Setting method	Low limit output setup volume (on the front panel of the main unit)	
		Setting range	When the ramp setting is configured at 98% or more (basic type and high-speed type) or 100% (constant current type): Output is 20% or more at control signal input of 4mA. to Output is 0% at control signal input of 7mA or more.	
	Manual setting	Setting method	Manual setting device QN740A101 (Optional)	
		Setting range	Basic type and high-speed type: 0 to 98% or more (output voltage r.m.s. value to power voltage) Constant current type: 0 to 100%±3% (output current r.m.s. value to rated current)	
	Soft-up setting (except for high-speed type)	Setting method	Soft-up setup volume (on the front panel of the main unit)	
		Setting range	0.2s or less to 10s or more (with load having power factor of 1.0)	
Frequency setting	Setting method	Frequency selector switch (on the front panel of the main unit)		
	Setting range	50Hz or 60Hz		
Option	Over-current detection function	Output operation	If the main circuit output current becomes 200% or more of the rated current for 0.2s. or longer, the gate of the thyristor is turned OFF, and the alarm output is retained on status by the open collector output and the indicator is lit at the same time.	
		Heater burnout detection function	Heater burnout detection characteristics and operation The detection level can be set in a range of 25 to 95% of the set current (at intervals of 5%). If the current becomes the set current or less, the alarm output is retained on status by the open collector output and the indicator is lit at the same time.	
	Heater burnout detection function	Min. detection phase	Approx. 1/6π	
		Min. setting phase	Approx. 1/6π	
		Min. detection load current	30% of rated current	
		Failure detection operation time	0.5s	
	Element short-circuit failure detection function	Output operation	If the element is turned ON continuously regardless of the control signal, the gate of the thyristor is turned OFF, and the alarm output is retained on status by the open collector output and the indicator is lit at the same time.	
	Open collector output specifications	Output rating	Rated voltage of external supply: 12 to 24Vdc Allowable voltage of external supply: 10 to 29Vdc Max. load current: 70mA Allowable leak current at OFF: 0.1mA or less Drop voltage at ON: 2V or less	
		Output type	Open collector output	
	Alarm reset	Operation	The alarm output is reset when the RESET switch is turned ON, the alarm reset inputs are short-circuited, or the power is turned ON again. (The alarm reset input specifications are the same as those of the operation command input.)	
General specifications	Insulation resistance	50MΩ or more (Insulation resistances between main circuit and chassis, between main circuit and control circuit, and between chassis and control circuit are measured using 500Vdc Megger.)		
	Dielectric strength	Between main circuit and chassis: 2000Vac for 1min Between main circuit and control circuit: 2000Vac for 1min Between chassis and control circuit: 500Vac for 1min		
	Heating value	Approx. 13J/s (The rated current of the main circuit is 15A and the rated output is used.) Approx. 24J/s (The rated current of the main circuit is 30A and the rated output is used.)		
	Cooling method	Natural convection cooling		
	Mask color	Pale purple metallic		
	Mounting	Wall mounting		
	Mass	Approx. 1.1kg		
	Operating conditions	Ambient temperature	0 to 55 °C *1	
		Ambient humidity	10 to 90%RH (No condensation allowed.)	
		Vibration resistance	0.00 to 1.96m/s <sup>2</sup>	
		Shock resistance	0.0 to 4.9m/s <sup>2</sup>	
		Mounting angle	(Reference plane) ±10°	
		Power supply voltage	90 to 121Vac (100/110V terminal is used.) 180 to 242Vac (200/220V terminal is used.)	
		Power frequency	50.0±1.0Hz (Frequency is set at 50Hz.) 60.0±1.0Hz (Frequency is set at 60Hz.)	
Accessories	Terminal short-circuit bar: 2 pcs. (Bars have been mounted between terminals 1 and 2 and between terminal 6 and 7 at shipment.)			

\*1: 0 to 50°C for instrumentation with vertical mounting clearance of 50 mm and horizontal mounting clearance of 10mm.



*Specifications are subject to change without notice.*

**Yamatake Corporation  
Advanced Automation Company**

Totate International Building  
2-12-19 Shibuya Shibuya-ku  
Tokyo 150-8316 Japan

URL: <http://www.yamatake.com>

Printed in Japan.  
1st Edition: Issued in Apr., 2004(A)

*This has been printed on recycled paper. (02)*