

09909E00

Dual-Channel Safety Barriers Series 9002

- Broad product range for all standard applications in the world of automation
- Flexible and space saving single and dual channel versions available
- Time saving installation due to
 - simple snap on DIN-Rail and
 - connection to PE and ground at the same time
- Reduced inventory due to uniform exchangeable fuse
- Installation possible in Zone 2 and Division 2

	Zones					
	0	1	2	20	21	22
Ex i Interfaces	X	X	X	X	X	X
Installation in			X			X

STAHl

R.STAHL safety barriers INTRINSPAK series 9002 are used for various applications in the arena of automation. Based on the broad range of versions and the possibility of various interconnections it offers for almost all tasks.

The safety barriers enable the intrinsic safe operation of HART transmitter, proximity switches, potential-free contacts and temperature sensors, strain gauge, solenoid valves, indicators e.t.c.

The compact design allows a space saving and flexible installation in the cabinet. The mounting is very comfortable and easy due to the fact that installation on the DIN-rail and the contact to the potential equalization is made in one step.



Technical Data	
Certificates	<p>Europe (CENELEC) PTB 01 ATEX 2053 X</p> <p>IECEX IECEX PTB 08.0057X</p> <p>USA FM Approval 3010778 UL Approval E81680</p> <p>Canada CSA 1284580 (LR 43394)</p> <p>Russia GOST R CTB 04.B00764</p> <p>Ukraine ISCVE</p> <p>Belarus Gospromnadzor</p> <p>Kazakhstan JSC</p>
Explosion protection	<p>Europe (CENELEC) ⊕ II 3 (1) G Ex nA [ia Ga] IIC/IIB T4 Gc ⊕ II (1) D [Ex ia Da] IIIC</p> <p>USA I.S. circuits for: Class I, II, III, Division 1, Groups A, B, C, D, E, F, G I.S. circuits for: Class I, Zone 0, Group IIC Class I, Division 2, Groups A, B, C, D Class I, Zone 2, Group IIC</p> <p>Canada I.S. circuits for: Class I, Groups A, B, C, D; Class II, Groups E, F, G; Class III Class I, Division 2, Groups A, B, C, D Class I, Zone 2, Groups IIC</p>
Installation	in Zone 2, Division 2 and in safe area
Enclosure material	Polyamide 6 GF
Type of protection	according to IEC 60529
	terminal enclosure: IP20 housing: IP40
Connection	4 cage terminals, each maximum 1.5 mm ² flexible / solid 2 PA-terminals, each maximum 4 mm ² flexible / solid
Ambient temperature	- 20 ... + 60 °C
Storage	- 20 ... + 75 °C
Maximum relative humidity	95 % mean, no dewing
Leakage current at U _N	≤ 2 µA (if not stated otherwise)
Temperature effect	≤ 0.25 % / 10 K
Frequency	at resistive current limitation: at I _m ≤ 50 mA ≤ 50 kHz at I _m > 50 mA ≤ 100 kHz at electronic current limitation: ≤ 10 kHz
Weight	approx. 0.115 kg

Selection Table

Version	Description	Type	Page
Dual-channel barriers	• Allows the connection of regulated power supplies, U_N	9002/11	4
	• Application specific for the connection of 3-wire NPN, voltage output sensors • Low operational current	9002/11	5
	• Application specific for 4/20 mA transmitters with a 1-5 V input in the control room • Design includes high tolerance 250 Ω resistor	9002/11	6
	• Allows the connection of regulated power supplies, U_N	9002/00	7
	• Application specific for use with strain gauge load cells • One positive polarity channel and one negative polarity channel in one unit	9002/10	8
	• Application specific for the connection of RTDs • High resistance tolerance in each channel, 20 $\Omega \pm 0.1$ • Low temperature coefficient < 50 ppm/K • Allows the connection of regulated power supplies, U_N	9002/22	9
	• Allows the connection of regulated power supplies, U_N	9002/22	10
	• Diode return barrier for supply and return signals in one unit with very small entity current (I_o) addition from the second channel • Allows the connection of unregulated power supplies, U_N , to channel 1 • Operational current limited to 35 mA	9002/13	11
	• Diode return barrier for supply and return signals in one unit with very small entity current (I_o) addition from the second channel • Allows the connection of regulated power supplies, U_N	9002/13	12
	• Diode return barrier for supply and return signals in one unit with very small entity current (I_o) addition from the second channel • Operational current limited to 40 mA at 250 Ω load • Allows the connection of unregulated power supplies, U_N , to channel 1	9002/13	13
	• Diode return barrier for DC current return signals with very small entity current (I_o) addition • Suitable for dry contact and floating 4/20 mA signal returns • Both channels are positive polarity.	9002/33	14
	• Diode return barrier for DC current return signals with very small entity current (I_o) addition • Application specific for passive 4/20 mA signals (from 4-wire transmitters) with isolated analog input at the control system • One positive polarity channel and one negative polarity channel	9002/34	15
	• Allows the connection of a voltage, U_N • Suitable for voltage signals	9002/77	16

Dual-Channel Safety Barriers Polarity: + / +

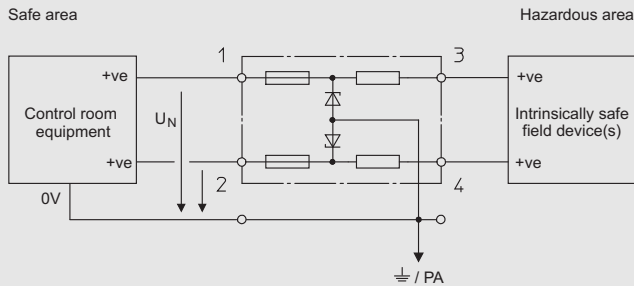

- Allows the connection of regulated power supplies, U_N
- Approved for installation in Division 2 and Zone 2

05820E01

Selection Table

Channel	U_N	R_{min}	R_{max}	I_{max}	Safety Data							Order number
					U_o	I_o	P_o	IIC		IIB		
	V	Ω	Ω	mA	V	mA	mW	L _o mH	C _o μ F	L _o mH	C _o μ F	
1 2 1+2	9 9 --	1043 1043 --	1156 1156 --	7.7 7.7 --	12 12 12	12 12 24	40 40 70	240 240 63	1.41 1.41 1.1	850 850 230	9 9 7.1	9002/11-120-024-001
1 2 1+2	10 1 --	45 45 --	52 52 --	192 19 --	13 1.6 13	321 39 360	1040 16 1170	0.19 24 0.17	1 100 0.79	1.6 91 1.3	6 100 5	9002/11-130-360-001 *)
1 2 1+2	10 10 --	953 953 --	978 978 --	10 10 --	13.7 13.7 13.7	14.5 14.5 29	50 50 100	160 160 43	0.79 0.79 0.67	560 560 160	5 5 4.18	9002/11-137-029-001
1 2 1+2	16 16 --	1423 1423 --	1576 1576 --	10 10 --	19.9 19.9 19.9	15 15 30	75 75 150	160 160 40	0.223 0.223 0.223	560 560 150	1.42 1.42 1.42	9002/11-199-030-001
1 2 1+2	22.5 17.5 --	321 416 --	358 463 --	62 37 --	26 20 26	87 51 138	570 260 850	2.7 14 0.81	0.099 0.22 0.087	15.4 54 5.1	0.77 1.41 0.67	9002/11-260-138-001
1 2 1+2	25 25 --	321 321 --	358 358 --	69 69 --	28 28 28	93 93 186	650 650 1300	2 2 --	0.083 0.083 --	13 13 2.8	0.65 0.65 0.551	9002/11-280-186-001
1 2 1+2	25 6 --	321 59 --	358 68 --	69 88 --	28 9.6 28	89 180 269	630 430 1050	2.2 0.6 --	0.083 3.6 --	14 5 0.56	0.65 26 0.62	9002/11-280-293-001

*) Maximum leakage $I_{leak} \leq 10 \mu A$

Note Application example see General - Standard Applications

Functional and Maximum Safety Values

U_N	Nominal voltage	I_{max}	Maximum current through the safety barrier	P_o	Maximum power
R_{min}	Minimum resistance of the safety barrier	U_o	Maximum voltage	L_o	Maximum permissible external inductance
R_{max}	Maximum resistance of the safety barrier	I_o	Maximum current	C_o	Maximum permissible external capacity



Dual-Channel Safety Barriers Polarity: + / +

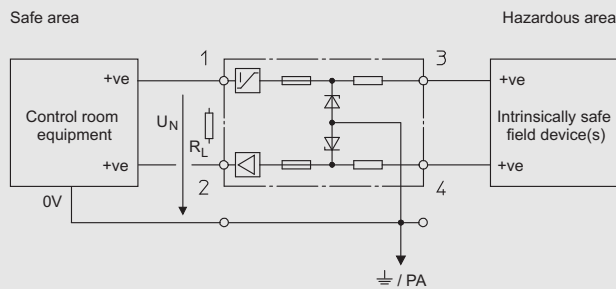

- Application specific for the connection of 3-wire NPN, voltage output sensors
- Low operational current
- Approved for installation in Division 2 and Zone 2

05823E01

Selection Table

Channel	U _N	R _{min}	R _{max}	I _{max}	Safety Data								Order number
					U _o		P _o	IIC		IIB			
					V	mA	mW	L _o	C _o	L _o	C _o		
1	24	264	296	8	28	109	760	1.3	0.083	9	0.65	9002/11-280-112-001	
2	24	11979	12221	23	28	3	20	1.3	0.083	150	0.65		
1+2	--	--	--	--	28	112	780	0.76	0.065	84	0.551		

Functional and Maximum Safety Values

U _N	Nominal voltage	I _{max}	Maximum current through the safety barrier	P _o	Maximum power
R _{min}	Minimum resistance of the safety barrier	U _o	Maximum voltage	L _o	Maximum permissible external inductance
R _{max}	Maximum resistance of the safety barrier	I _o	Maximum current	C _o	Maximum permissible external capacity

Dual-Channel Safety Barriers Polarity: + / +

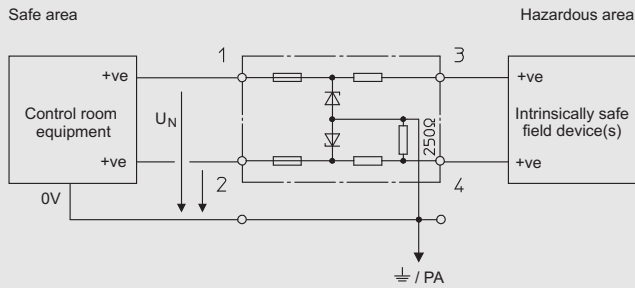

- Application specific for 4/20 mA transmitters with a 1-5 V input in the control room
- Design includes high tolerance 250 Ω resistor
- Approved for installation in Division 2 and Zone 2

05820E01

Selection Table

Channel	U _N	R _{min}	R _{max}	I _{max}	Safety Data								Order number
					U _o	I _o	P _o	IIC		IIB			
					V	mA	mW	L _o	C _o	L _o	C _o		
1	25	321	358	69	28	89	630	2.2	0.083	14	0.65	9002/11-280-293-021	
2	6	59	68	88	9.6	180	430	0.6	3.6	5	26		
1+2	--	--	--	--	28	269	1050	--	--	0.56	0.62		

Functional and Maximum Safety Values

U _N	Nominal voltage	I _{max}	Maximum current through the safety barrier	P _o	Maximum power
R _{min}	Minimum resistance of the safety barrier	U _o	Maximum voltage	L _o	Maximum permissible external inductance
R _{max}	Maximum resistance of the safety barrier	I _o	Maximum current	C _o	Maximum permissible external capacity



Dual-Channel Safety Barriers Polarity: - / -

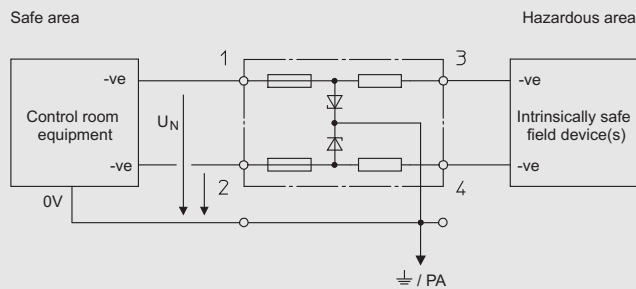

- Allows the connection of regulated power supplies, U_N
- Approved for installation in Division 2 and Zone 2

05822E02

Selection Table

Channel	U_N	R_{min}	R_{max}	I_{max}	Safety Data								Order number
					U_o		I_o		IIC		IIB		
					V	Ω	V	mA	L_o	C_o	L_o	C_o	
1 2 1+2	9 9 --	1043 1043 --	1156 1156 --	7.7 7.7 --	12 12 12	12 12 24	40 40 70	240 240 63	1.41 1.41 1.1	850 850 230	9 9 7.1	9002/00-120-024-001	
1 2 1+2	22.5 17.5 --	321 416 --	358 463 --	62 37 --	26 20 26	87 51 138	540 245 785	2.7 14 0.81	0.099 0.22 0.087	15.4 54 5.1	0.77 1.41 0.67	9002/00-260-138-001	
1 2 1+2	25 25 --	321 321 --	358 358 --	69 69 --	28 28 28	93 93 186	650 650 1300	2 2 --	0.083 0.083 --	13 13 2.8	0.65 0.65 0.551	9002/00-280-186-001	

Note Application example see General - Standard Applications

Functional and Maximum Safety Values

U_N	Nominal voltage	I_{max}	Maximum current through the safety barrier	P_o	Maximum power
R_{min}	Minimum resistance of the safety barrier	U_o	Maximum voltage	L_o	Maximum permissible external inductance
R_{max}	Maximum resistance of the safety barrier	I_o	Maximum current	C_o	Maximum permissible external capacity

Dual-Channel Safety Barriers Polarity: + / -

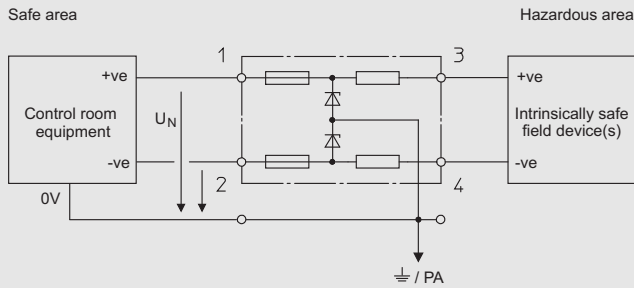

- Application specific for use with strain gauge load cells
- One positive polarity channel and one negative polarity channel in one unit
- Approved for installation in Division 2 and Zone 2

05821E02

Selection Table

Channel	U _N V	R _{min} Ω	R _{max} Ω	I _{max} mA	Safety Data								Order number
					U _o V	I _o mA	P _o mW	IIC		IIB			
								L _o mH	C _o μF	L _o mH	C _o μF		
1 2 1+2	6 6 --	490 490 --	543 543 --	11 11 --	9.3 9.3 18.7	20 20 20	50 50 90	90 90 90	3.9 3.9 0.27	330 330 330	29 29 1.64	9002/10-187-020-001	
1 2 1+2	6 6 --	42 42 --	49 49 --	122 122 --	9.3 9.3 18.7	270 270 270	630 630 1260	0.23 0.23 0.23	3.9 3.9 0.27	2.2 2.2 2.2	29 29 1.64		9002/10-187-270-001

Note Application example see General - Standard Applications

Functional and Maximum Safety Values

U _N	Nominal voltage	I _{max}	Maximum current through the safety barrier	P _o	Maximum power
R _{min}	Minimum resistance of the safety barrier	U _o	Maximum voltage	L _o	Maximum permissible external inductance
R _{max}	Maximum resistance of the safety barrier	I _o	Maximum current	C _o	Maximum permissible external capacity



Dual-Channel Safety Barriers Polarity: ~ / ~

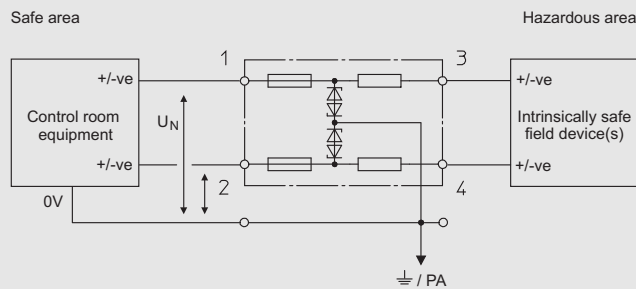

- Application specific for the connection of RTDs
- High resistance tolerance in each channel, $20 \Omega \pm 0.1$
- Low temperature coefficient $< 50 \text{ ppm/K}$
- Allows the connection of regulated power supplies, U_N
- Approved for installation in Division 2 and Zone 2

05835E02

Selection Table

Channel	U_N	R_{min}	R_{max}	I_{max}	Safety values								Order number
					U_o	I_o	P_o	IIC		IIB			
					V	mA	mW	L_o	C_o	L_o	C_o		
1	0.7	19	20.1	33	1.6	150	60	1.3	100	7	1000	9002/22-032-300-111 *)	
2	0.7	19	20.1	33	1.6	150	60	1.3	100	7	1000		
1+2	1.4	--	--	--	3.2	300	120	0.2	100	1.8	1000		

*) Maximum leakage $I_{leak} \leq 10 \mu A$

Note Application example see General - Standard Applications

Functional and Maximum Safety Values

U_N	Nominal voltage	I_{max}	Maximum current through the safety barrier	P_o	Maximum power
R_{min}	Minimum resistance of the safety barrier	U_o	Maximum voltage	L_o	Maximum permissible external inductance
R_{max}	Maximum resistance of the safety barrier	I_o	Maximum current	C_o	Maximum permissible external capacity

Dual-Channel Safety Barriers Polarity: ~ / ~

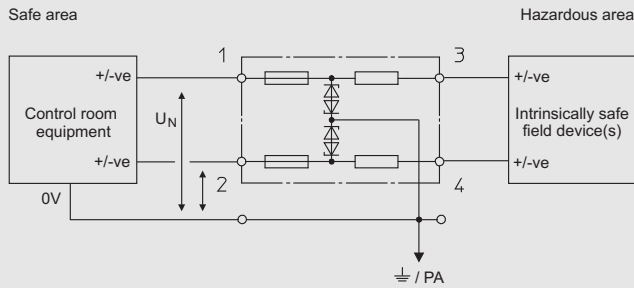

- Allows the connection of regulated power supplies, U_N
- Approved for installation in Division 2 and Zone 2

05845E02

Selection Table

Channel	U_N	R_{min}	R_{max}	I_{max}	Safety values								Order number
					U_o	I_o	P_o	IIC		IIB			
					V	mA	mW	L_o	C_o	L_o	C_o		
	V	Ω	Ω	mA	V	mA	mW	mH	μF	mH	μF		
1	5.5	84	95	57	7.9	100	198	4	8.8	15	115	9002/22-158-200-001	
2	5.5	84	95	57	7.9	100	198	4	8.8	15	115		
1+2	11	--	--	--	15.8	200	395	0.5	0.478	4	2.88		
1	9	1043	1156	7.7	12	12	40	240	1.41	850	9	9002/22-240-024-001	
2	9	1043	1156	7.7	12	12	40	240	1.41	850	9		
1+2	18	--	--	--	24	24	80	41	0.125	145	0.93		
1	9	158	177	50	12	80	240	6	1.41	22	9	9002/22-240-160-001	
2	9	158	177	50	12	80	240	6	1.41	22	9		
1+2	18	--	--	--	24	160	480	0.7	0.125	4	0.93		

Functional and Maximum Safety Values

U_N	Nominal voltage	I_{max}	Maximum current through the safety barrier	P_o	Maximum power
R_{min}	Minimum resistance of the safety barrier	U_o	Maximum voltage	L_o	Maximum permissible external inductance
R_{max}	Maximum resistance of the safety barrier	I_o	Maximum current	C_o	Maximum permissible external capacity



Dual-Channel Safety Barriers Safety Barrier Polarity: + / Signal Barrier Polarity: +

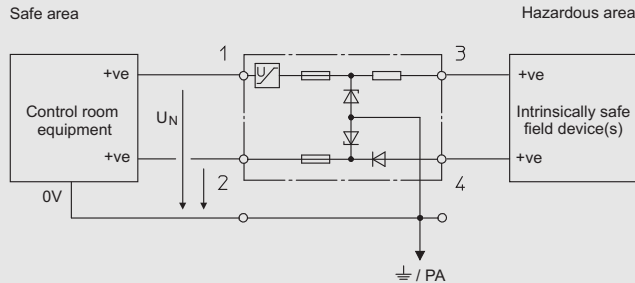

- Diode return barrier for supply and return signals in one unit with very small entity current (I_o) addition from the second channel
- Operational current limited to 40 mA at 250 Ω load
- Allows the connection of unregulated power supplies, U_n , to channel 1
- Approved for installation in Division 2 and Zone 2

05439E02

Selection Table

Channel	U_N V	R_{min} Ω	R_{max} Ω	I_{max} mA	ΔU V	Safety Data							Order number
						U_o V	I_o mA	P_o mW	IIC L_o mH, C_o μ F		IIB L_o mH, C_o μ F		
1	20 - 35	216	243	86	--	25.2	118	740	1.3	0.107	7.4	0.82	9002/13-252-121-041 ^{*)}
2	22	--	--	--	3.5	25.2	0	20	50	0.107	150	0.82	
1+2	--	--	--	--	--	25.2	121	760	1.25	0.104	7.35	0.8	

^{*)} Only for channel 1: leakage at 24 V / 35 V $I_{leak} \leq 1$ mA / 10 mA

Note Application example see General - Standard Applications

Functional and Maximum Safety Values

U_N	Nominal voltage	ΔU	Additional voltage drop through the safety barrier	L_o	Maximum permissible external inductance
R_{min}	Minimum resistance of the safety barrier	U_o	Maximum voltage	C_o	Maximum permissible external capacity
R_{max}	Maximum resistance of the safety barrier	I_o	Maximum current		
I_{max}	Maximum current through the safety barrier	P_o	Maximum power		

Dual-Channel Safety Barriers
 Safety Barrier Polarity: + / Signal Barrier Polarity: +

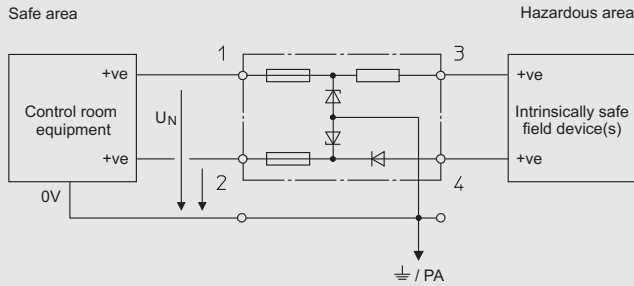

- Diode return barrier for supply and return signals in one unit with very small entity current (I_o) addition from the second channel
- Allows the connection of regulated power supplies, U_N
- Approved for installation in Division 2 and Zone 2

05826E02

Selection Table

Channel	U_N	R_{min}	R_{max}	I_{max}	ΔU	Safety Data								Order number
						U_o	I_o	P_o	IIC		IIB			
	V	Ω	Ω	mA	V	V	mA	mW	L_o	C_o	L_o	C_o		
						mH	μF	mH	μF	mH	μF			
1	16	95	108	148	--	19.9	222	1100	0.39	0.223	3.18	1.42	9002/13-199-225-001 *)	
2	16	--	--	--	2	19.9	3	15	1000	0.223	1000	1.42		
1+2	--	--	--	--	--	19.9	225	1120	0.37	0.213	3.15	1.38		
1	24	321	358	67	--	28	90	630	2.2	0.083	14	0.65	9002/13-280-093-001	
2	24	--	--	--	2	28	3	21	50	0.083	150	0.65		
1+2	--	--	--	--	--	28	93	651	2	0.08	13	0.636		
1	24	269	290	82	--	28	107	749	1.35	0.083	9.6	0.65	9002/13-280-110-001	
2	24	--	--	--	2	28	3	21	50	0.083	150	0.65		
1+2	--	--	--	--	--	28	110	770	1.25	0.08	9	0.635		

*) Only for channel 2: maximum leakage $I_{leak} \leq 10 \mu A$

Note Application example see General - Standard Applications

Functional and Maximum Safety Values

U_N	Nominal voltage	ΔU	Additional voltage drop through the safety barrier	L_o	Maximum permissible external inductance
R_{min}	Minimum resistance of the safety barrier	U_o	Maximum voltage	C_o	Maximum permissible external capacity
R_{max}	Maximum resistance of the safety barrier	I_o	Maximum current		
I_{max}	Maximum current through the safety barrier	P_o	Maximum power		



Dual-Channel Safety Barriers Safety Barrier Polarity: + / Signal Barrier Polarity: +

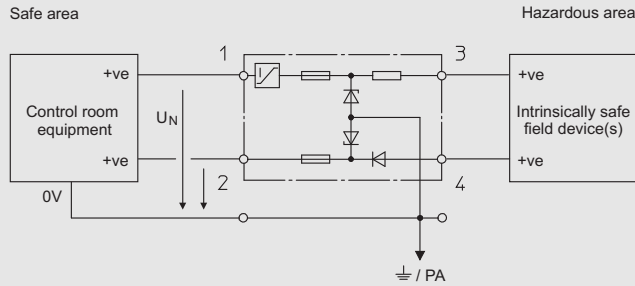

- Diode return barrier for supply and return signals in one unit with very small entity current (I_o) addition from the second channel
- Allows the connection of unregulated power supplies, U_N , to channel 1
- Operational current limited to 35 mA
- Approved for installation in Division 2 and Zone 2

05827E02

Selection Table

Channel	U_N V	R_{min} Ω	R_{max} Ω	I_{max} mA	ΔU V	Safety Data								Order number
						U_o V	I_o mA	P_o mW	IIC		IIB			
									L_o mH	C_o μF	L_o mH	C_o μF		
1	20 - 35	292	327	107	--	28	97	679	1.8	0.083	12	0.65	9002/13-280-100-041 *)	
2	26	--	--	--	3.5	28	0	21	50	0.083	150	0.65		
1+2	--	--	--	--	--	28	100	700	1.55	0.08	11	0.635		

*) Only for channel 1: leakage at $< 26 V / > 26 V$ $I_{leak} \leq 1 mA / 35 mA$

Functional and Maximum Safety Values

U_N	Nominal voltage	ΔU	Additional voltage drop through the safety barrier	L_o	Maximum permissible external inductance
R_{min}	Minimum resistance of the safety barrier	U_o	Maximum voltage	C_o	Maximum permissible external capacity
R_{max}	Maximum resistance of the safety barrier	I_o	Maximum current		
I_{max}	Maximum current through the safety barrier	P_o	Maximum power		

Dual-Channel Safety Barriers
Signal Barrier Polarity: + / Signal Barrier Polarity: +

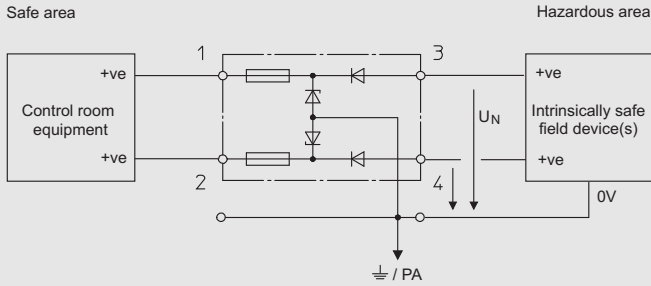

- Diode return barrier for DC current return signals with very small entity current (I_o) addition
- Suitable for dry contact and floating 4/20 mA signal returns
- Both channels are positive polarity.
- Approved for installation in Division 2 and Zone 2

Selection Table

Channel	U_N V	I_{max} mA	ΔU V	Safety Data						Order number
				U_o V	I_o mA	IIC L_o mH	C_o μF	IIB L_o mH	C_o μF	
1	25.5	60	3.5 *)	28	0	1000	0.083	1000	0.65	9002/33-280-000-001
2	25.5	60	3.5 *)	28	0	1000	0.083	1000	0.65	
1+2	--	--	--	28	0	1000	0.083	1000	0.65	

*) 2,5 V to 20 mA

Functional and Maximum Safety Values

U_N	Nominal voltage	U_o	Maximum voltage	C_o	Maximum permissible external capacity
I_{max}	Maximum current through the safety barrier	I_o	Maximum current		
ΔU	Additional voltage drop through the safety barrier	L_o	Maximum permissible external inductance		



Dual-Channel Safety Barriers Signal Barrier Polarity: + / Signal Barrier Polarity: -

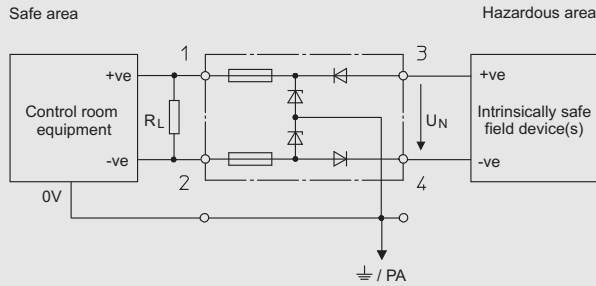

- Diode return barrier for DC current return signals with very small entity current (I_o) addition
- Application specific for passive 4/20 mA signals (from 4-wire transmitters) with isolated analog input at the control system
- One positive polarity channel and one negative polarity channel
- Approved for installation in Division 2 and Zone 2

Selection Table

Channel	U_N V	I_{max} mA	ΔU V	Safety Data						Order number
				U_o V	I_o mA	IIC		IIB		
						L_o mH	C_o μF	L_o mH	C_o μF	
1	+ 16	100	3.5 ^{*)}	28	0	1000	0.22	1000	1.14	9002/34-280-000-001
2	- 5	100	3.5 ^{*)}	8	0	1000	8.4	1000	100	
1+2	21	--	--	28	0	1000	0.083	1000	0.65	

^{*)} 2,5 V to 20 mA

Note Application example see General - Standard Applications

Functional and Maximum Safety Values

U_N	Nominal voltage	U_o	Maximum voltage	C_o	Maximum permissible external capacity
I_{max}	Maximum current through the safety barrier	I_o	Maximum current		
ΔU	Additional voltage drop through the safety barrier	L_o	Maximum permissible external inductance		

Dual-Channel Safety Barriers
Star Barrier / Star Barrier

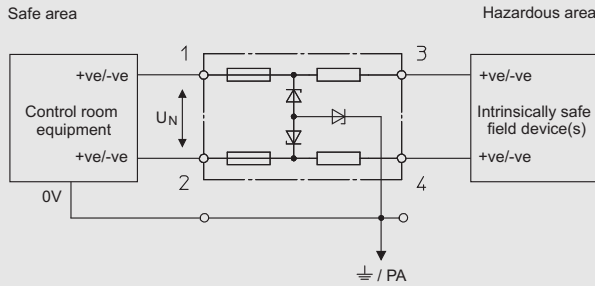

- Allows the connection of a voltage, U_N
- Suitable for voltage signals
- Approved for installation in Division 2 and Zone 2
- AC version

05836E02

Selection Table

Channel	U_N V	R_{min} Ω	R_{max} Ω	Safety Data								Order number
				U_o V	I_o mA	P_o mW	IIC		IIB			
							L_o mH	C_o μF	L_o mH	C_o μF		
1	--	492	545	9.3	20	50	90	4.1	330	31	9002/77-093-040-001	
2	--	492	545	9.3	20	50	90	4.1	330	31		
1+2	6	--	--	9.3	40	90	23	4.1	87	31		
1	--	71	82.1	9.3	150	350	1.3	4.1	7	31	9002/77-093-300-001	
2	--	71	82.1	9.3	150	350	1.3	4.1	7	31		
1+2	6	--	--	9.3	300	700	0.2	4.1	1.8	31		
1	--	60	69.2	10	200	500	0.5	3	4	20.2	9002/77-100-400-001	
2	--	60	69.2	10	200	500	0.5	3	4	20.2		
1+2	6	--	--	10	400	1000	0.15	3	0.8	20.2		
1	--	111	126	15	150	560	1.3	0.58	7	3.55	9002/77-150-300-001	
2	--	111	126	15	150	560	1.3	0.58	7	3.55		
1+2	12	--	--	15	300	1130	0.2	0.58	1.8	3.55		
1	--	321	358	22	73	400	7	0.165	26	1.14	9002/77-220-146-001 ^{*)}	
2	--	321	358	22	73	400	7	0.165	26	1.14		
1+2	18	--	--	22	146	800	1.4	0.165	7.4	1.14		
1	--	159	180	22	148	810	1.35	0.165	7.2	1.14	9002/77-220-296-001 ^{*)}	
2	--	159	180	22	148	810	1.35	0.165	7.2	1.14		
1+2	18	--	--	22	296	1630	0.24	0.165	1.84	1.14		
1	--	657	730	28	47	330	10.1	0.083	30	0.65	9002/77-280-094-001	
2	--	657	730	28	47	330	10.1	0.083	30	0.65		
1+2	24	--	--	28	94	660	1.96	0.083	12.5	0.65		





^{*)} Ambient temperature - 20 ... + 50 °C

Note Application example see General - Standard Applications

Functional and Maximum Safety Values

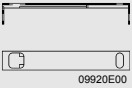
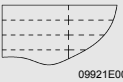
U_N	Nominal voltage	U_o	Maximum voltage	L_o	Maximum permissible external inductance
R_{min}	Minimum resistance of the safety barrier	I_o	Maximum current	C_o	Maximum permissible external capacity
R_{max}	Maximum resistance of the safety barrier	P_o	Maximum power		

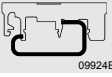

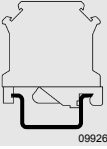
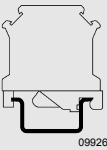
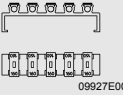
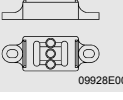
Accessories and Spare Parts				
Designation	Illustration	Description	Order number	Weight kg
Back-up fuse	 09919E00	for all safety barriers Series 9001, 9002 and 9004 unit: 5 pcs.	158964	0.008
Holder for labels	 09920E00		158977	0.002
Labelling paper	 09921E00	perforated, for typing Format: DIN A4	158973	0.005
Adaptor	 09922E00		158826	0.006
Mounting attachment moulded plastic	 09924E00		165283	0.004
DIN rail	 07104E00	NS 35 / 15 (meter length)	103714	1.410
Earth terminal	 09926E00	USLKG 5 (wire range $\leq 4 \text{ mm}^2$)	112760	0.012
Earth terminal	 09926E00	USLKG 6 N (wire range $\leq 6 \text{ mm}^2$)	112599	0.030
Fuse holder	 09927E00		158834	0.020
Insulating stand off	 09928E00	for rail NS 35/15	158828	0.023

Dimensional Drawings (All Dimensions in mm) - Subject to Alterations

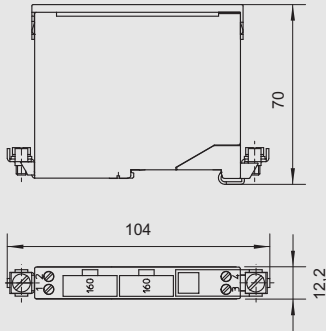

09929E00

Safety barriers 9001, 9002, 9004

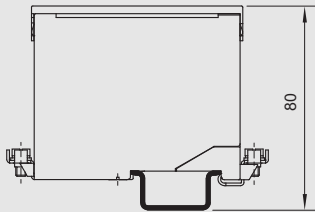

09930E00

Safety barriers 9001, 9002, 9004
mounting on
DIN rail NS 35/15 (acc. to EN 50 022)

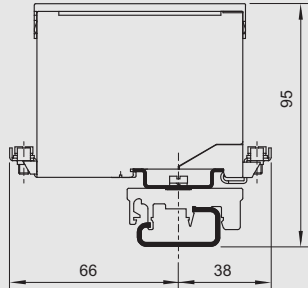

09932E00

Safety barriers 9001, 9002, 9004
mounting on
DIN rail NS 32 (acc. to EN 50 035)
by means of adaptor and
mounting attachment, moulded plastic

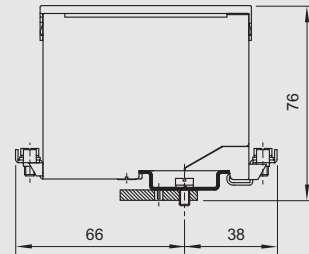

09933E00

Safety barriers 9001, 9002, 9004
mounting on
mounting plate by means of adaptor

We reserve the right to make alterations to the technical data, weights, dimensions, designs and products available without notice. The illustrations cannot be considered binding.

